

**01-101**  
TROEMNER  
Size: 245 mm

½



**01-102**  
DEJERINE  
Size: 200 mm

½



**01-103**  
DEJERINE  
With Needle  
Size: 210 mm

½



**01-104**  
TAYLOR  
Size: 195 mm

½



**01-105**  
BERLINER  
Size: 200 mm

½

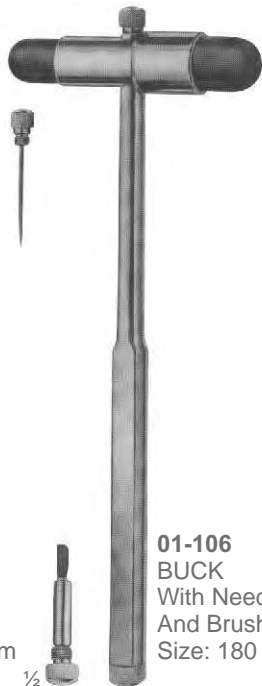

**01-106**  
BUCK  
With Needle  
And Brush  
Size: 180 mm

½

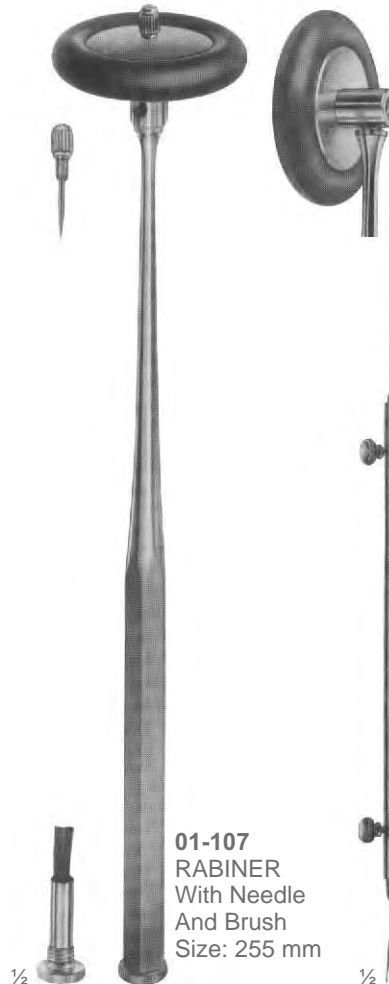

**01-107**  
RABINER  
With Needle  
And Brush  
Size: 255 mm

½



**01-108**  
ALY  
Size: 190 mm

½



**01-109**  
WARTENBERG  
Pinwheel For  
Neurological  
Examination  
Size: 185 mm

½



**01-110**  
PINARD (Aluminum)  
Size: 155 mm

1/2



**01-111**  
aus Holz (Wooden)  
Size: 145 mm

1/2



**01-112**  
BOWLES  
Stethoscope  
With Diaphragm

1/4

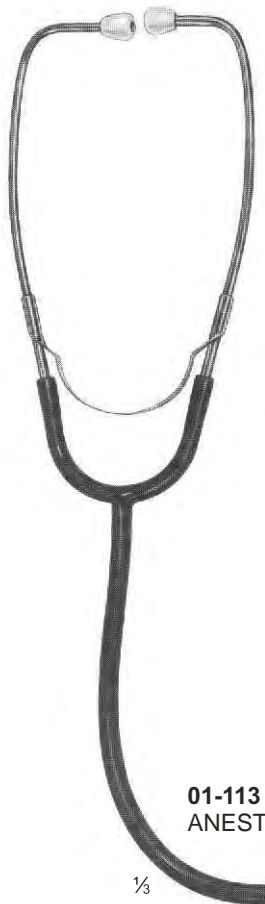

**01-113**  
ANESTOPHON

1/3



**01-114**  
FORD-BOWLES  
Duel Chest Piece  
With Two Outlets

1/4



**01-115**  
BOWLES

1/4



**01-116**  
ZIEGLER Ø mm  
Head mirror only  
with rubber coating



**01-117**  
ZIEGLER Ø mm  
Head mirror only  
with metal coating



**01-118**  
ZIEGLER  
Head band of plastic black

**01-119**  
ZIEGLER  
Head band of plastic white



**01-120**  
MURPHY  
Head band of celluloid, white

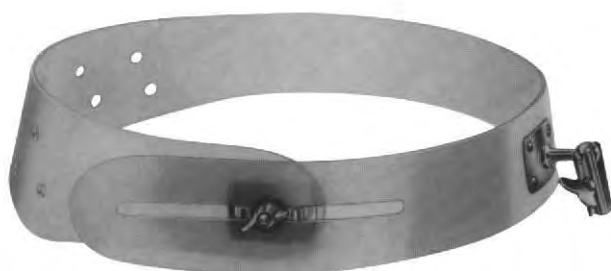

**01-121**  
Head band of plastic,  
white, soft pattern



**01-122**  
Head mirror with black  
plastic head band.



**01-123**

CLAR

Head light, 6 volt, with adjustable joint,  
white celluloid head band,  
cord with plugs for transformer

**01-124**

White celluloid head band, only, for

**01-125**

Spare mirror only, for



**01-126**  
spare bulb

**01-127**

CLAR

Head light, 6 volt, with adjustable joint,  
white celluloid head band, with foam rubber pad  
and cord with plugs for transformer

**01-128**

White celluloid head band, only, for head light

**01-129**

mirror only, for head light

spare foam rubber pad, for head band



**01-130**  
spare bulb

**01-131**

CLAR

Head light, 6 volt, with adjustable joint,  
white plastic head band,  
cord with plugs for transformer



**01-132**  
spare bulb

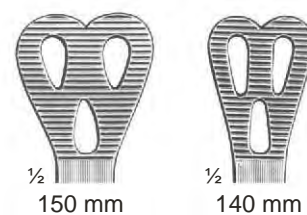
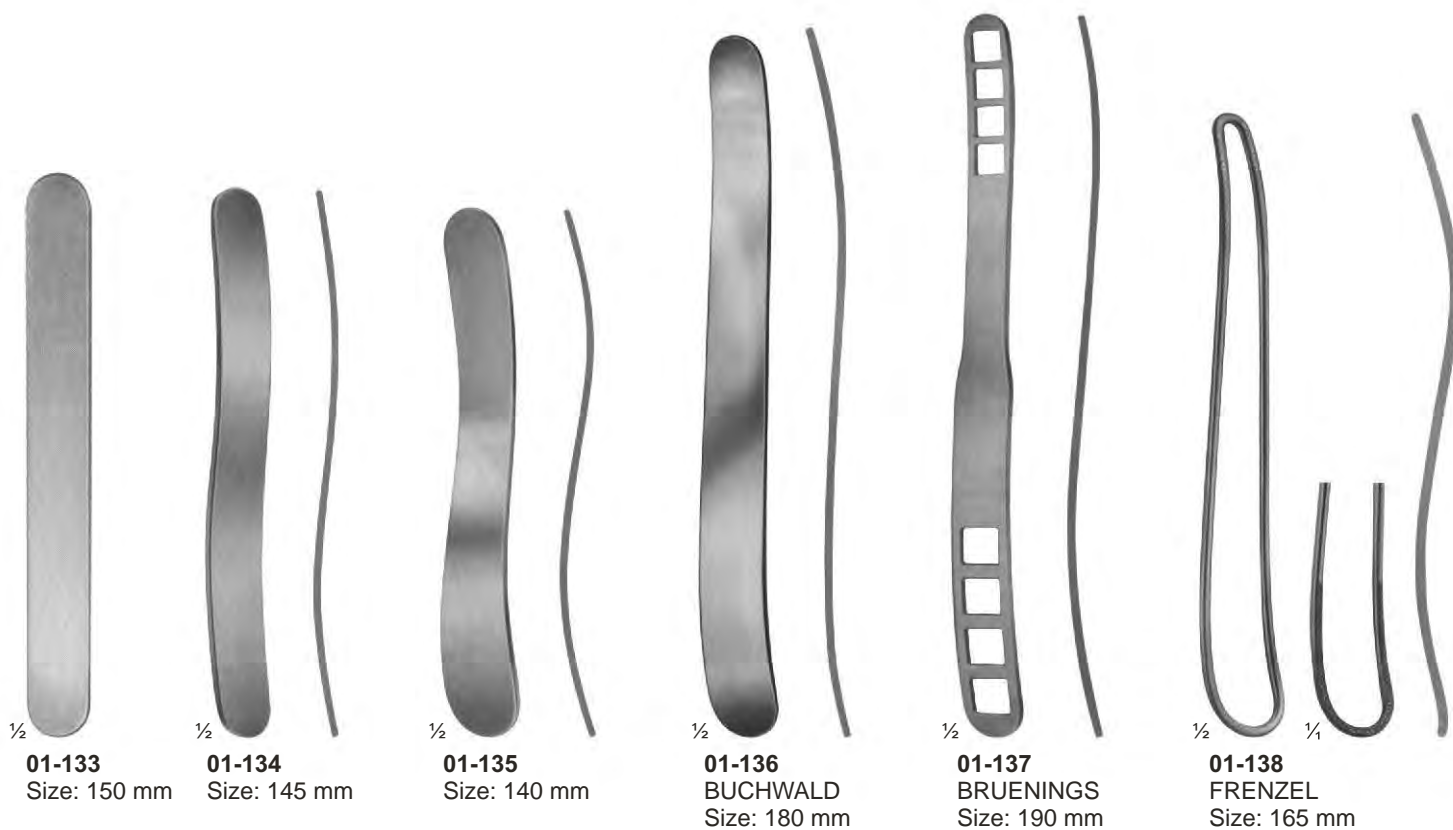



1/2

**01-144**  
SCHIMMELBUSCH  
Ether Mask



1/2

**01-145**  
HEISTER  
Mouth Gag  
Size: 130 mm



1/2

**01-146**  
FERGUSSON-ACKLAND  
Mouth Gag  
Size: 145 mm



1/2

**01-147**  
DENHARDT  
Mouth Gag With Silicon  
Inserts, Interchangeable  
Size: 125 mm



1/2

**01-148**  
ROSER KONIG  
Mouth Gag  
Size: 160 mm, 185 mm

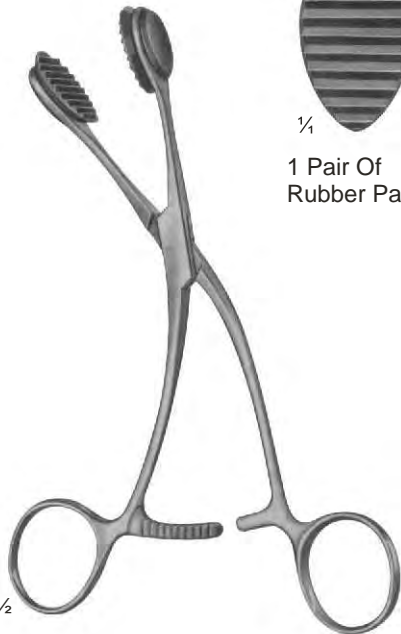

1/2

**01-149**  
YOUNG  
Size: 165 mm



1/4

1 Pair Of  
Rubber Pads

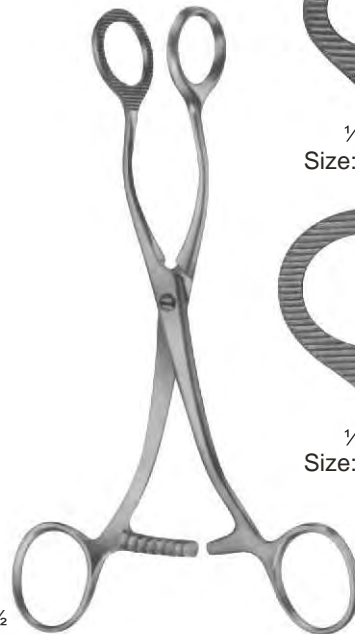

1/2

**01-150**  
COLLIN  
Size: 160 mm, 170 mm



1/4

Size: 160 mm



1/4

Size: 170 mm

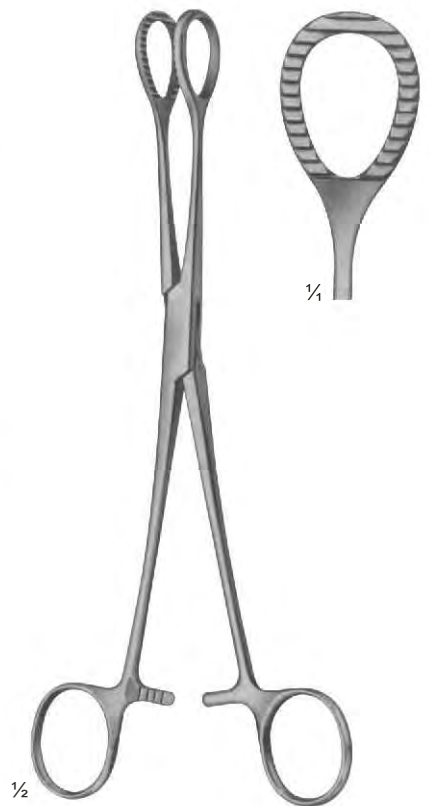

1/2

**01-151**  
HEYWOOD-SMITH modif.  
Size: 215 mm



**01-152**  
FRANCKE  
Automatic Blood Lancet



**01-153**  
KOLLE  
Microscopic Needle Holder  
With Plastic Handle  
Size: 240 mm

Fig. 000

Fig. 00

Fig. 0

Fig. 1

Fig. 2

Fig. 3

Fig. 4

Fig. 5

Fig. 6

Fig. 7

Fig. 8

Fig. 9

Fig. 10



**01-154**  
Laryngeal Mirrors With  
Hexagonal Handle  
Size: 180 mm



**01-155**  
Mirror Handle  
Size: 110 mm



**01-156**  
Mirror Handle  
Size: 105 mm



**01-157**  
MICHEL  
Rhinoscopic Mirrors With  
Interchangeable Mirror Inserts  
Size: 250 mm



**01-158**  
Spare Mirrors Only  
Size: 12 mm



**01-159**  
Spare Mirrors Only  
Size: 14 mm



**01-160 - 162**  
MAGILL



**01-160**  
Infants  
Size: 150 mm



**01-161**  
Children  
Size: 200 mm



**01-162**  
Adults  
Size: 250 mm



**01-163**  
Medium battery handle  
only, 25 mm diam.



**01-163-A**  
Spare bulb  
2.7 volt, for  
otoscopes



**01-163-B**  
Spare bulb  
2.6 volt, for  
ophthalmoscopes



**01-164**  
Otoscope Set, Consists Of  
Battery Handle Without Batteries,  
3 Ear Specula, 1 Bulb In Velvet Lined Case



**01-165**  
Diagnostic Set, Otoscope With Three Specula,  
Nasal Speculum, Lamp Holder, Two Laryngeal  
Mirrors, Tongue Blade Holder



1/3

**01-166**  
**MILLER**  
 Laryngoscope Set, Consists Of Battery Handle ( Without Battery )  
 With Four Miller Laryngoscope Blades

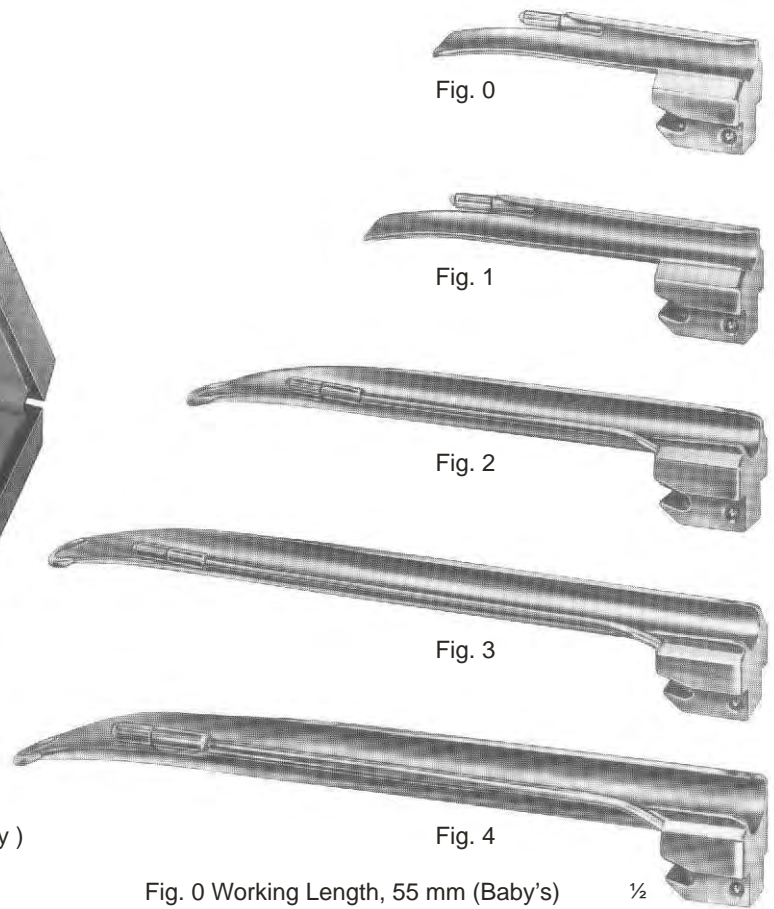

Fig. 0 Working Length, 55 mm (Baby's) 1/2  
 Fig. 1 Working Length, 80 mm (Children's)  
 Fig. 2 Working Length, 130 mm (Adolescent's)  
 Fig. 3 Working Length, 170 mm (Women's)  
 Fig. 4 Working Length, 180 mm (Men's)



1/3

**01-167**  
**GUEDEL-NEGUS**  
 Laryngoscope Set, Consists Of Battery Handle ( Without Battery )  
 With Four Miller Laryngoscope Blades

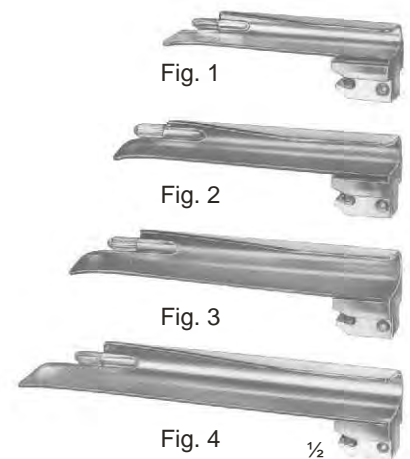

Fig. 1 Working Length, 70 mm (Children's)  
 Fig. 2 Working Length, 90 mm (Adolescent's)  
 Fig. 3 Working Length, 110 mm (Women's)  
 Fig. 4 Working Length, 135 mm (Men's) 1/2



1/3

**01-168**  
McIntosh  
Laryngoscope Set, Consists Of Battery Handle ( Without Battery )  
With Three McIntosh Blades, Fig. 1, Fig. 2, Fig. 3

**01-169**  
McIntosh  
Laryngoscope Set, Consists Of Battery Handle ( Without Battery )  
With Five McIntosh Blades, Fig. 1, Fig. 2, Fig. 3, Fig. 4, Fig. 5

Fig. 0

Fig. 1

Fig. 2

Fig. 3

Fig. 4

1/2

Fig. 0 Working Length, 55 mm (Baby's)  
Fig. 1 Working Length, 75 mm (Children's)  
Fig. 2 Working Length, 90 mm (Adolescent's)  
Fig. 3 Working Length, 110 mm (Women's)  
Fig. 4 Working Length, 135 mm (Men's)



**01-170**  
FOREGGER  
Laryngoscope Set, Consists Of  
Battery Handle ( Without Battery )  
With Three Foregger Blades,  
Fig. 1, Fig. 2, Fig. 3,

**01-171**  
FOREGGER  
Laryngoscope Set, Consists Of  
Battery Handle ( Without Battery )  
With Five Foregger Blades,  
Fig. 1, Fig. 2, Fig. 3, Fig. 4, Fig. 5

1/3

Fig. 1

Fig. 2

Fig. 3

Fig. 4

1/2

Fig. 1 Working Length, 70 mm (Children's)  
Fig. 2 Working Length, 90 mm (Adolescent's)  
Fig. 3 Working Length, 110 mm (Women's)  
Fig. 4 Working Length, 135 mm (Men's)



1/2

**01-172**  
Fiber Optic  
Battery Handle



1/2

**01-173**  
Fiber Optic  
Battery Handle



1/4

**01-174**  
Replacement Lamp  
( Krypton ) 2.5 V



1/4

**01-175**  
Replacement Lamp  
( Halogen ) 2.5 V

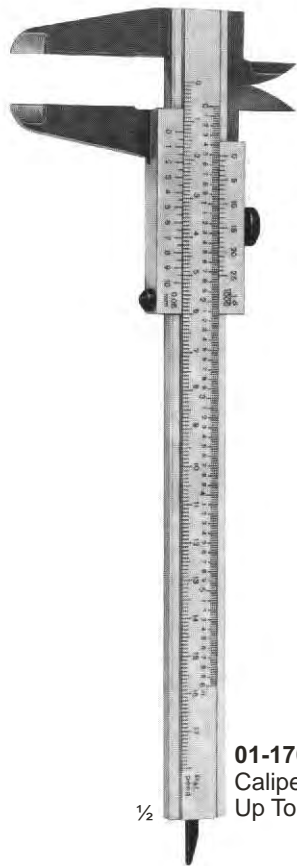

1/2  
**01-176**  
Caliper Of Aluminum  
Up To 180 mm



1/2  
**01-177**  
VERNIER  
Universal Caliper Of Steel  
Up To 120 mm



1/2  
**01-178**  
CAROLL  
Size: 140 mm



1/2  
**01-179**  
TOWNLEY  
Size: 100 mm



1/2  
**01-180**  
COLLIN  
Druck Pressure 72 kg  
Size: 125 mm



1/2  
**01-181**  
BERTILLON  
Caliper For Measuring The Head  
Size: 320 mm



1/4  
**01-182**  
CASTROVIEJO  
Caliper



1/2  
**01-183**  
MOLTGEN  
Goniometer

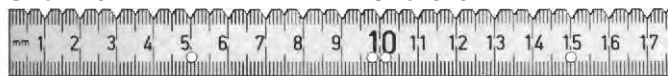

**01-185**  
Size: 150 mm

**01-184**  
Size: 500 mm



1/2

**02-101 - 110**  
Fig. 1 - 10



1/4

**02-101**  
Fig. 1



**02-102**  
Fig. 2



**02-103**  
Fig. 3



**02-104**  
Fig. 4



**02-105**  
Fig. 5



1/4

**02-106**  
Fig. 6



**02-107**  
Fig. 7



**02-108**  
Fig. 8



**02-109**  
Fig. 9



**02-110**  
Fig. 10

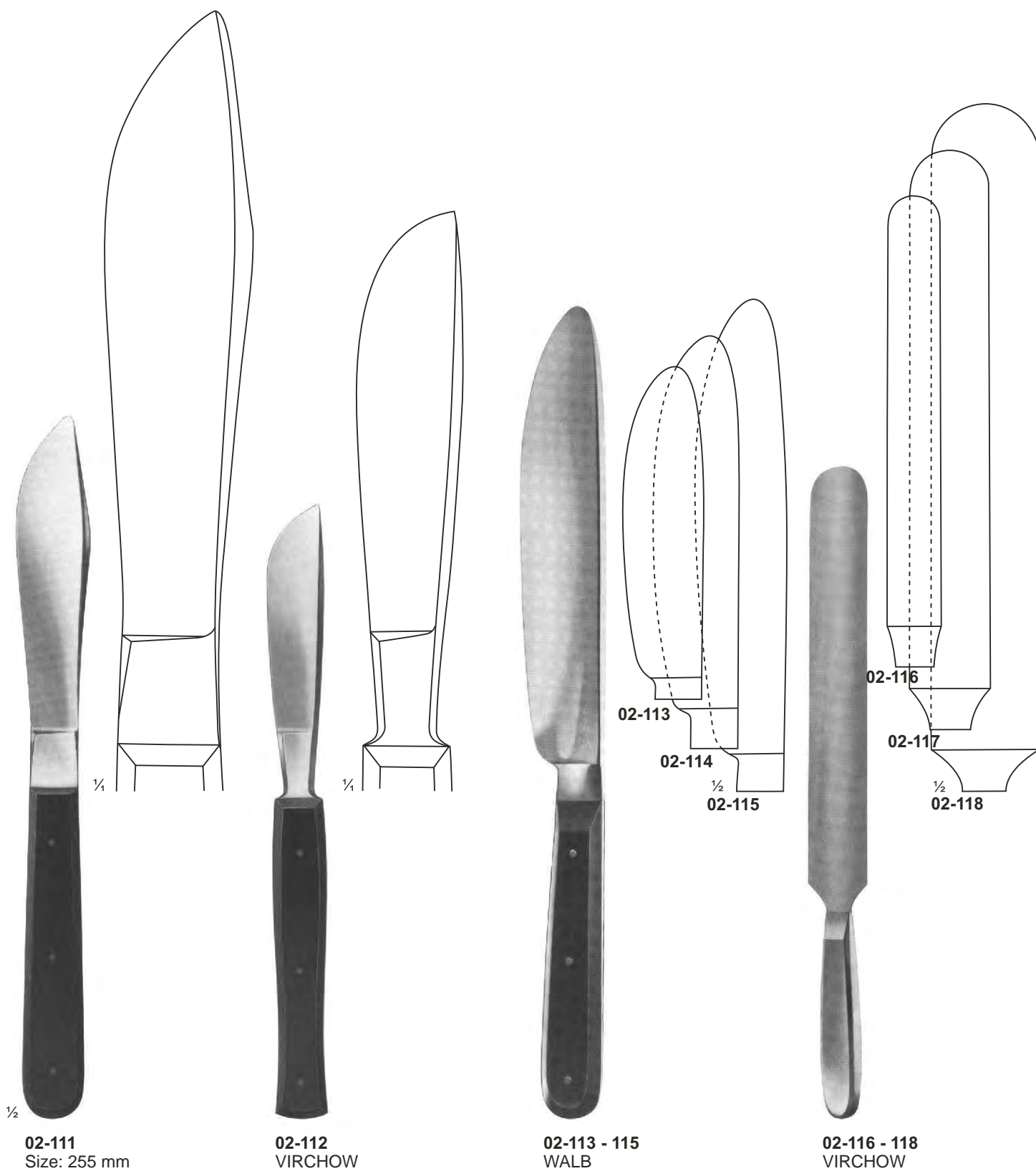

1/2  
**02-111**  
 Size: 255 mm

**02-112**  
 VIRCHOW

**02-113 - 115**  
 WALB

**02-116 - 118**  
 VIRCHOW

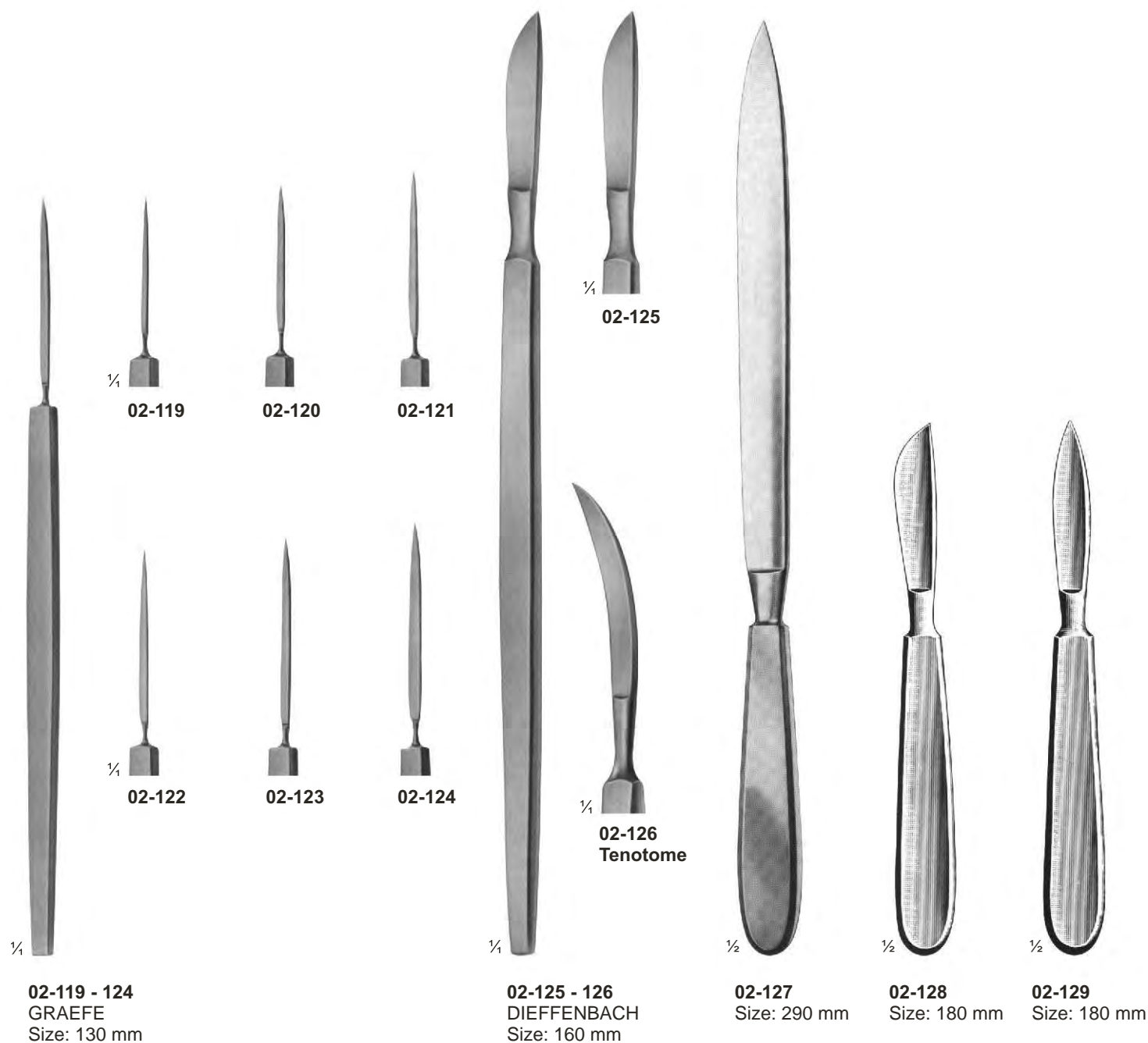

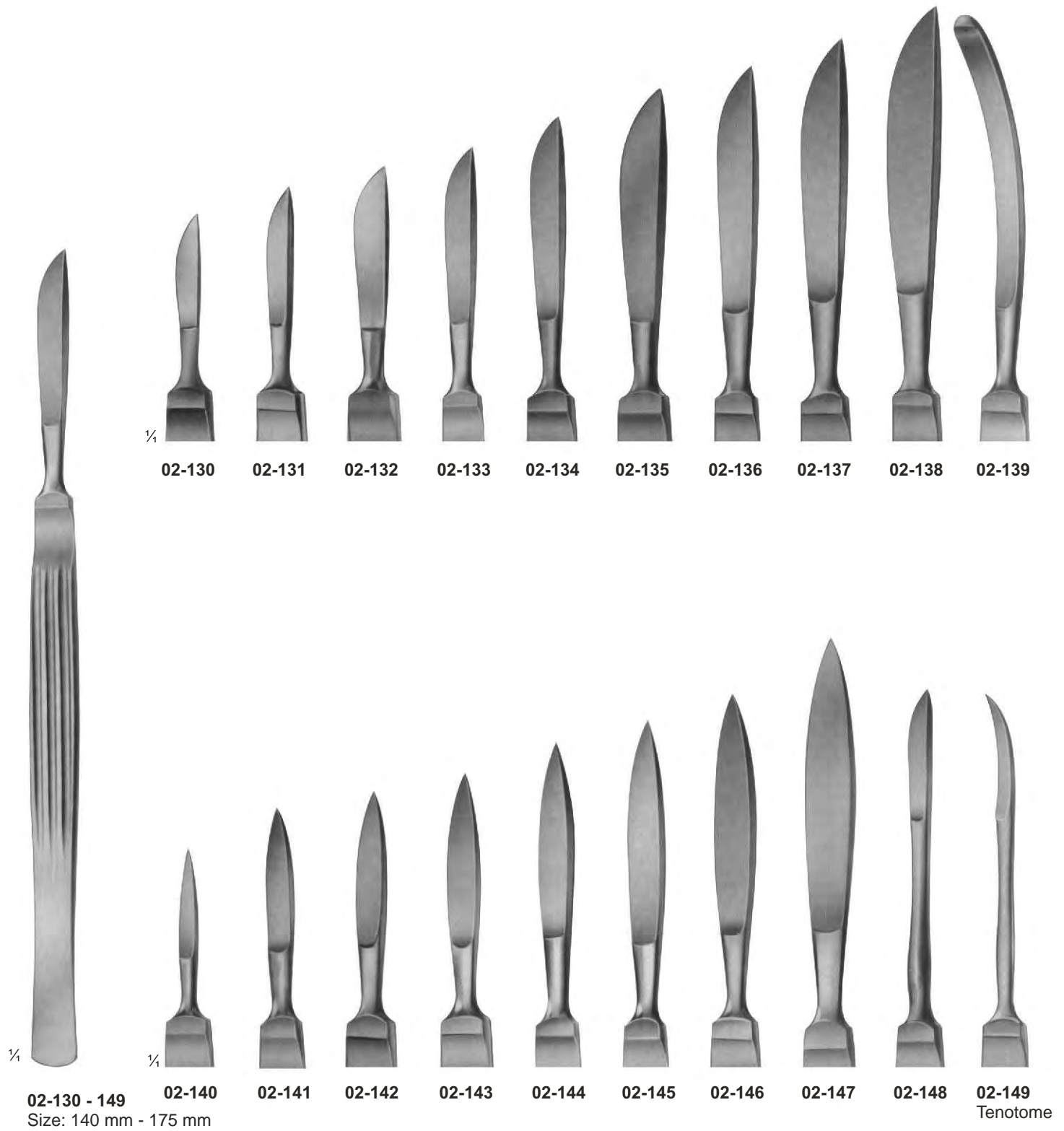



**02-150**  
Size: 130 mm  
**02-151**  
Size: 160 mm  
**02-152**  
Size: 190 mm  
**02-153**  
Size: 200 mm

**02-154**  
CATLIN  
Size: 160 mm  
Blade Length  
Amputating  
Knives

**02-155**  
LANGENBECK  
Size: 120 mm  
Blade Length  
Flap Knives

**02-156**  
Size: 110 mm  
Blade Length  
Interosseous  
Knives

**02-157**  
Size: 55 mm  
Blade Length  
With Raspatory,  
Wooden Handle

**02-158**  
Size: 70 mm  
Blade Length  
Wooden Handle

**02-159**  
Size: 80 mm  
Blade Length  
Metal Handle

**02-160**  
Size: 195 mm  
Blade Length  
Metal Handle

Blade Length  
Amputating Knives



**02-161**  
AYRE  
Size: 235 mm  
Cone Knife

**02-162**  
Size: 230 mm  
Cone Knife

**02-163**  
SEGOND  
Size: 270 mm  
Myomatome

**02-164**  
OLIVECRONA  
Size: 205 mm  
Trigeminal  
Knife

**02-165**  
Size: 230 mm  
Trigeminal  
Knife

**02-166**  
FOWLER  
Size: 200 mm  
Tonsil Knife

**02-167**  
ABRAHAM  
Size: 215 mm  
Tonsil Knife

**02-168**  
BRUNINGS  
Size: 215 mm  
Tonsil Knife

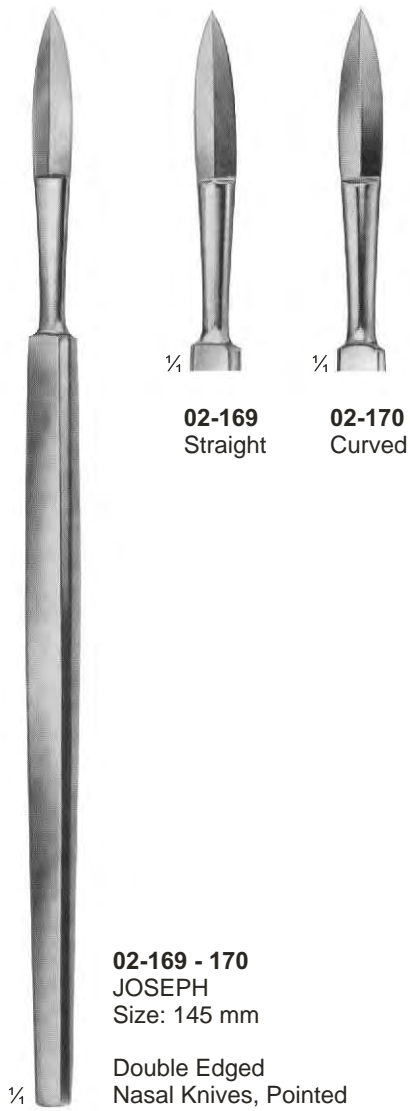

**02-169**  
Straight

**02-170**  
Curved

**02-169 - 170**  
JOSEPH  
Size: 145 mm

Double Edged  
Nasal Knives, Pointed

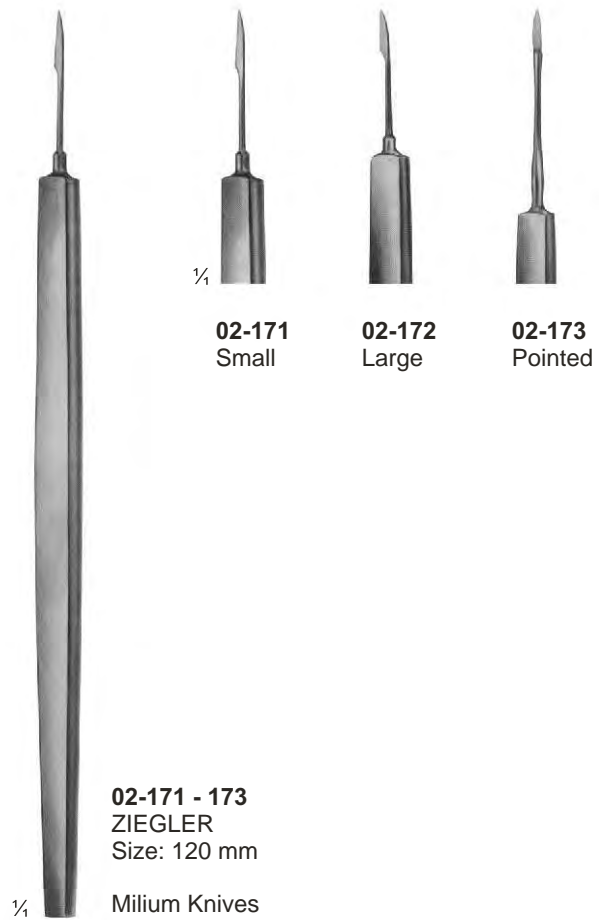

**02-171**  
Small

**02-172**  
Large

**02-173**  
Pointed

**02-171 - 173**  
ZIEGLER  
Size: 120 mm

Milium Knives



**02-174**  
VIDAL  
Lupus Scraper  
Size: 135 mm

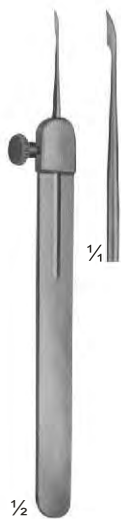

**02-175**  
MONCORPS  
Milium Knives  
Size: 130 mm



**02-176**  
SAALFELD  
Size: 100 mm

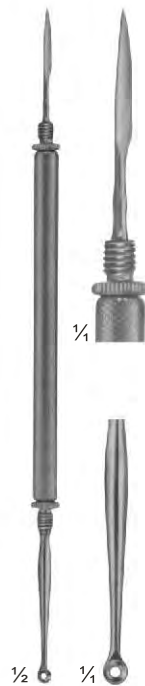

**02-177**  
HEBRA  
Size: 180 mm



**02-178**  
Size: 145 mm



**02-179**  
UNNA  
Size: 145 mm



¼  
**02-180**  
 TROUTMAN-CHRIS  
 Size: 100 mm



¼  
**02-181**  
 TROUTMAN-CHRIS  
 Size: 100 mm



¼  
**02-182**  
 Size: 110 mm



¼  
**02-183**  
 CASTROVIEJO  
 Size: 130 mm



¼  
**02-184**  
 Size: 185 mm

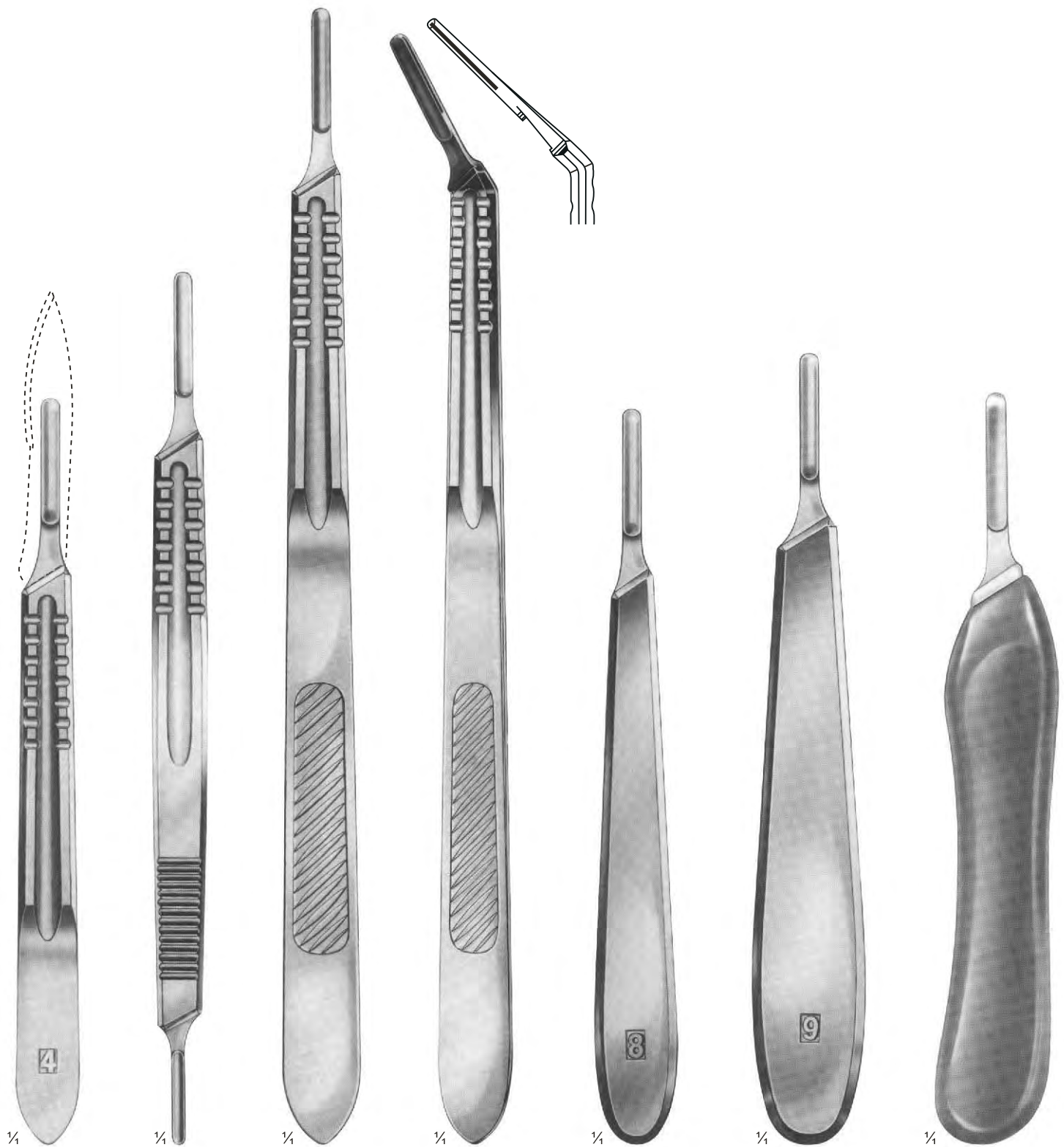

¼  
**02-185**  
 STANDARD  
 No. 4  
 Solid

¼  
**02-186**  
 Double Handel  
 No. 4 + No. 3  
 Solid

¼  
**02-187**  
 No. 4 L  
 Straight  
 Solid

¼  
**02-188**  
 No. 4 L  
 Solid Angled

¼  
**02-189**  
 COLLIN  
 No. 8  
 Hollow

¼  
**02-190**  
 COLLIN  
 No. 9  
 Hollow

¼  
**02-191**  
 Plastic

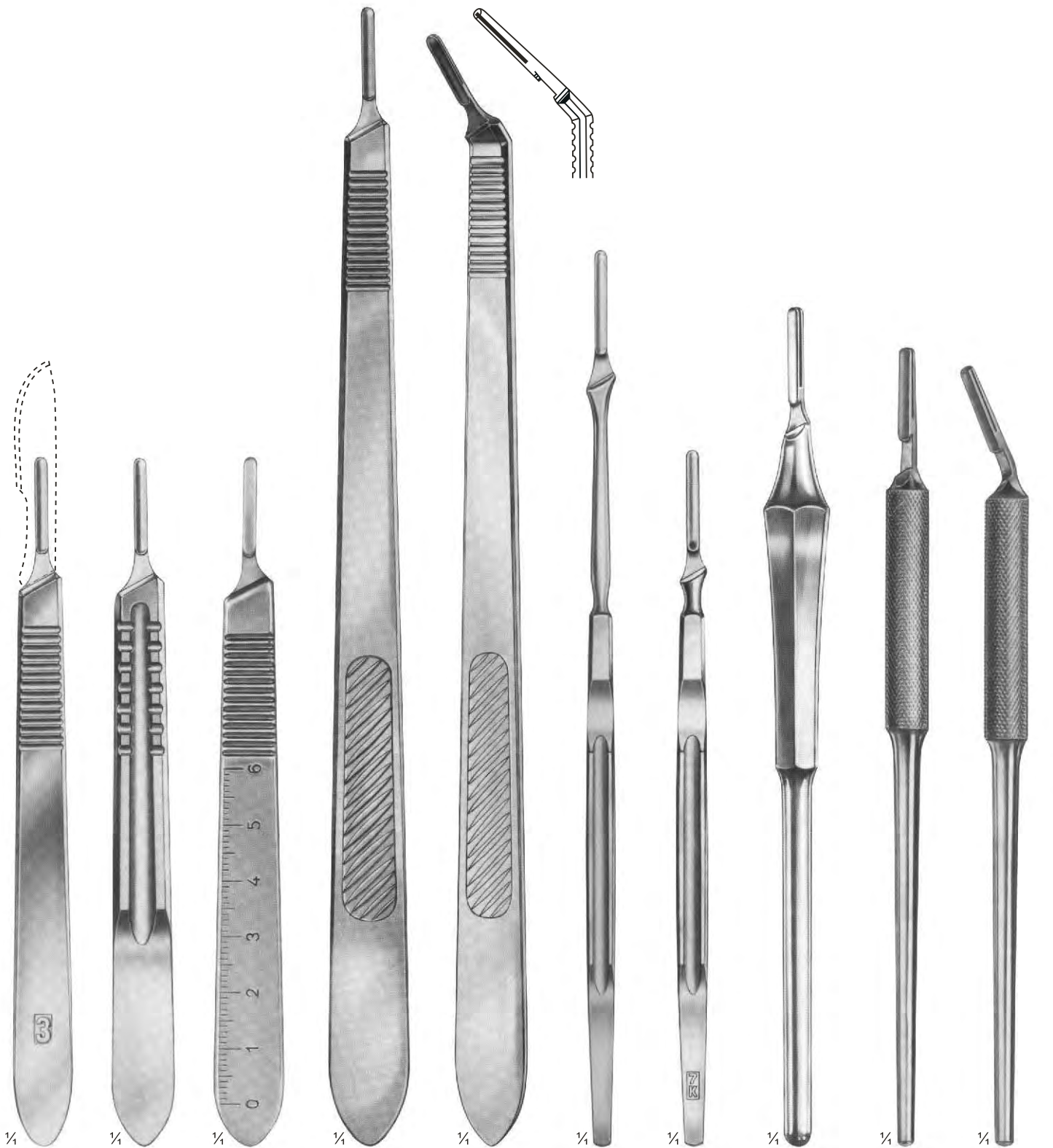

**02-192**  
STANDARD  
No. 3  
Solid

**02-193**  
No. 3  
Solid

**02-194**  
No. 3  
Solid

**02-195**  
No. 3 L  
Straight  
Solid

**02-196**  
No. 3 L  
Angled  
Solid

**02-197**  
No. 7  
Solid

**02-198**  
No. 7 K  
Solid

**02-199**  
Hollow-Round

**02-200**  
No. 3  
Straight  
Solid

**02-201**  
No. 3  
Angled  
Solid

# Micro Scissors, "Spring Type" Flat Handles

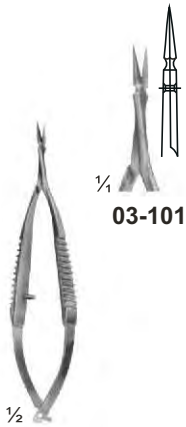

**03-101 - 103**  
VANNAS  
Size: 85 mm



**03-104 - 105**  
CASTROVIEJO  
Size: 95 mm

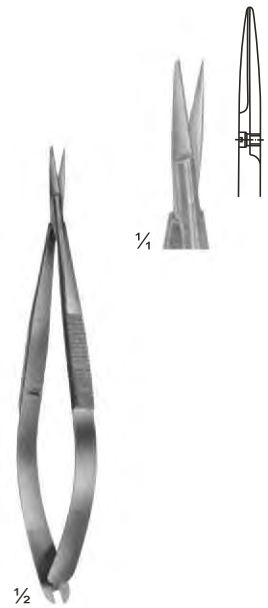

**03-106**  
NOYES  
Size: 125 mm

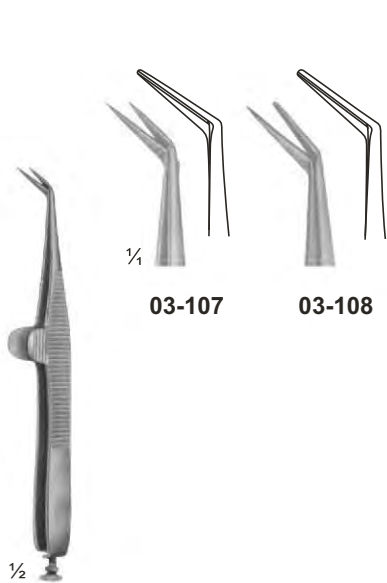

**03-107 - 108**  
WECKER  
Eye Scissor  
Size: 110 mm

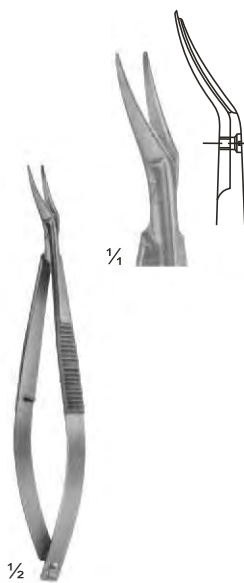

**03-109**  
CASTROVIEJO  
Eye Scissor  
Size: 115 mm

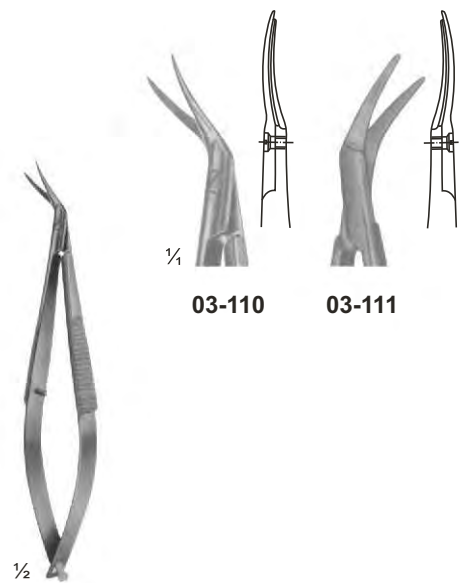

**03-110 - 111**  
CASTROVIEJO  
Eye Scissor  
Size: 110 mm

# Micro Scissors, "Spring Type" Flat Handles

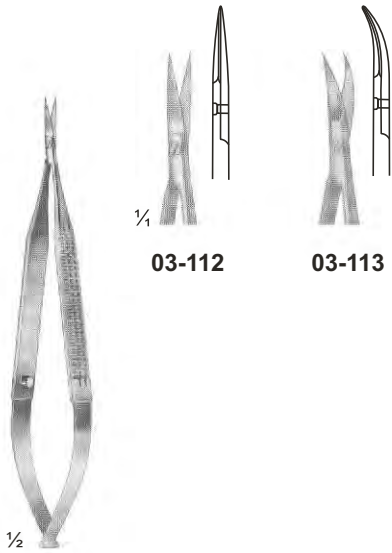

**03-112**  
Size: 120 mm

**03-113**

**03-112 - 113**  
Size: 120 mm



**03-114**  
BIEMER  
Vein Scissor  
Size: 130 mm

**03-115**  
Size: 160 mm

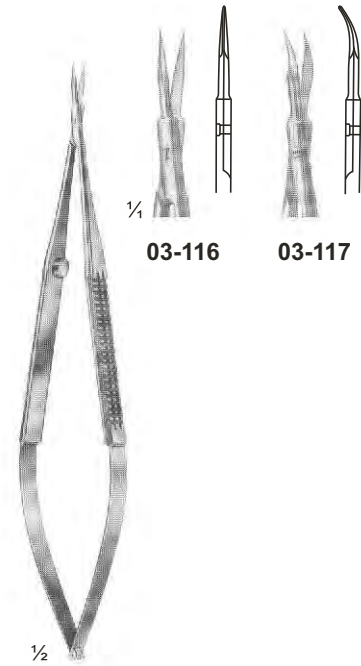

**03-116 - 117**  
VANNAS  
Size: 160 mm

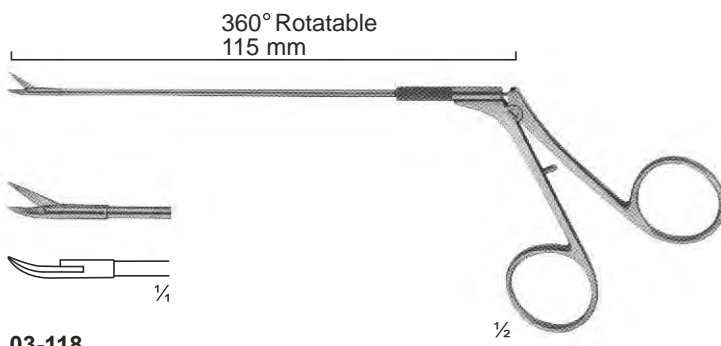

**03-118**  
CASPAR  
Micro Scissor Curved  
Size: 115 mm

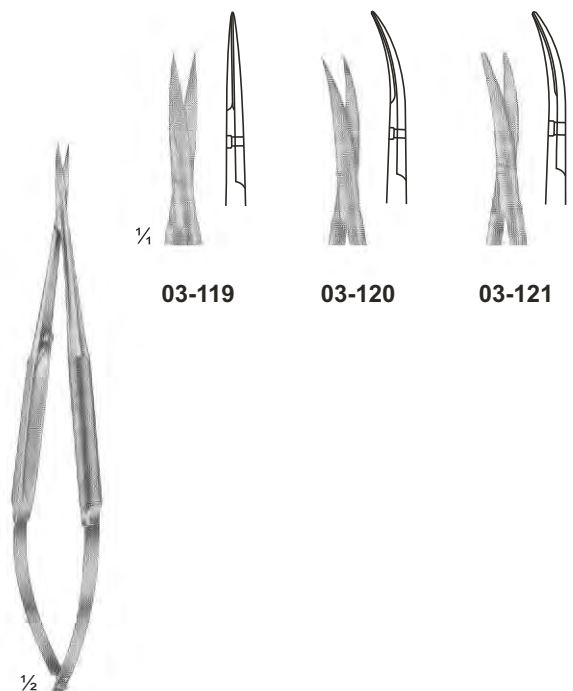

**03-119 - 121**  
Micro Dissecting Scissor  
Size: 145 mm

# Micro Scissors, "Spring Type" Bayonet Shape

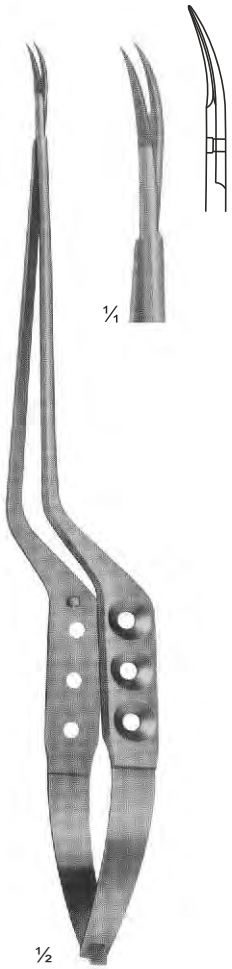

**03-122**  
YASARGIL  
Size: 245 mm

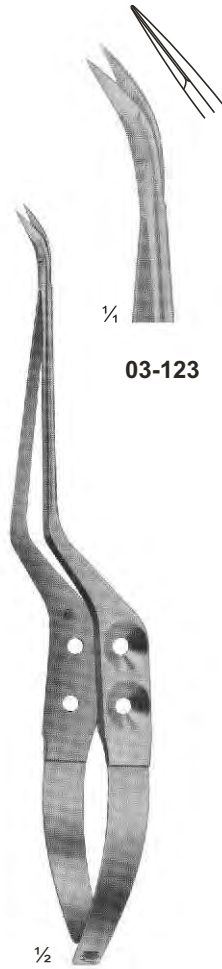

**03-123**



**03-124**

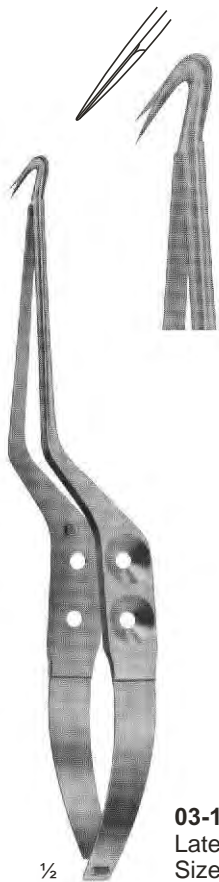

**03-125**  
Laterally Angled  
Size: 190 mm

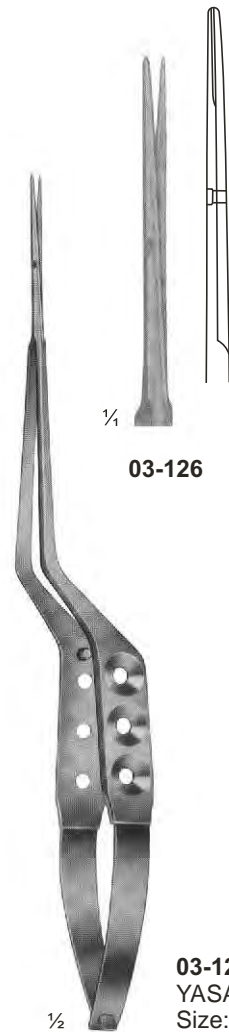

**03-126**

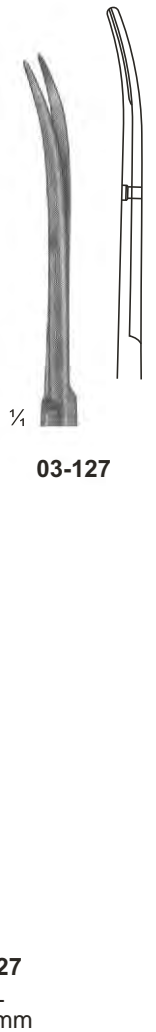

**03-127**

**03-126 - 127**  
YASARGIL  
Size: 225 mm

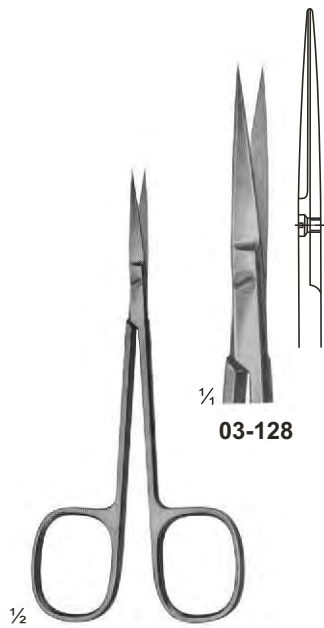

03-128

**03-128 - 129**  
Size: 120 mm



**03-129**

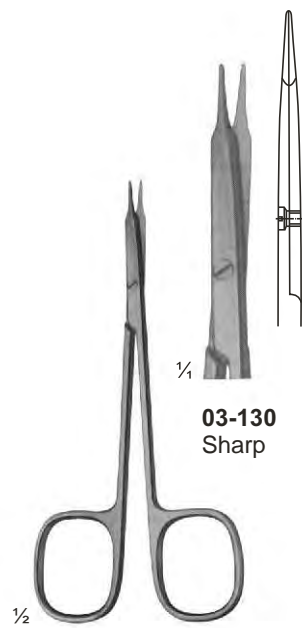

03-130  
Sharp

**03-130 - 133**  
STEVENS  
Dissecting Scissors  
Size: 115 mm

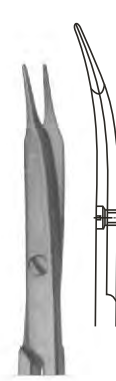

**03-131**  
Sharp



**03-132**  
Blunt



**03-133**  
Blunt

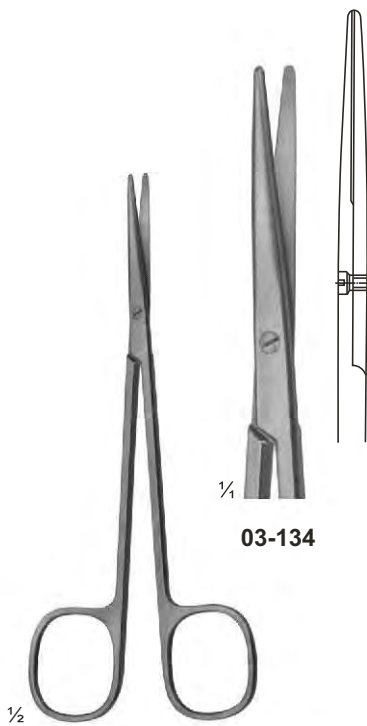

03-134

**03-134 - 135**  
METZENBAUM  
Dissecting Scissors  
Size: 145 mm

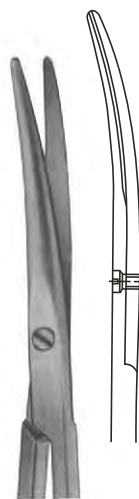

**03-135**

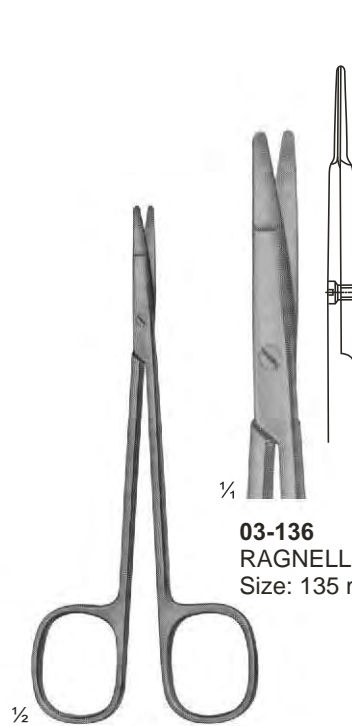

03-136  
RAGNELL  
Size: 135 mm

**03-136 - 138**  
Special flat points for  
dissecting and  
undermining the skin  
Size: 145 mm

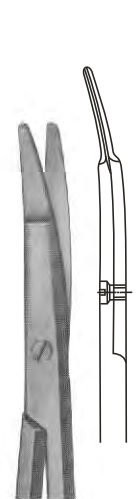

**03-137**  
RAGNELL  
Size: 135 mm

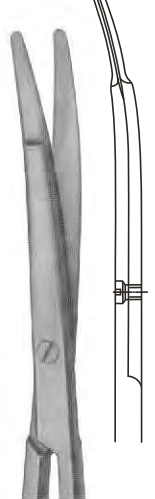

**03-138**  
Size: 150 mm

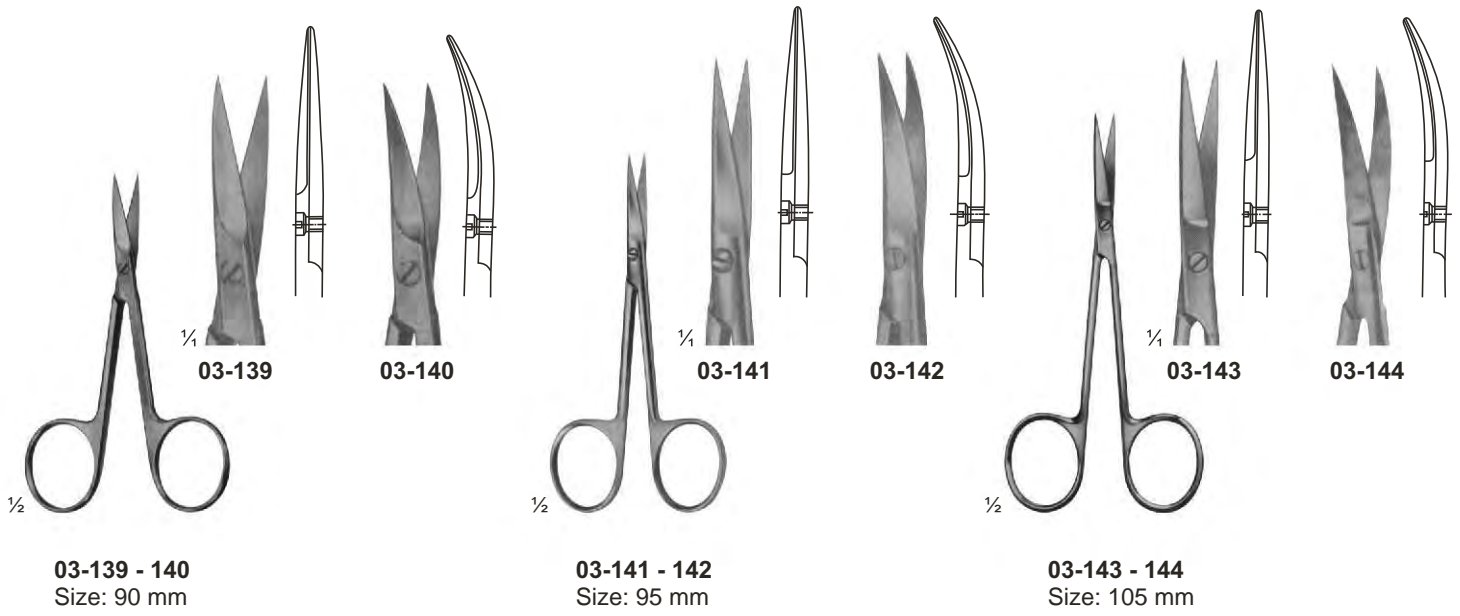



**03-149 - 151**  
Size: 120 mm

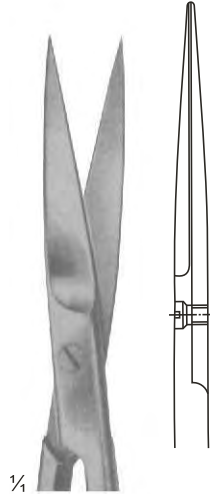

**03-149**

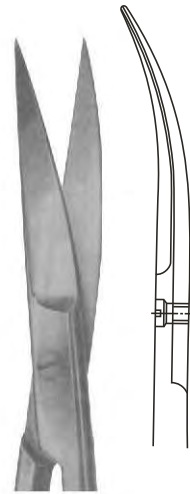

**03-150**

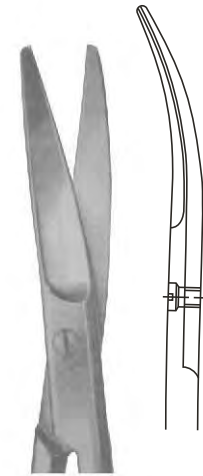

**03-151**



**03-152 - 155**  
Size: 130 mm

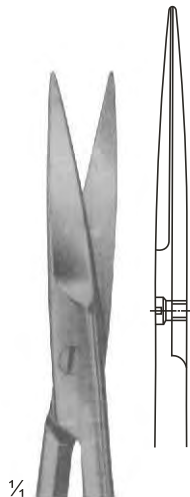

**03-152**

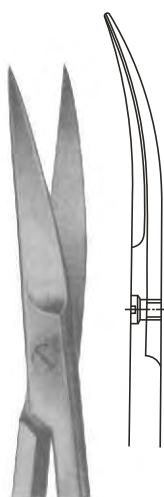

**03-153**

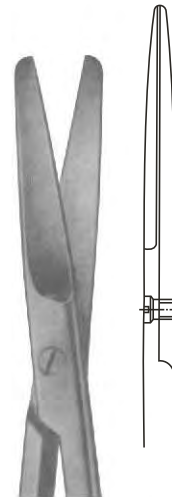

**03-154**

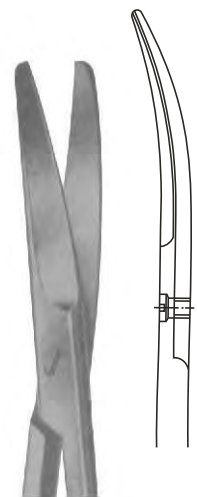

**03-155**

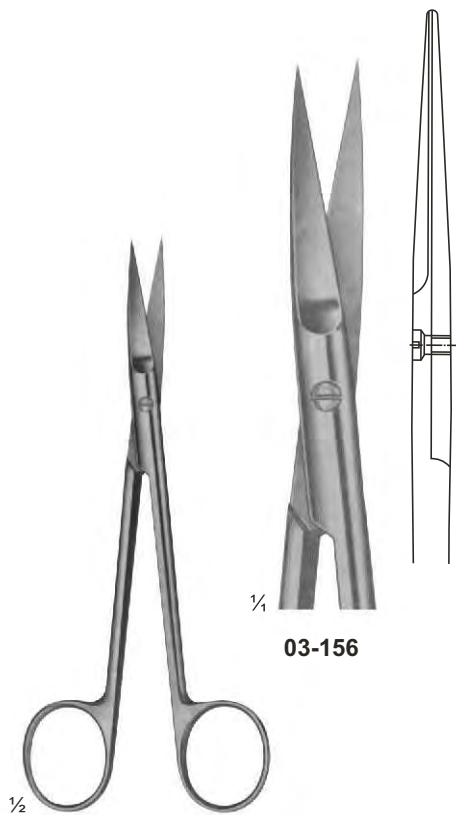

03-156

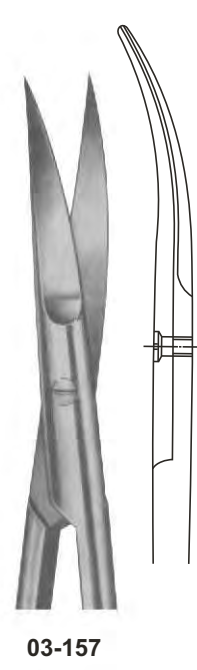

03-157

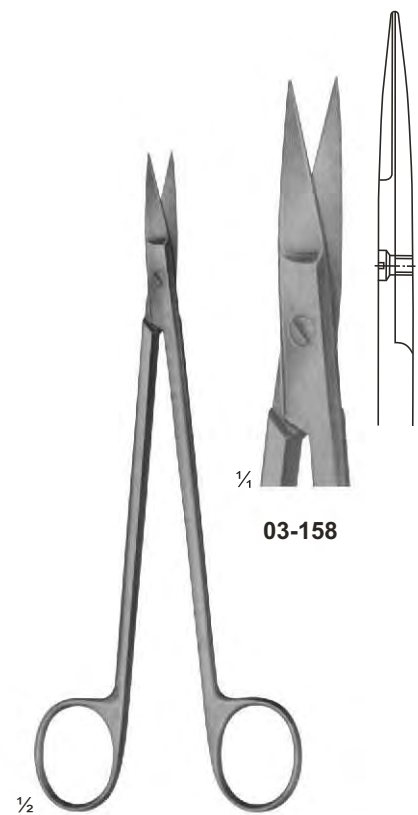

03-158

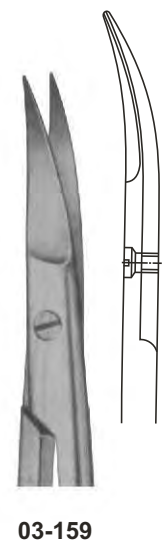

03-159

**03-156 - 157**  
JOSEPH  
Size: 150 mm

**03-158 - 159**  
KELLY  
Size: 175 mm

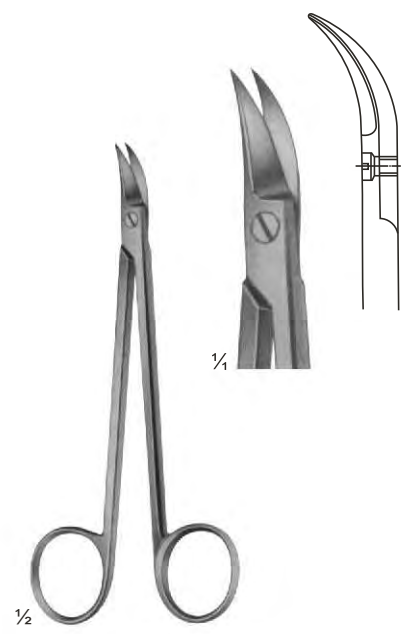

**03-160**  
QUINBY  
Size: 130 mm

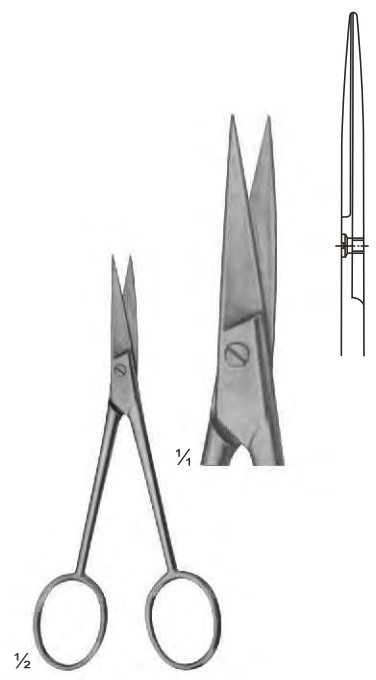

**03-161**  
Size: 110 mm

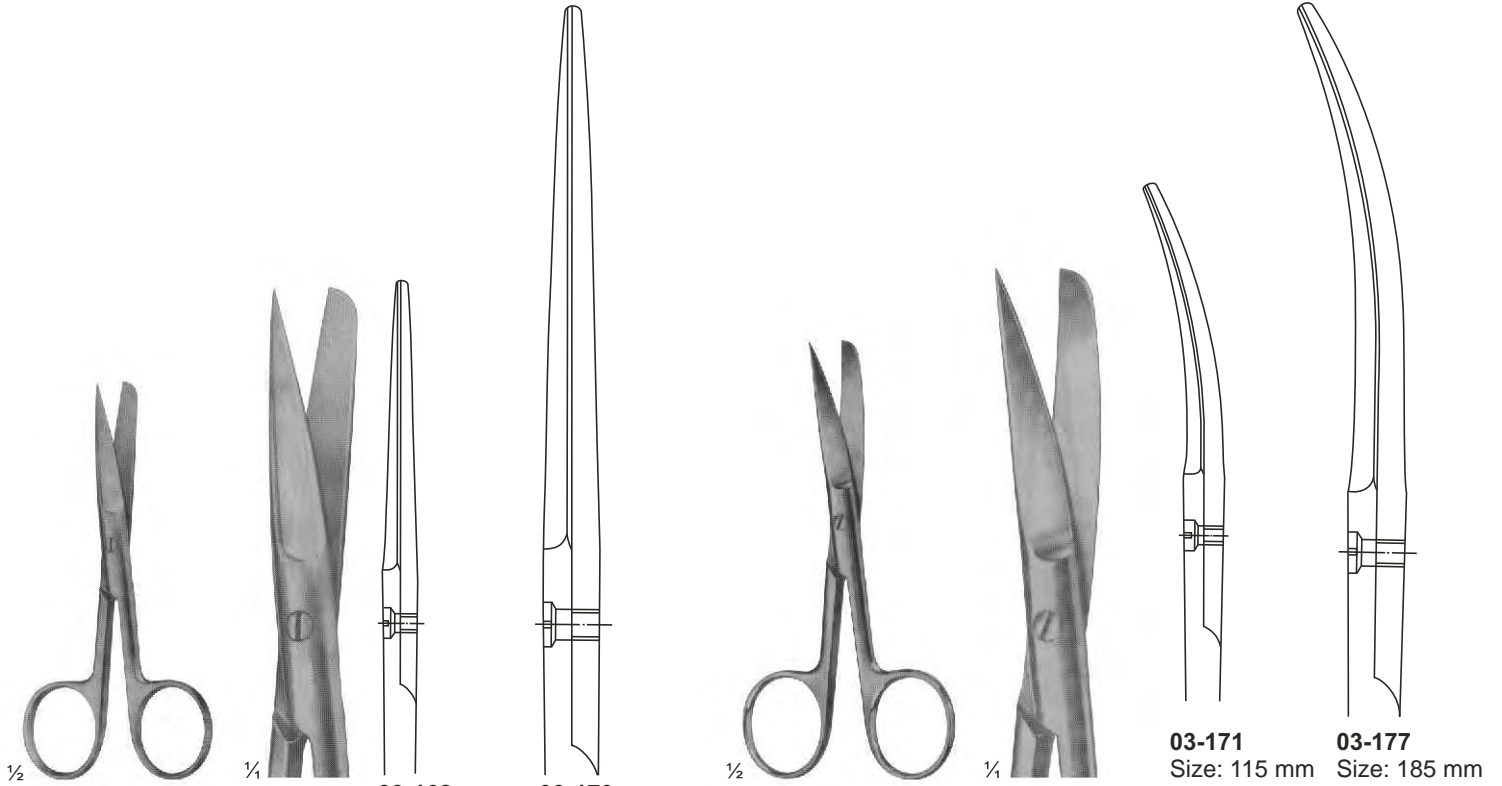

**03-162 - 170 (Standard Types)**  
**03-162** ( 105 mm )  
**03-163** ( 115 mm )  
**03-164** ( 130 mm )  
**03-165** ( 145 mm )  
**03-166** ( 150 mm )  
**03-167** ( 165 mm )  
**03-168** ( 175 mm )  
**03-169** ( 185 mm )  
**03-170** ( 200 mm )

**03-171 - 177 (Standard Types)**  
**03-171** ( 115 mm )  
**03-172** ( 130 mm )  
**03-173** ( 145 mm )  
**03-174** ( 150 mm )  
**03-175** ( 165 mm )  
**03-176** ( 175 mm )  
**03-177** ( 185 mm )

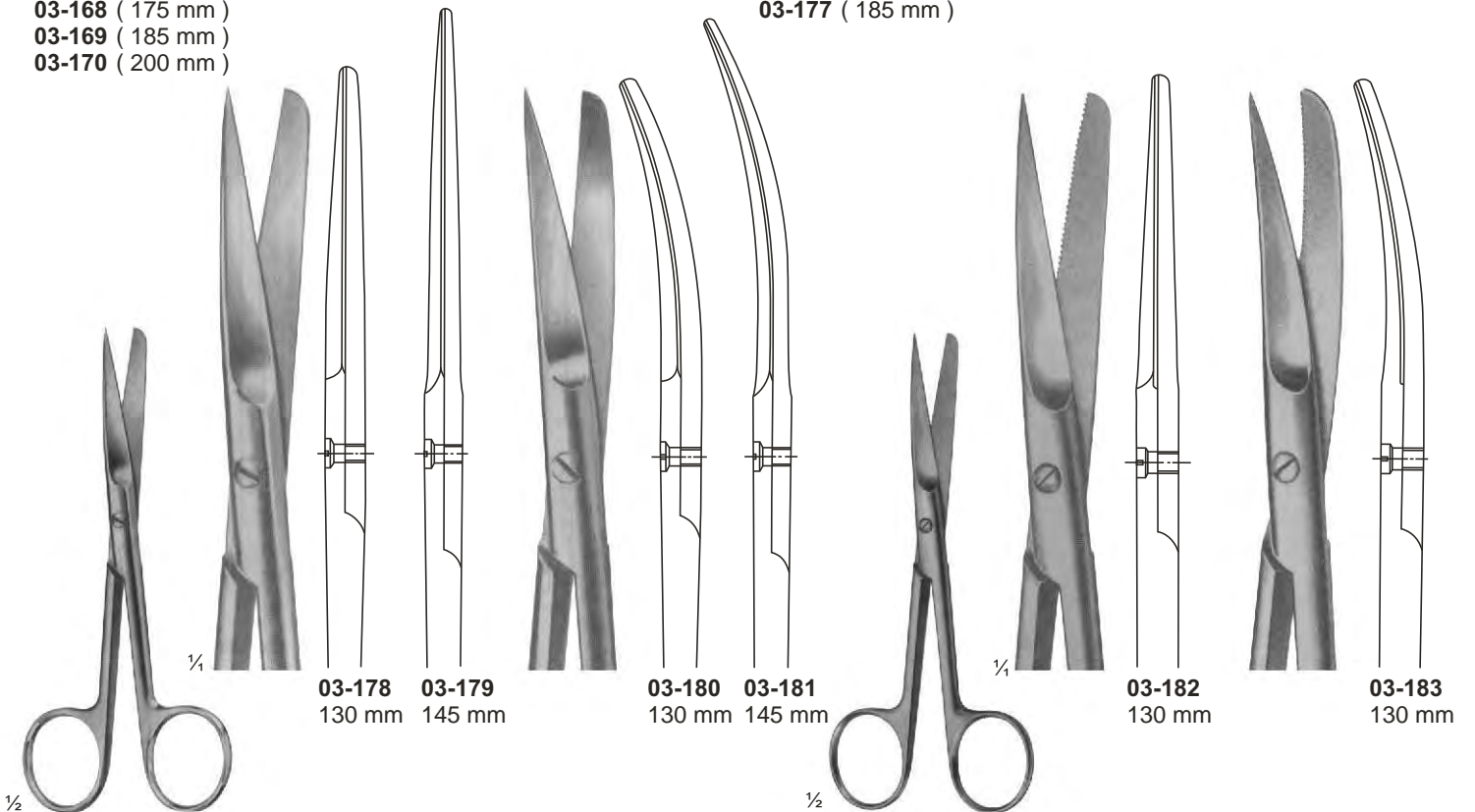

**03-178 - 181**  
 Slender Types

**03-182 - 183**  
 For Wound Edges  
 1 Blade Serrated

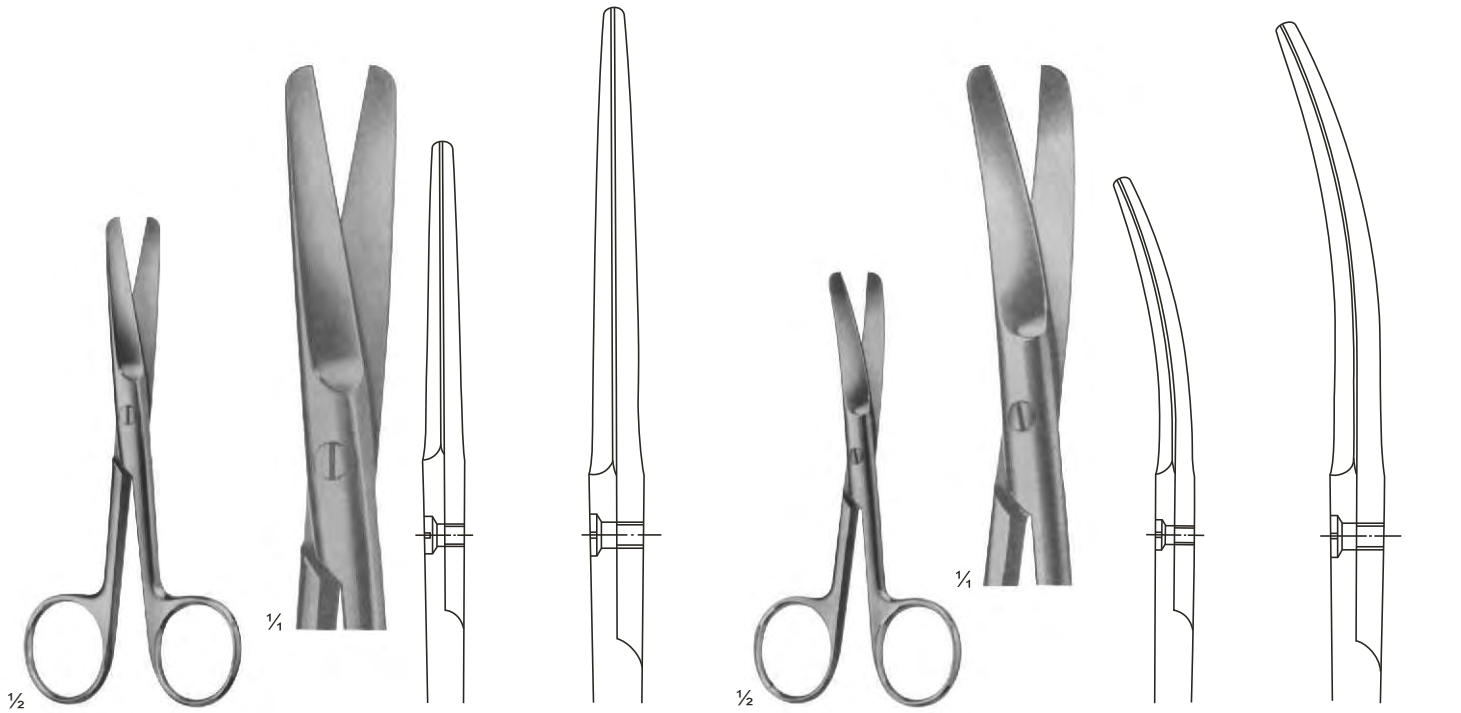

**03-184 - 188** (Standard Types)  
**03-184** ( 130 mm )  
**03-185** ( 145 mm )  
**03-186** ( 150 mm )  
**03-187** ( 165 mm )  
**03-188** ( 175 mm )

**03-184**      **03-188**  
 Size: 130 mm    Size: 175 mm

**03-189 - 194** - COOPER  
 Standard Types  
**03-189** ( 115 mm )  
**03-190** ( 130 mm )  
**03-191** ( 145 mm )  
**03-192** ( 150 mm )  
**03-193** ( 165 mm )  
**03-194** ( 175 mm )

**03-189**      **03-194**  
 Size: 115 mm    Size: 175 mm

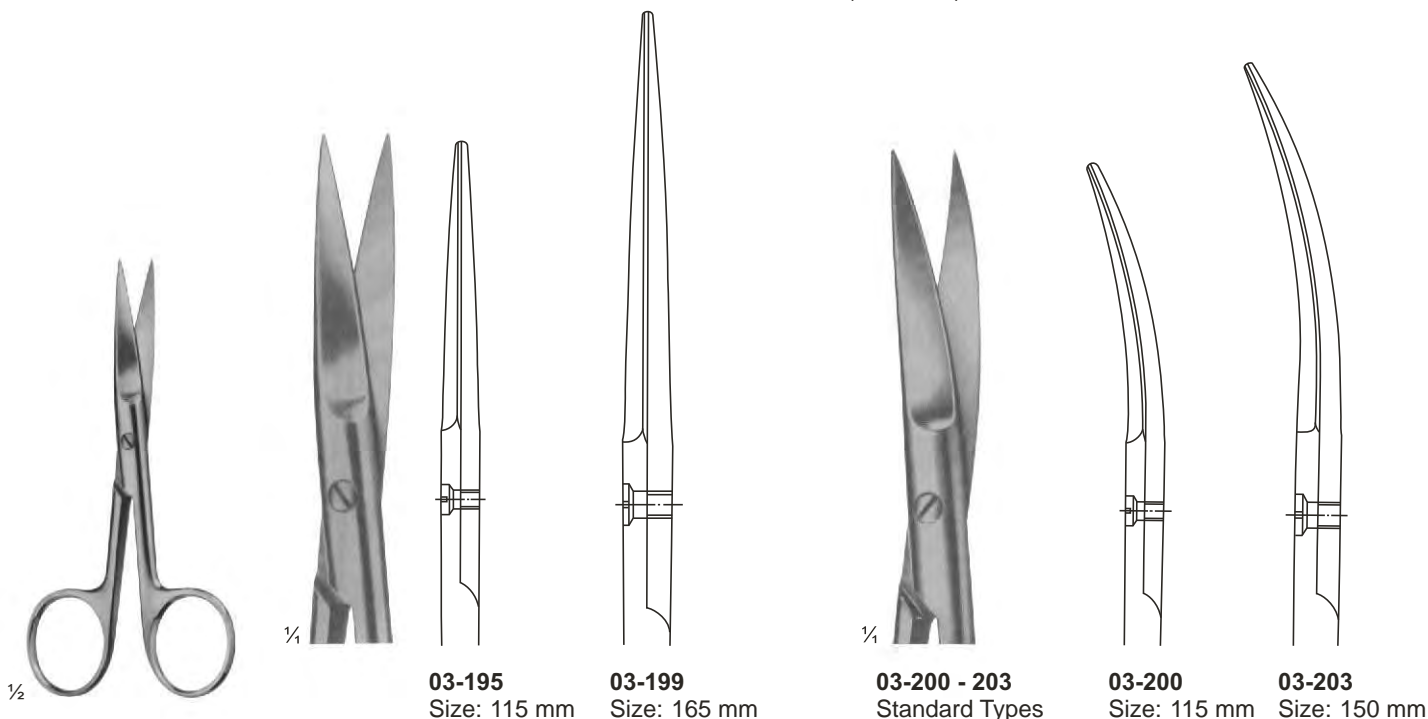

**03-195 - 199**  
 Standard Types  
**03-195** ( 115 mm )  
**03-196** ( 130 mm )  
**03-197** ( 145 mm )  
**03-198** ( 150 mm )  
**03-199** ( 165 mm )

**03-195**      **03-199**  
 Size: 115 mm    Size: 165 mm

**03-200 - 203**  
 Standard Types  
**03-200** ( 115 mm )  
**03-201** ( 130 mm )  
**03-202** ( 145 mm )  
**03-203** ( 150 mm )

**03-200**      **03-203**  
 Size: 115 mm    Size: 150 mm

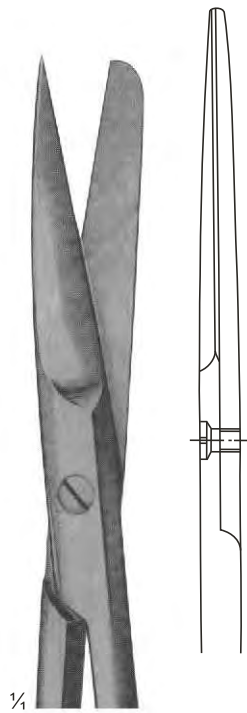
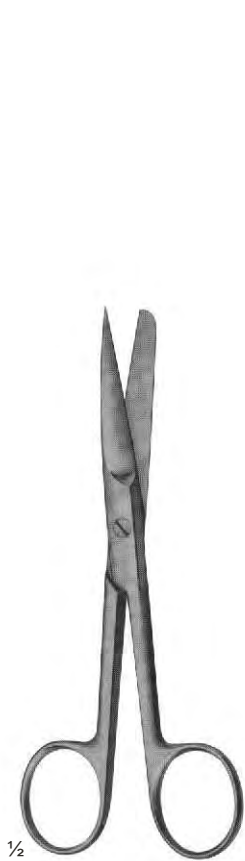

**03-204**  
Size: 145 mm

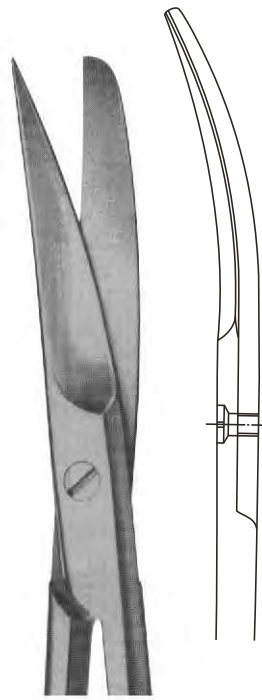

**03-205**  
Size: 145 mm

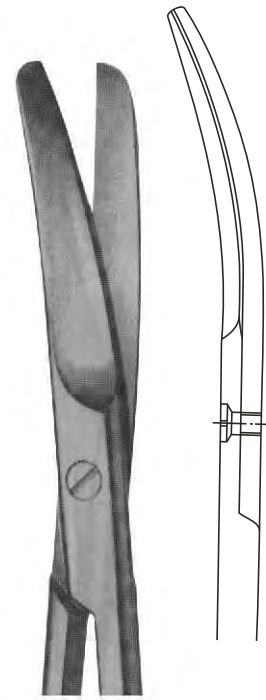

**03-206**  
Size: 145 mm

**03-204 - 206**  
DEAVER  
With flat lock

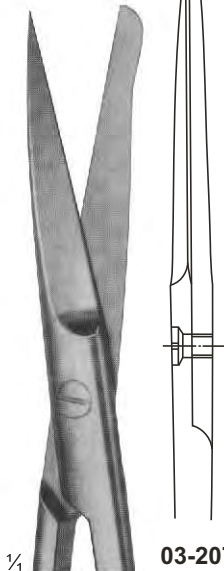

**03-207**  
Size: 130 mm

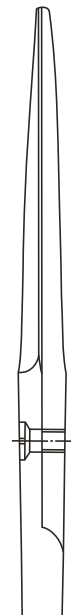

**03-208**  
Size: 145 mm

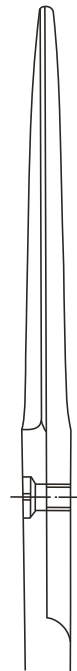

**03-209**  
Size: 165 mm

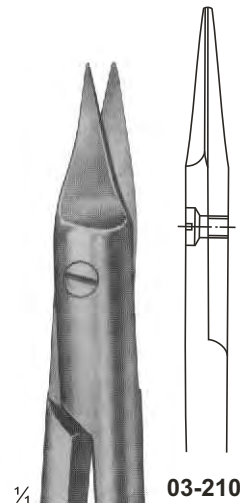
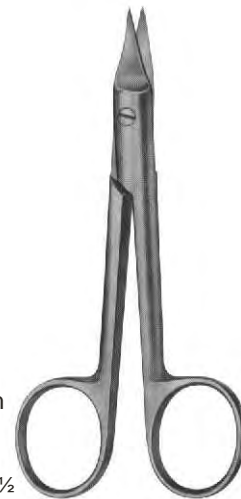

**03-210**  
Size: 130 mm

**03-207 - 209**  
Incision Scissors

**03-210**  
SYSTRUNK  
Nail Splitting Scissors

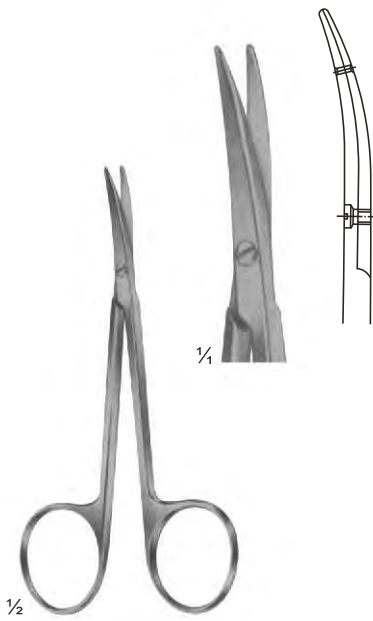

**03-211**  
LITTLER  
Dissecting Scissors  
Tips with eye for suture  
Size: 115 mm

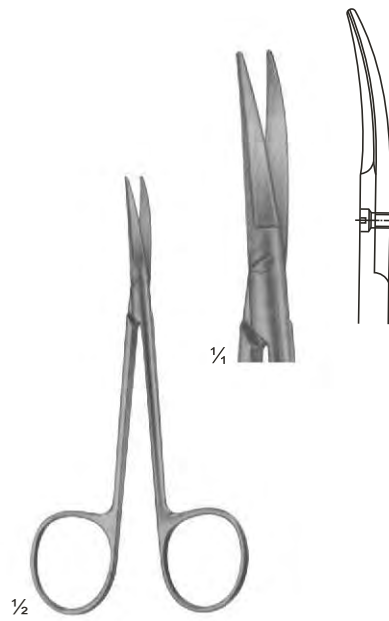

**03-212**  
COTTLE  
Bulldog Scissors  
Size: 115 mm

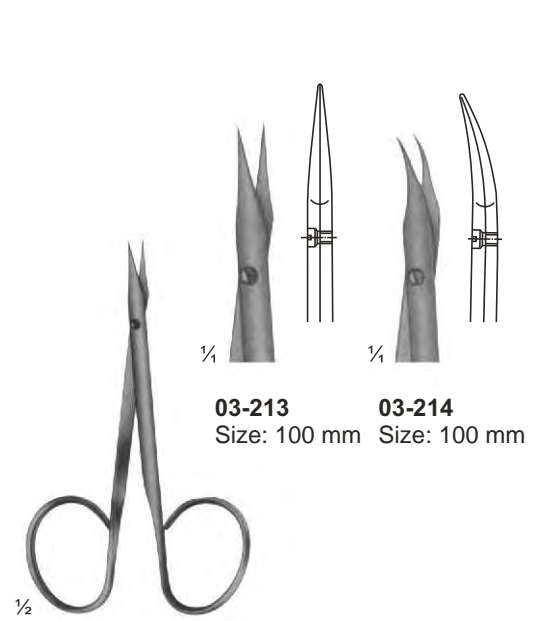

**03-213**      **03-214**  
Size: 100 mm    Size: 100 mm

**03-213 - 214**  
STEVENS  
Vessel and tendon Scissors  
Size: 100 mm

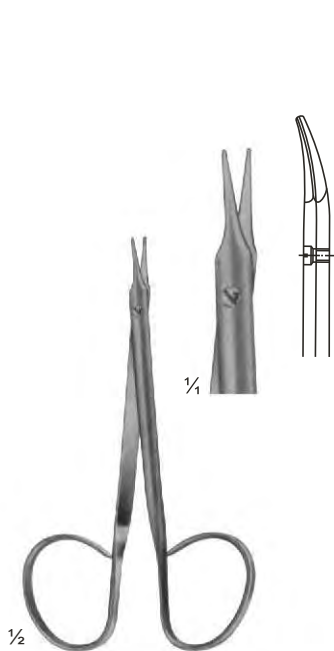

**03-215**  
STEVENS  
Fine Dissecting Scissors  
Size: 110 mm

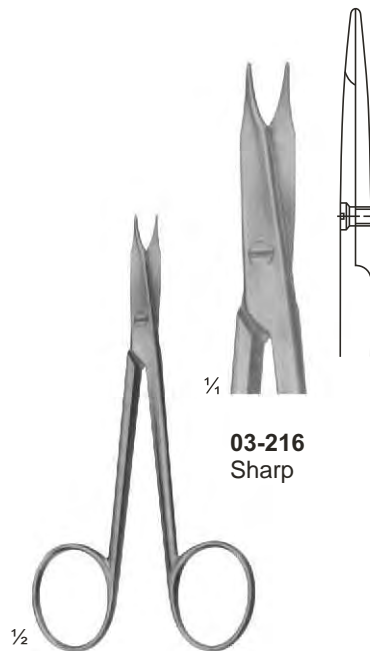

**03-216 - 219**  
STEVENS  
Vessel and tendon Scissors  
Size: 110 mm

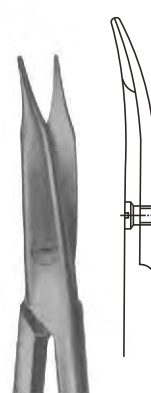

**03-217**  
Sharp

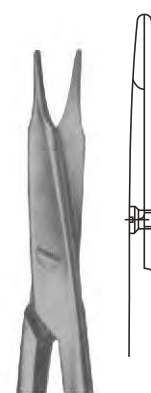

**03-218**  
Blunt

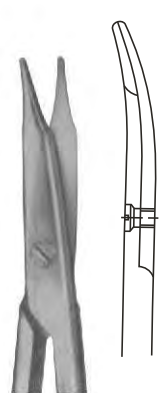

**03-219**  
Blunt

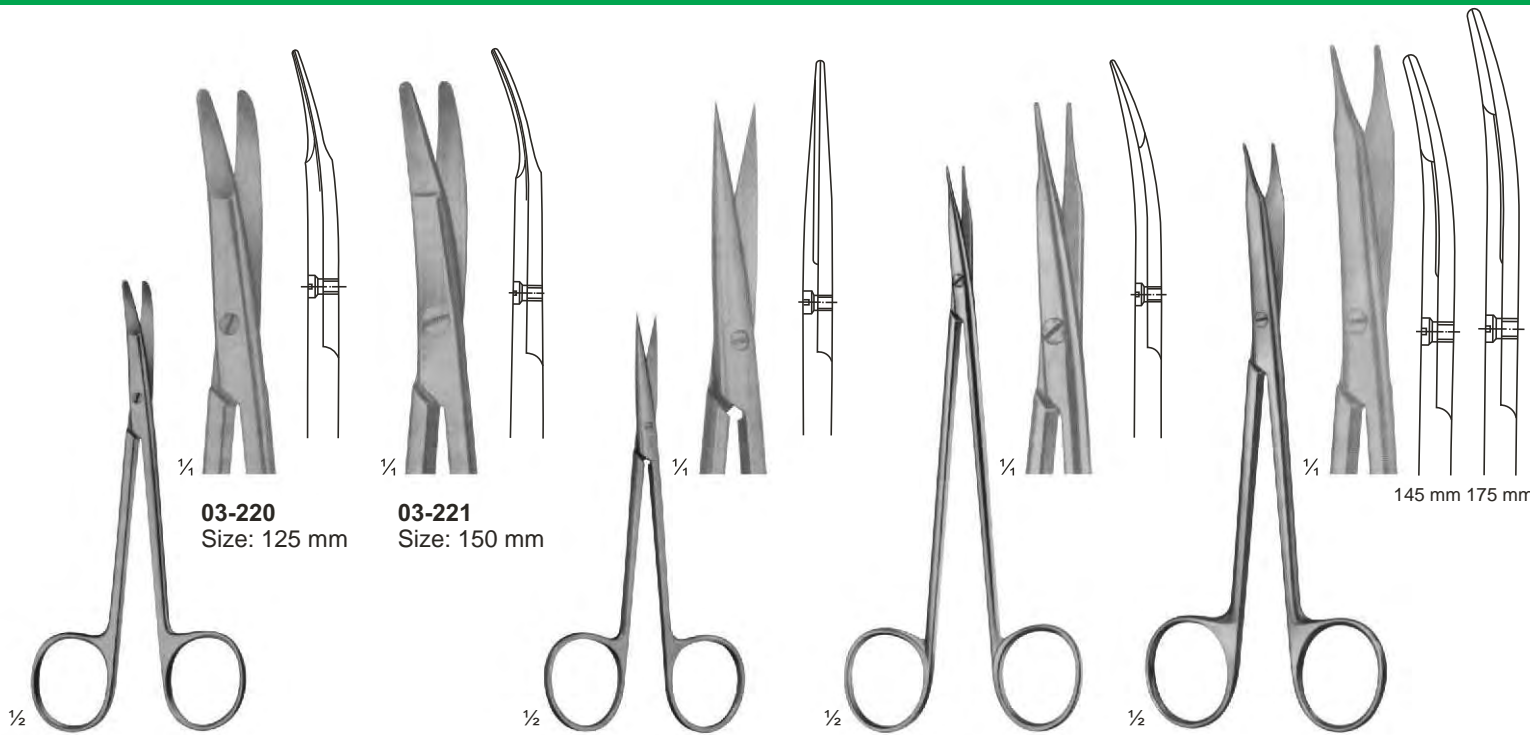

**03-220 - 221**  
**KILNER**  
 Special flat points for dissecting and undermining the skin

**03-222**  
**KILNER**  
 Fine dissecting scissors  
 Size: 115 mm

**03-223**  
**JAMESON**  
 Dissecting scissors  
 Size: 150 mm

**03-224**  
**REYNOLDS**  
 Dissecting scissors  
 Size: 145 - 175 mm

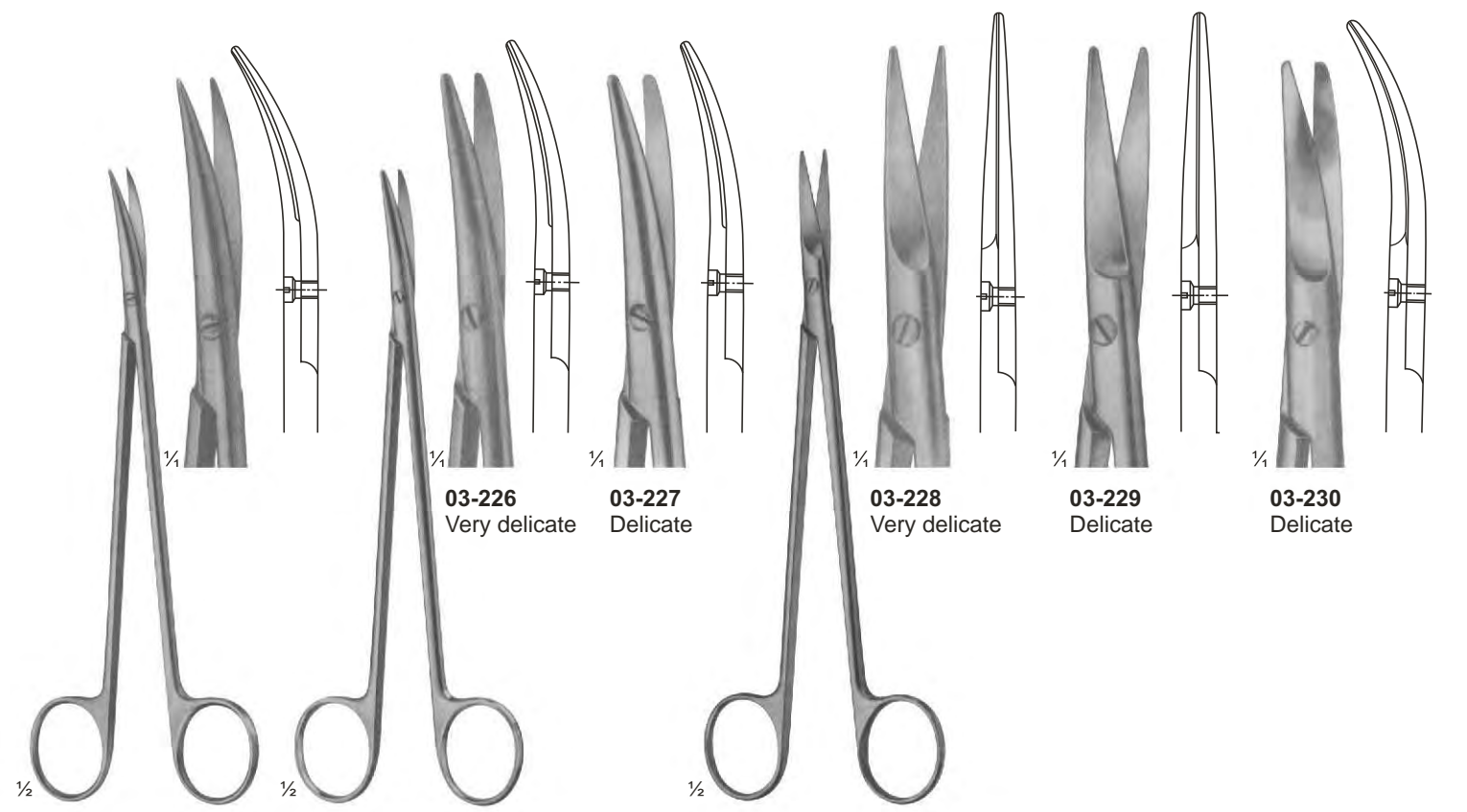

**03-225**  
**DE BAKEY**  
 Ateriotomy scissors  
 Size: 175 mm

**03-226 - 227**  
**TOENNIS ADSON**  
 Dissecting scissors  
 Size: 175 mm

**03-228 - 230**  
**TOENNIS**  
 Dissecting scissors  
 Size: 150 mm

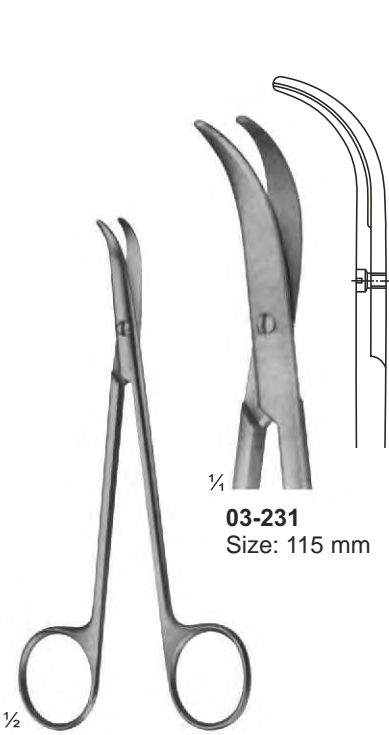

**03-231**  
Size: 115 mm

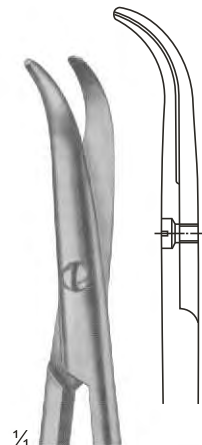

**03-232**  
Size: 135 mm

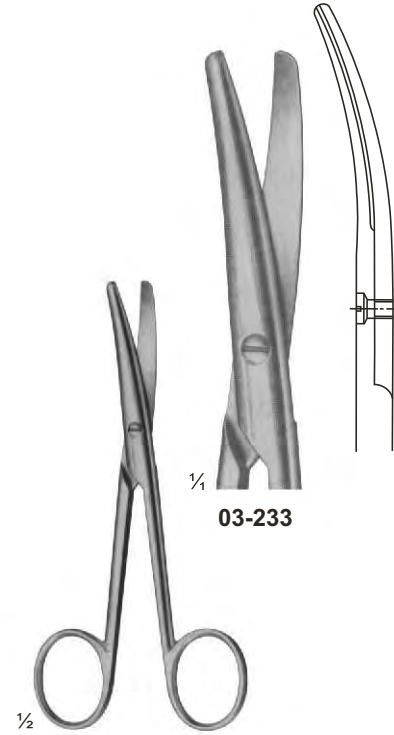

**03-233**

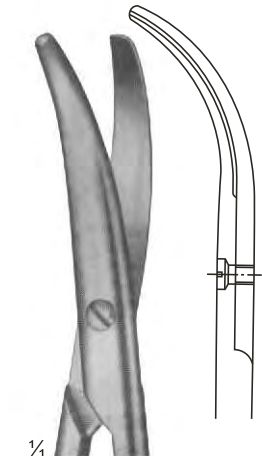

**03-234**

**03-231 - 232**  
FOMON  
Lower lateral scissors

**03-233 - 234**  
LANDOLT  
Enucleation scissors  
Size: 120 mm

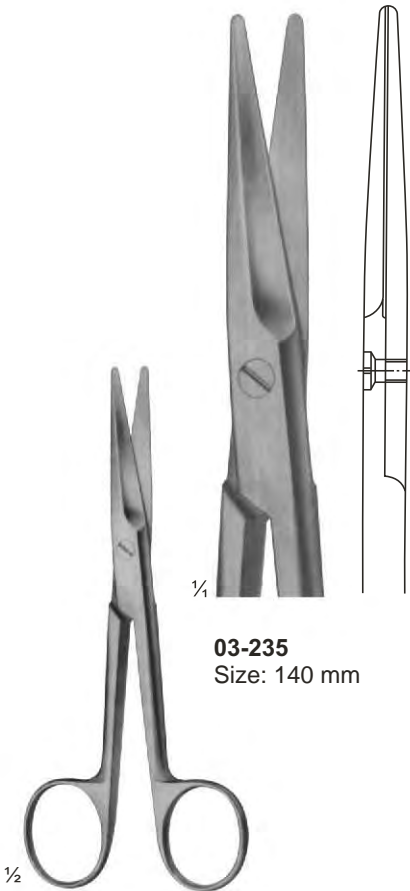

**03-235**  
Size: 140 mm

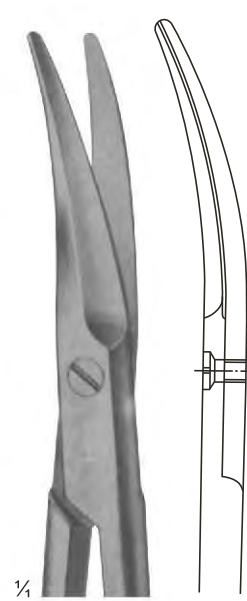

**03-238 - 240**  
MAYO  
03-238 (140 mm)  
03-239 (155 mm)  
03-240 (170 mm)

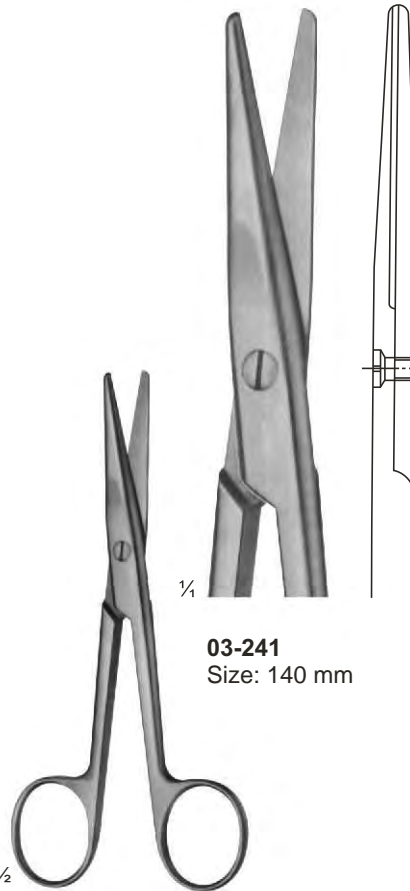

**03-241**  
Size: 140 mm

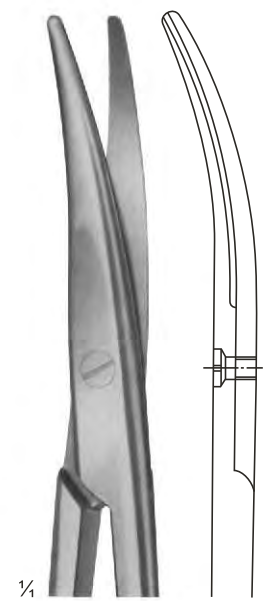

**03-243 - 244**  
MAYO-STILLE  
03-243 (140 mm)  
03-244 (170 mm)

**03-235 - 237**  
MAYO  
03-235 (140 mm)  
03-236 (155 mm)  
03-237 (170 mm)

**03-241 - 242**  
MAYO-STILLE  
03-241 (140 mm)  
03-242 (170 mm)

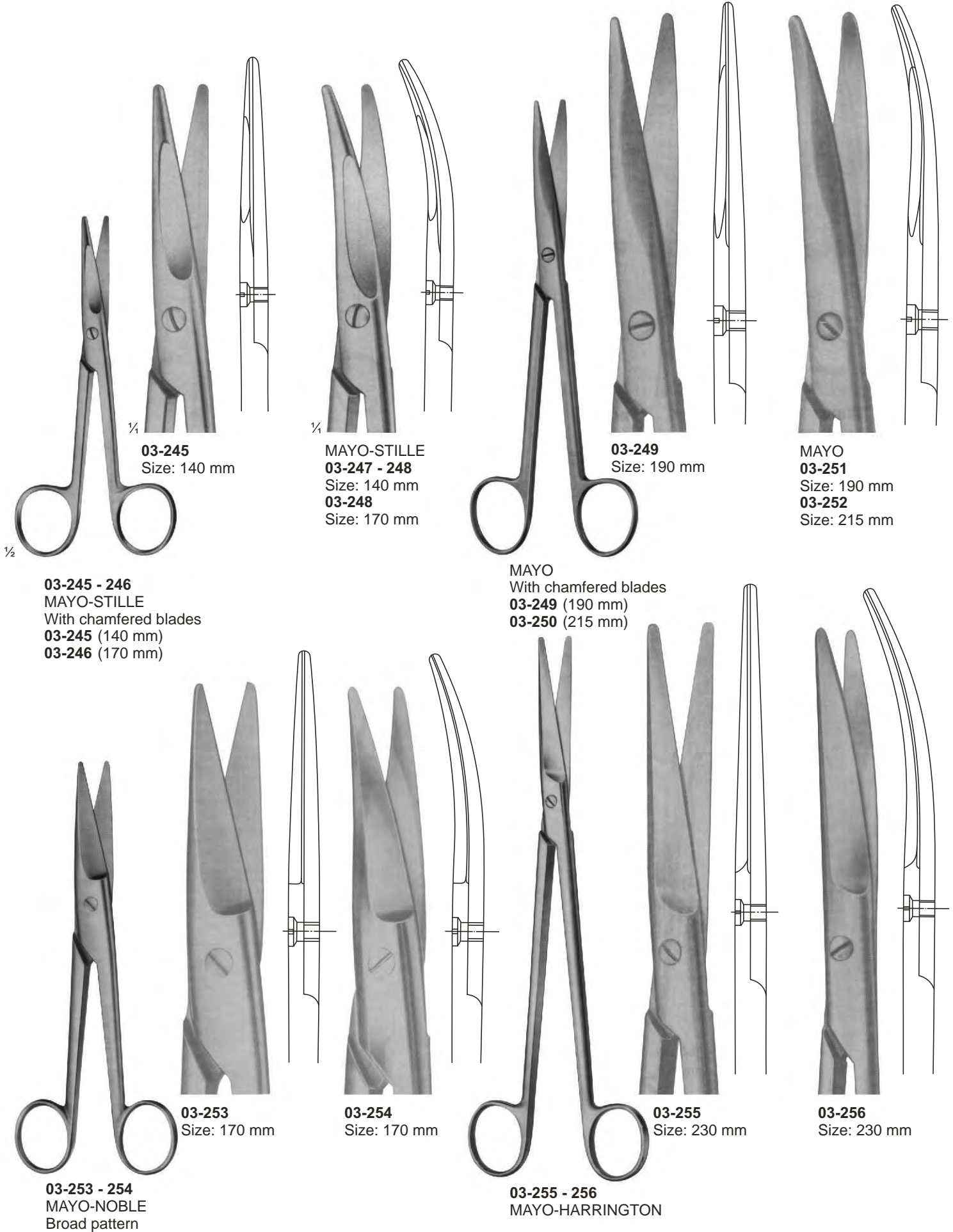

**03-245**  
Size: 140 mm

**MAYO-STILLE**  
**03-247 - 248**  
Size: 140 mm  
**03-248**  
Size: 170 mm

**03-249**  
Size: 190 mm

**MAYO**  
**03-251**  
Size: 190 mm  
**03-252**  
Size: 215 mm

**03-245 - 246**  
**MAYO-STILLE**  
With chamfered blades  
**03-245** (140 mm)  
**03-246** (170 mm)

**MAYO**  
With chamfered blades  
**03-249** (190 mm)  
**03-250** (215 mm)

**03-253**  
Size: 170 mm

**03-254**  
Size: 170 mm

**03-255**  
Size: 230 mm

**03-256**  
Size: 230 mm

**03-253 - 254**  
**MAYO-NOBLE**  
Broad pattern

**03-255 - 256**  
**MAYO-HARRINGTON**

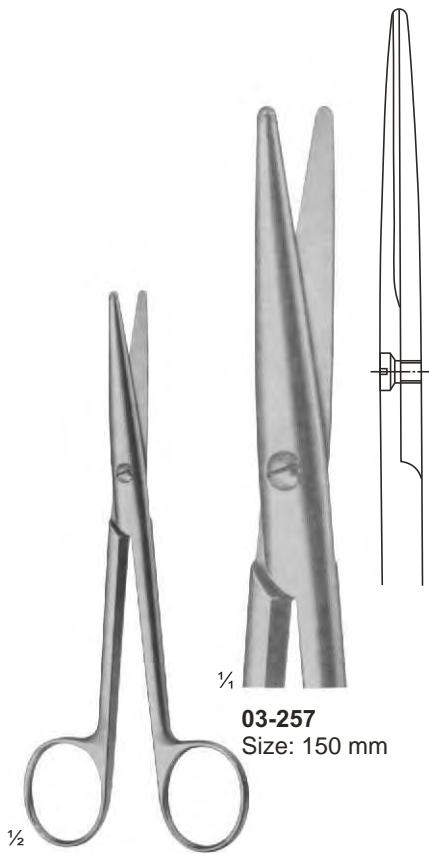

**03-257**  
Size: 150 mm

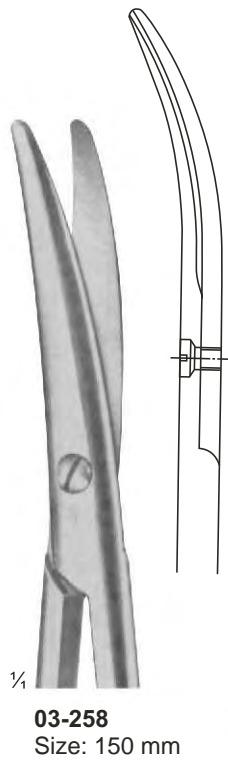

**03-258**  
Size: 150 mm

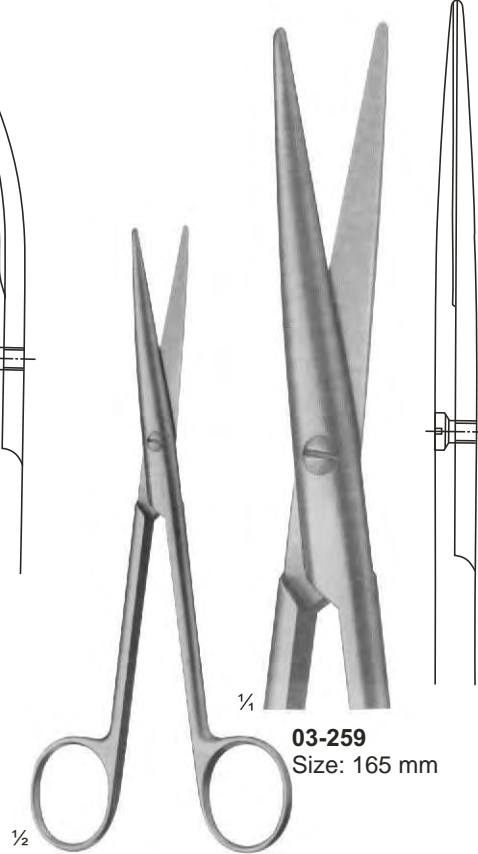

**03-259**  
Size: 165 mm

**03-260**  
Size: 165 mm

**03-257 - 258**  
STILLE  
Size: 150 mm

**03-259 - 260**  
LEXER  
Narrow  
Size: 165 mm

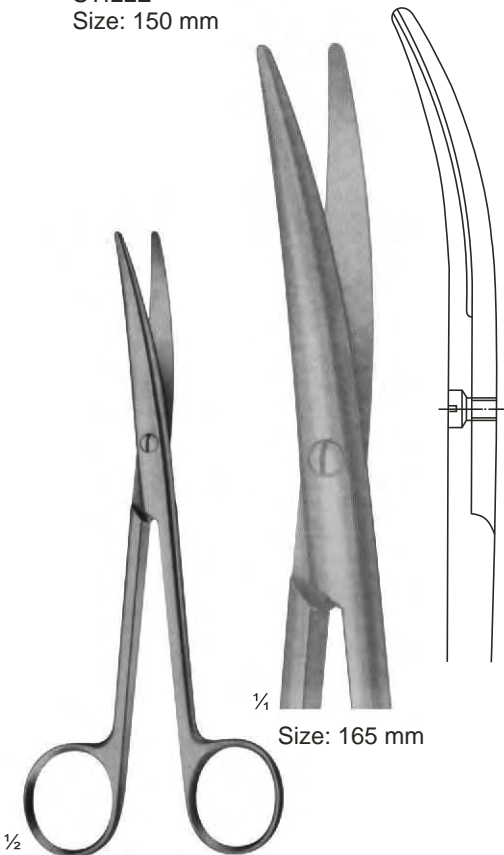

Size: 165 mm

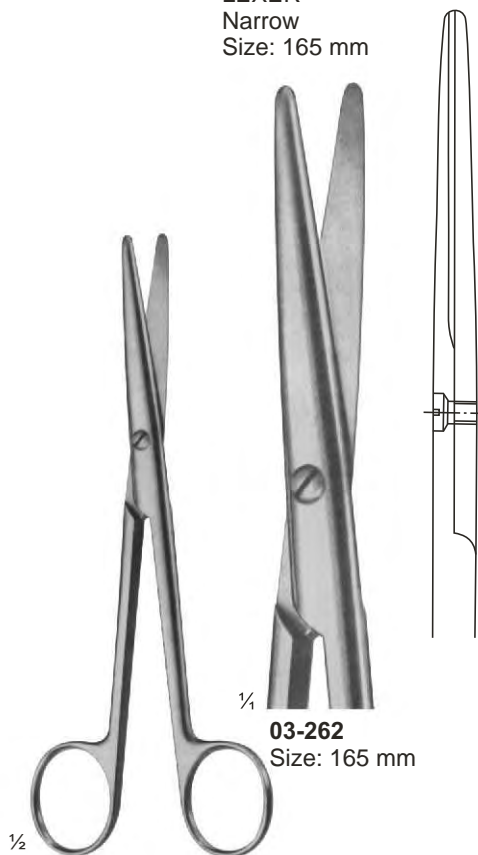

**03-262**  
Size: 165 mm

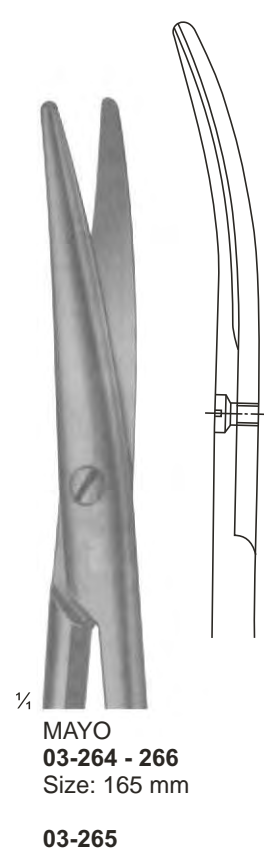

**MAYO**  
**03-264 - 266**  
Size: 165 mm

**03-261**  
MAYO-LEXER  
Standard

**03-262 - 263**  
MAYO  
**03-262** (165 mm)  
**03-263** (200 mm)

**03-265**  
Size: 200 mm  
**03-266**  
Size: 210 mm

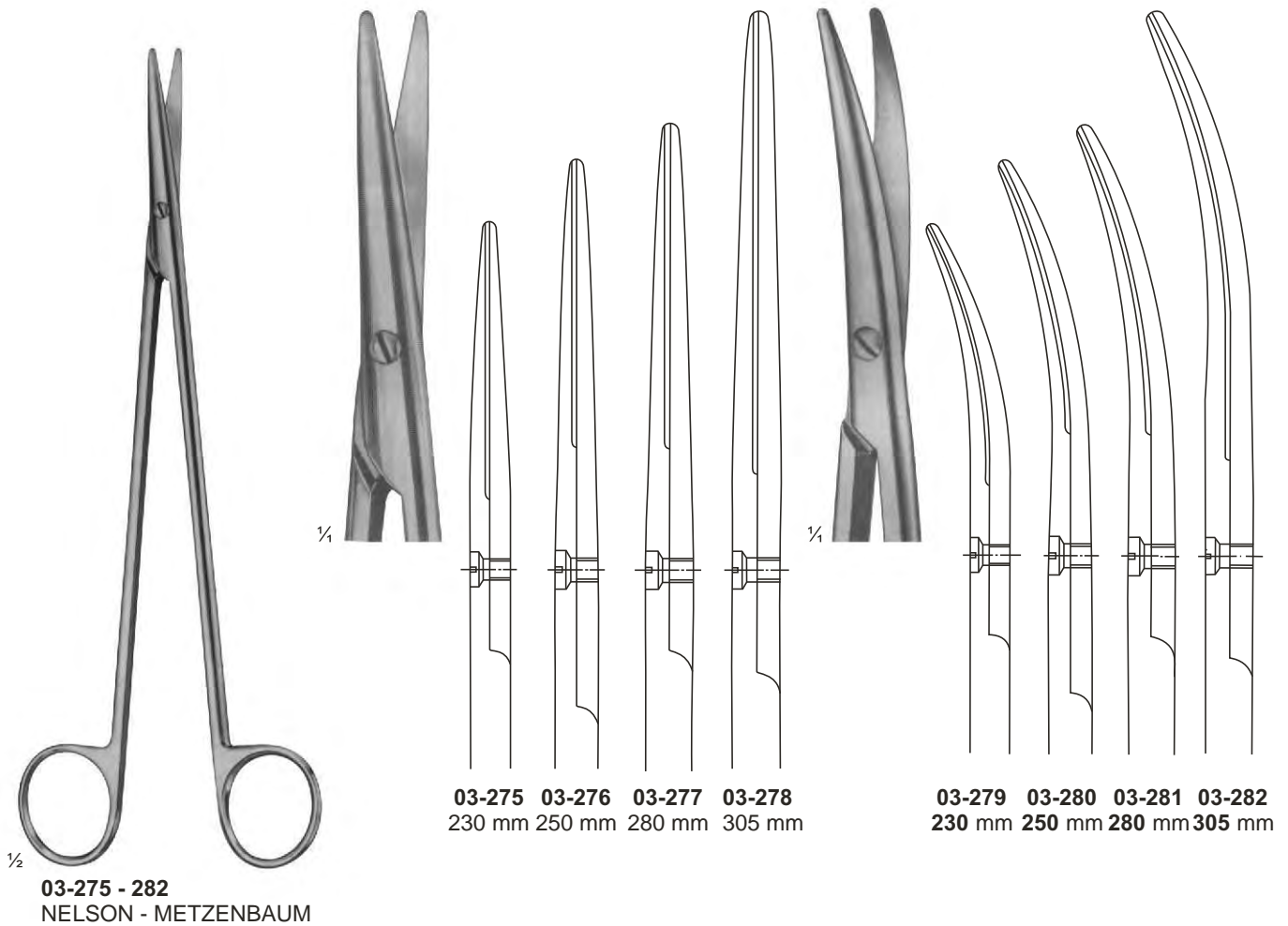
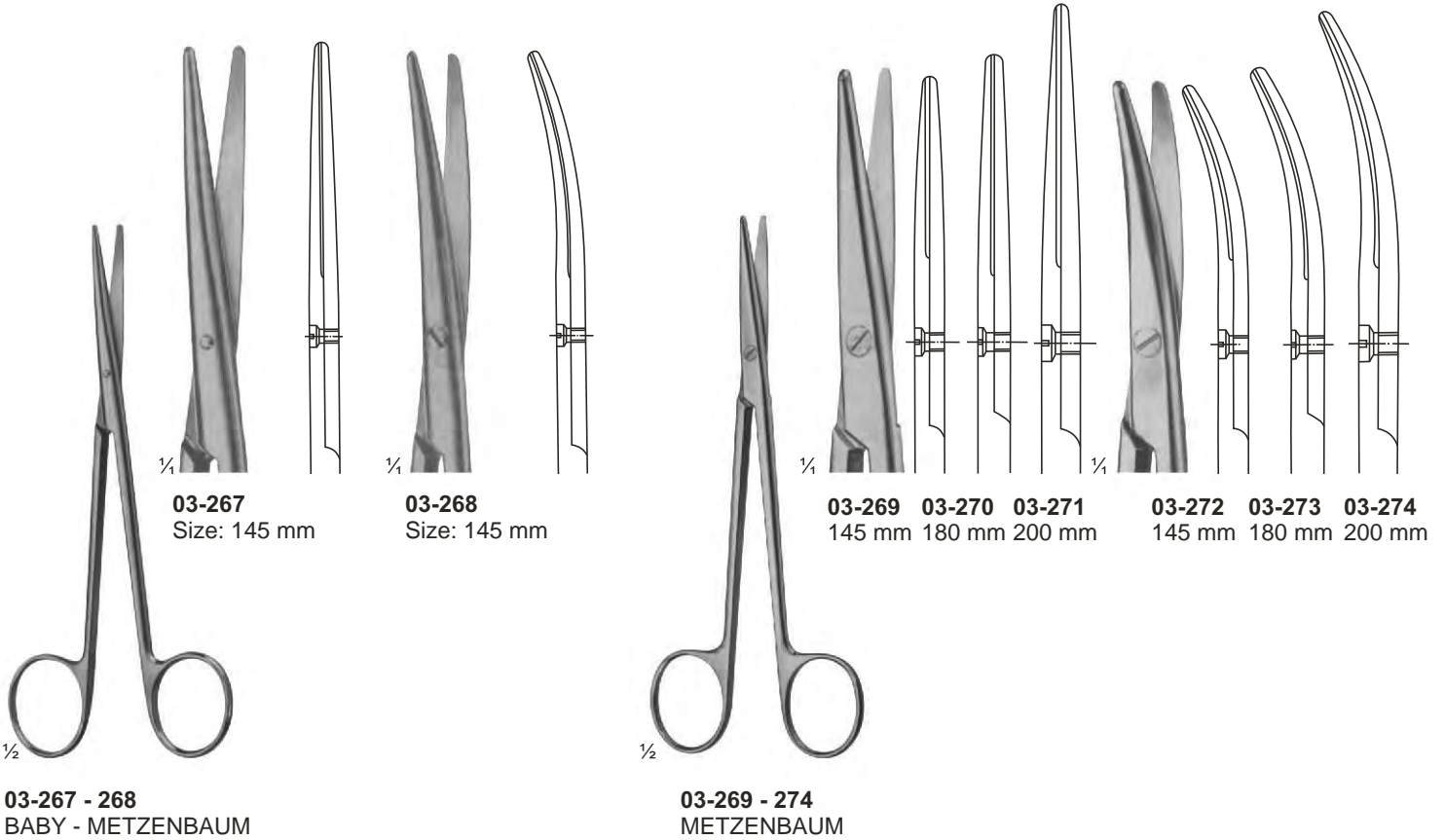

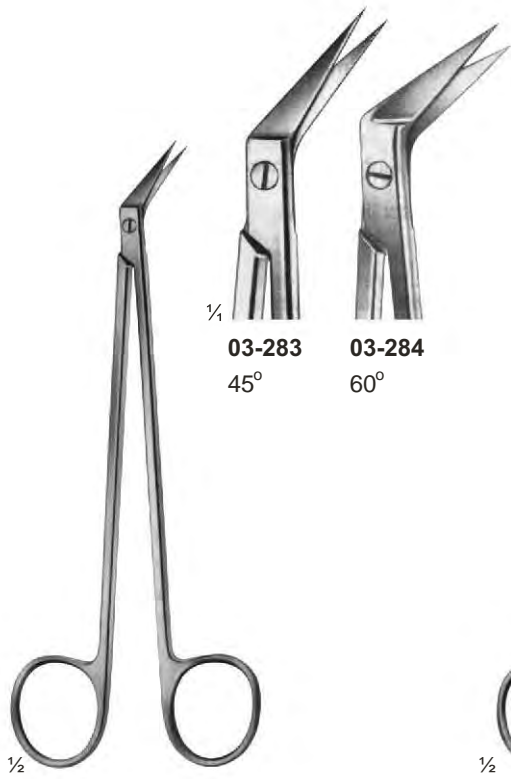

**03-283**  
45°

**03-284**  
60°

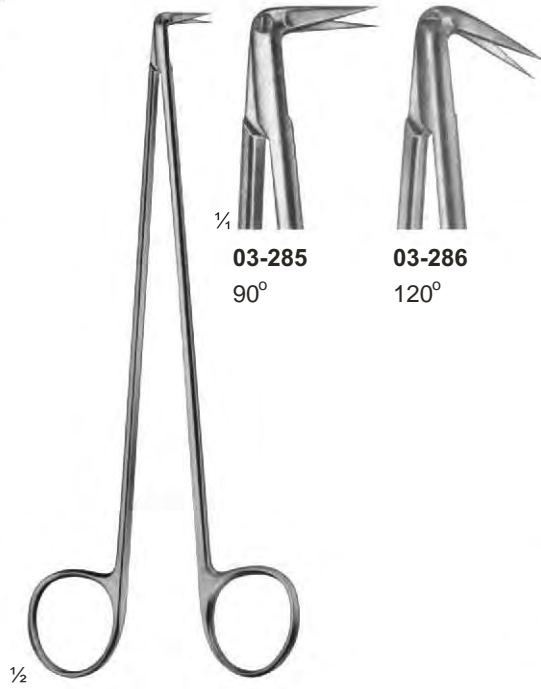

**03-285**  
90°

**03-286**  
120°

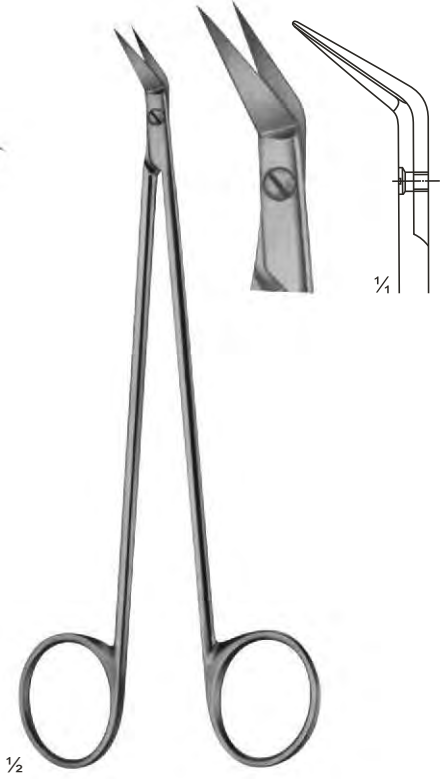

**03-287**  
POTTS-SMITH  
Size: 180 mm

**03-283 - 284**  
DE BAKKEY  
Size: 155 mm

**03-285 - 286**  
DIETRICH  
Size: 170 mm

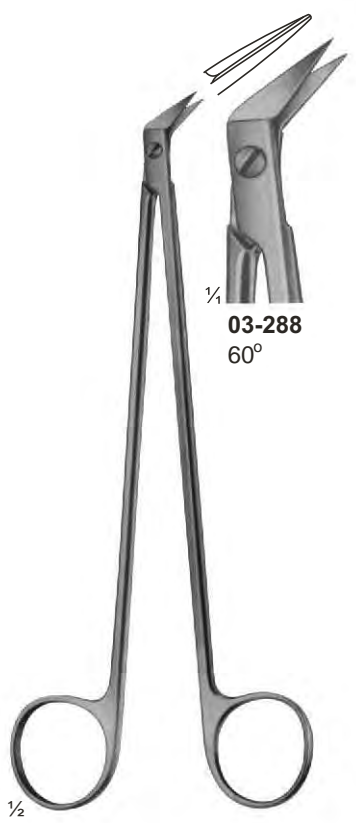

**03-288**  
60°

**03-288**  
POTTS-SMITH  
Size: 180 mm

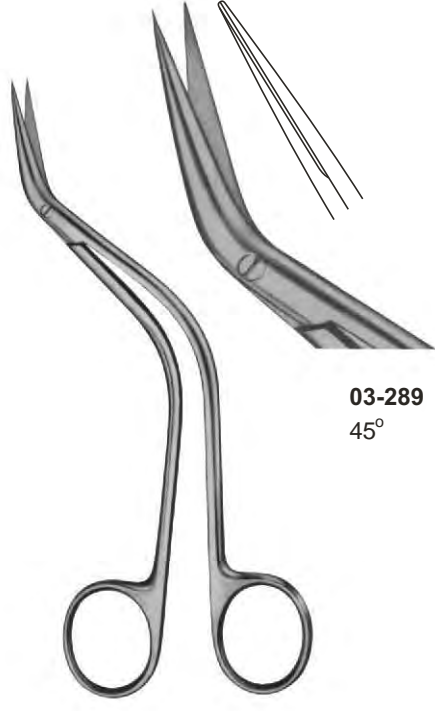

**03-289**  
45°

**03-289**  
DEBAKEY  
Size: 155 mm



**03-290**  
55°

**03-290**  
FAVOLORO  
Size: 140 mm



**03-291**  
OLIVECRONA  
Dura Scissors

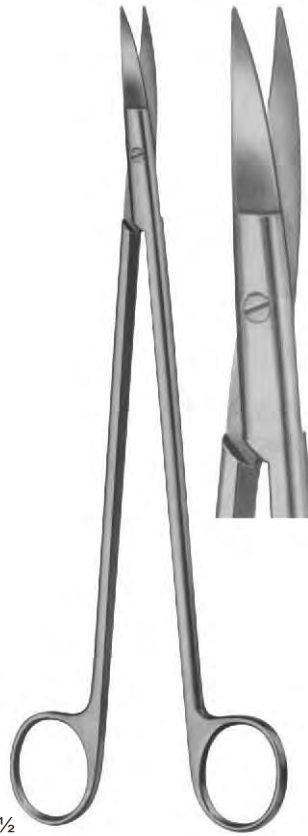

**03-292**  
STRULLY  
Pointed  
Size: 220 mm

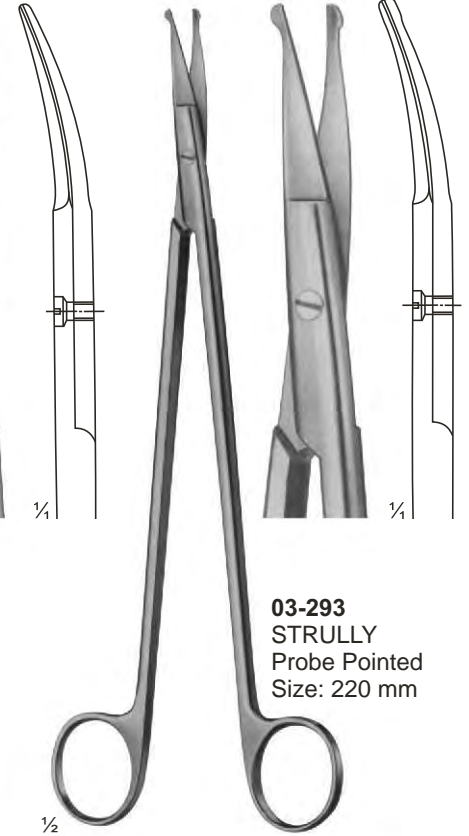

**03-293**  
STRULLY  
Probe Pointed  
Size: 220 mm

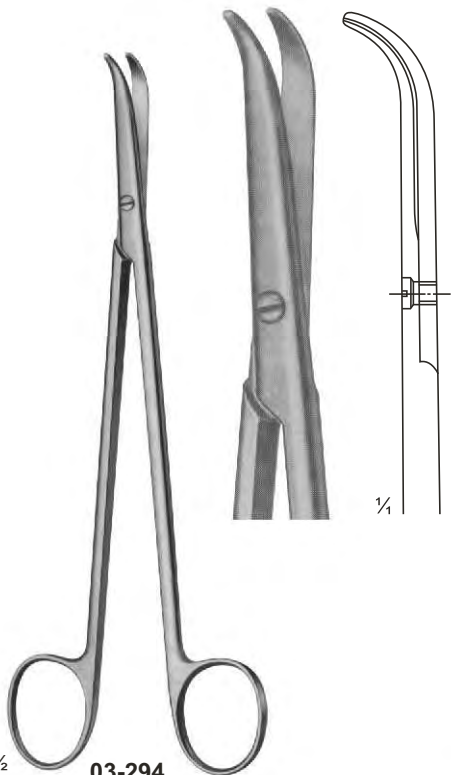

**03-294**  
THOREK  
Size: 180 mm

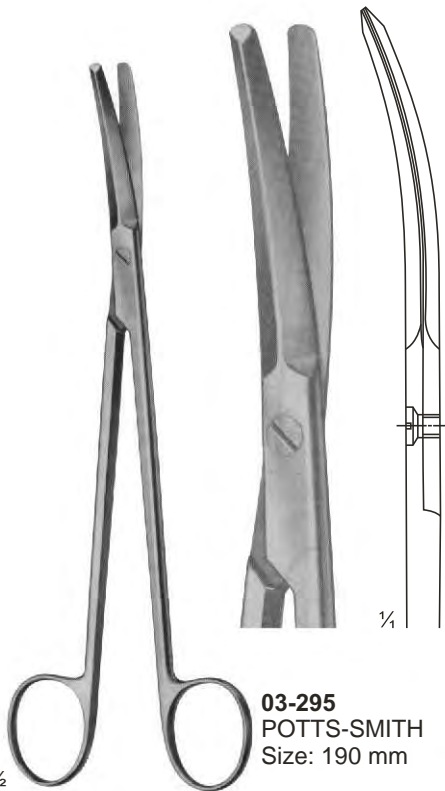

**03-295**  
POTTS-SMITH  
Size: 190 mm

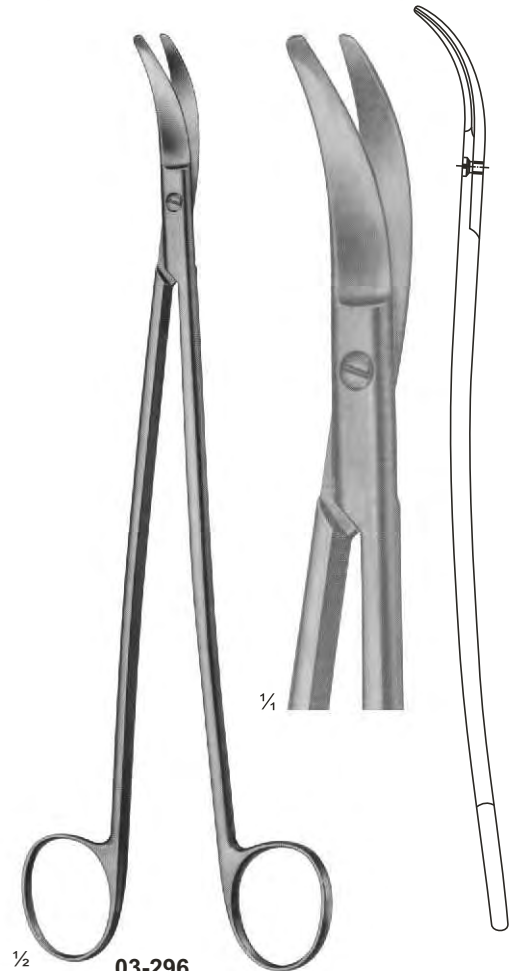

**03-296**  
SATINSKY  
Size: 245 mm



**03-297**  
1 Finely Toothed Blade  
Size: 130 mm

**03-298**  
LOCKLIN  
Curved Sideways,  
1 Toothed Blade  
Size: 155 mm

**03-299**  
FOMON  
Blades Serrated  
Size: 145 mm

**03-300**  
COTTLE  
Size: 165 mm

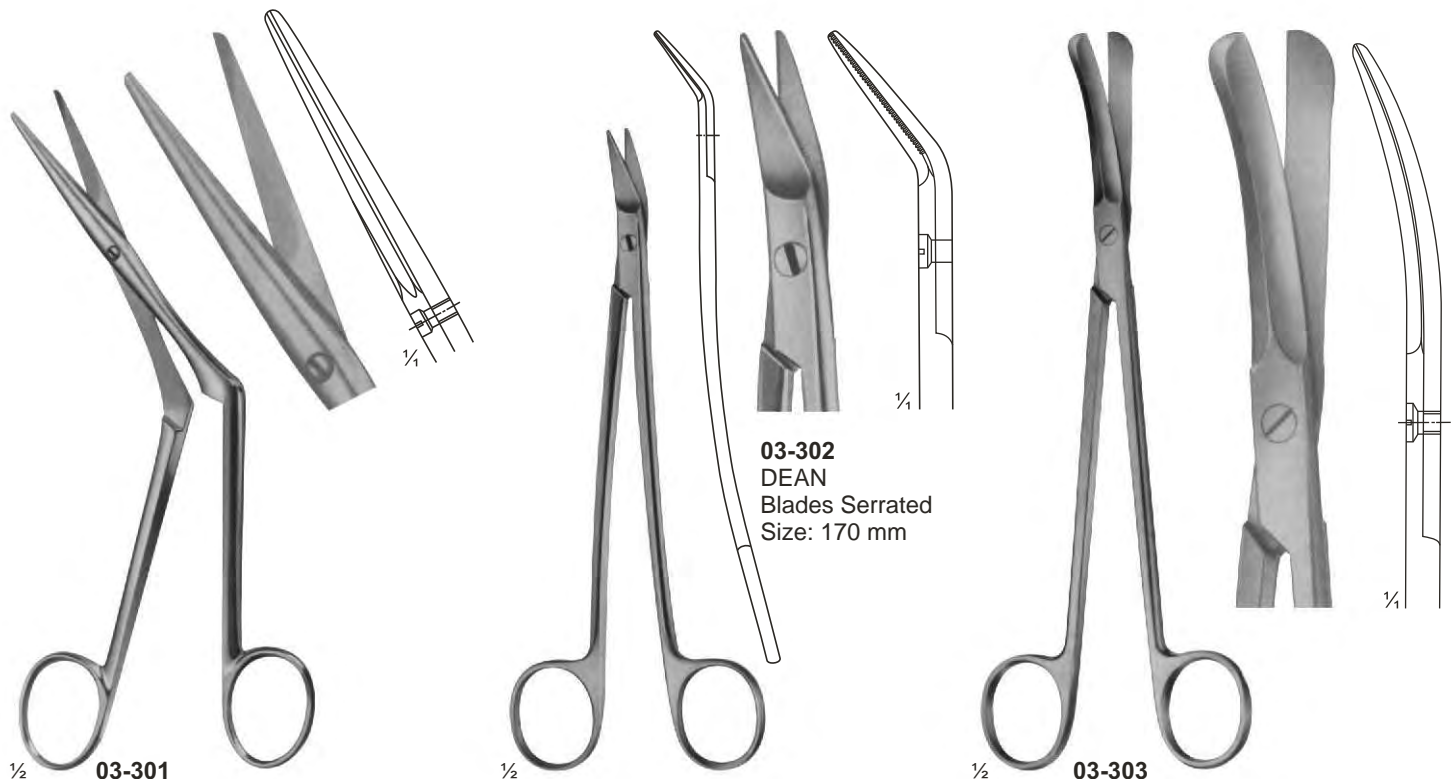

**03-301**  
HEYMANN-KNIGHT  
Size: 175 mm

**03-302**  
DEAN  
Blades Serrated  
Size: 170 mm

**03-303**  
GOOD  
Size: 195 mm

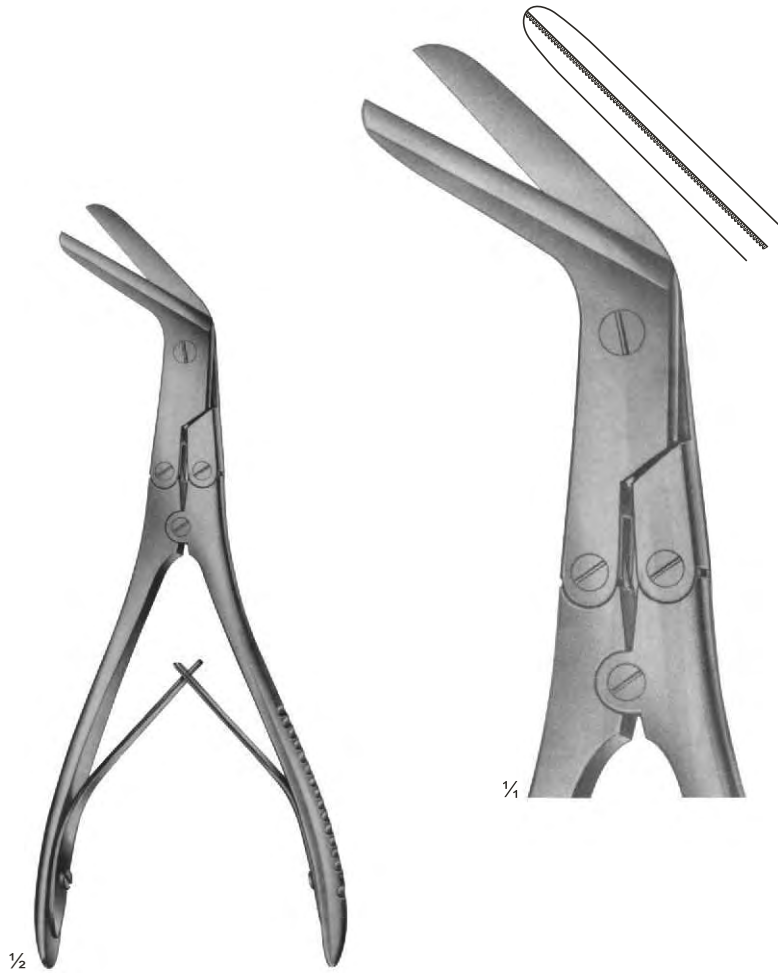

**03-304**  
KILLIAN  
Size: 200 mm



**03-305 - 306**

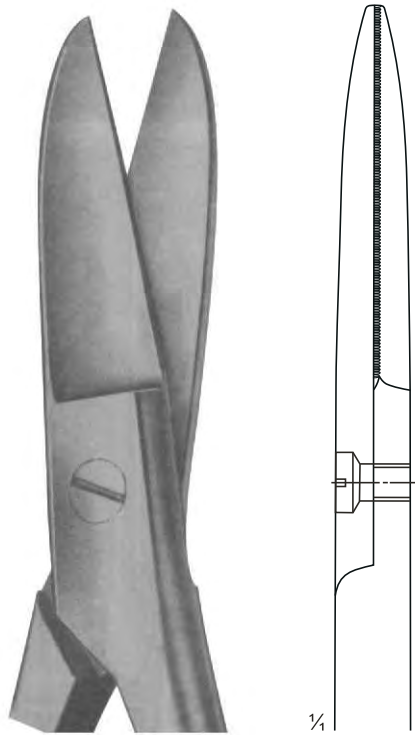

**03-305**  
195 mm

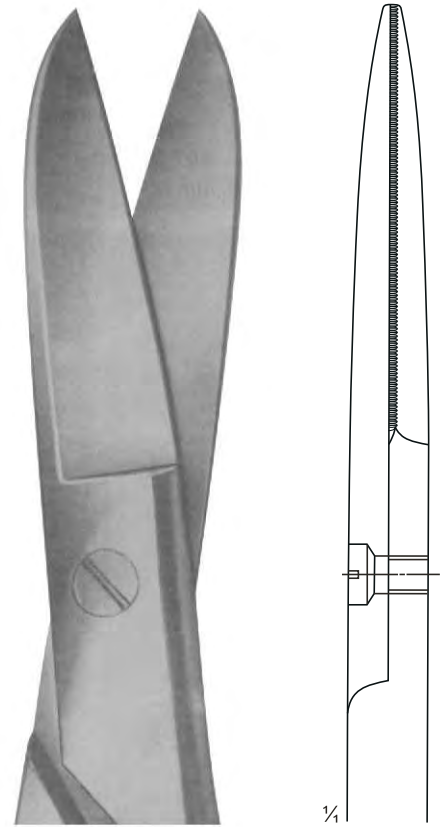

**03-306**  
225 mm

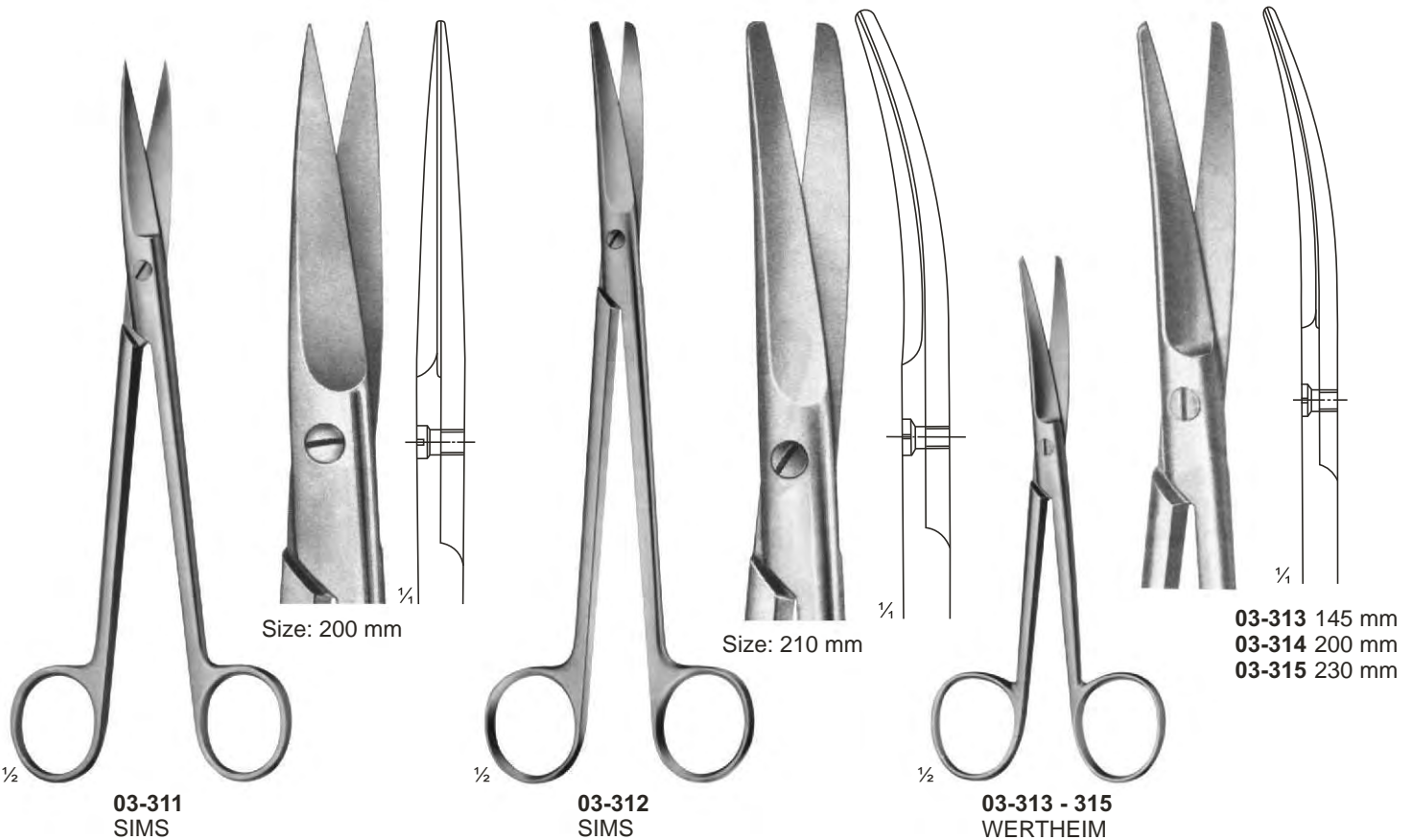
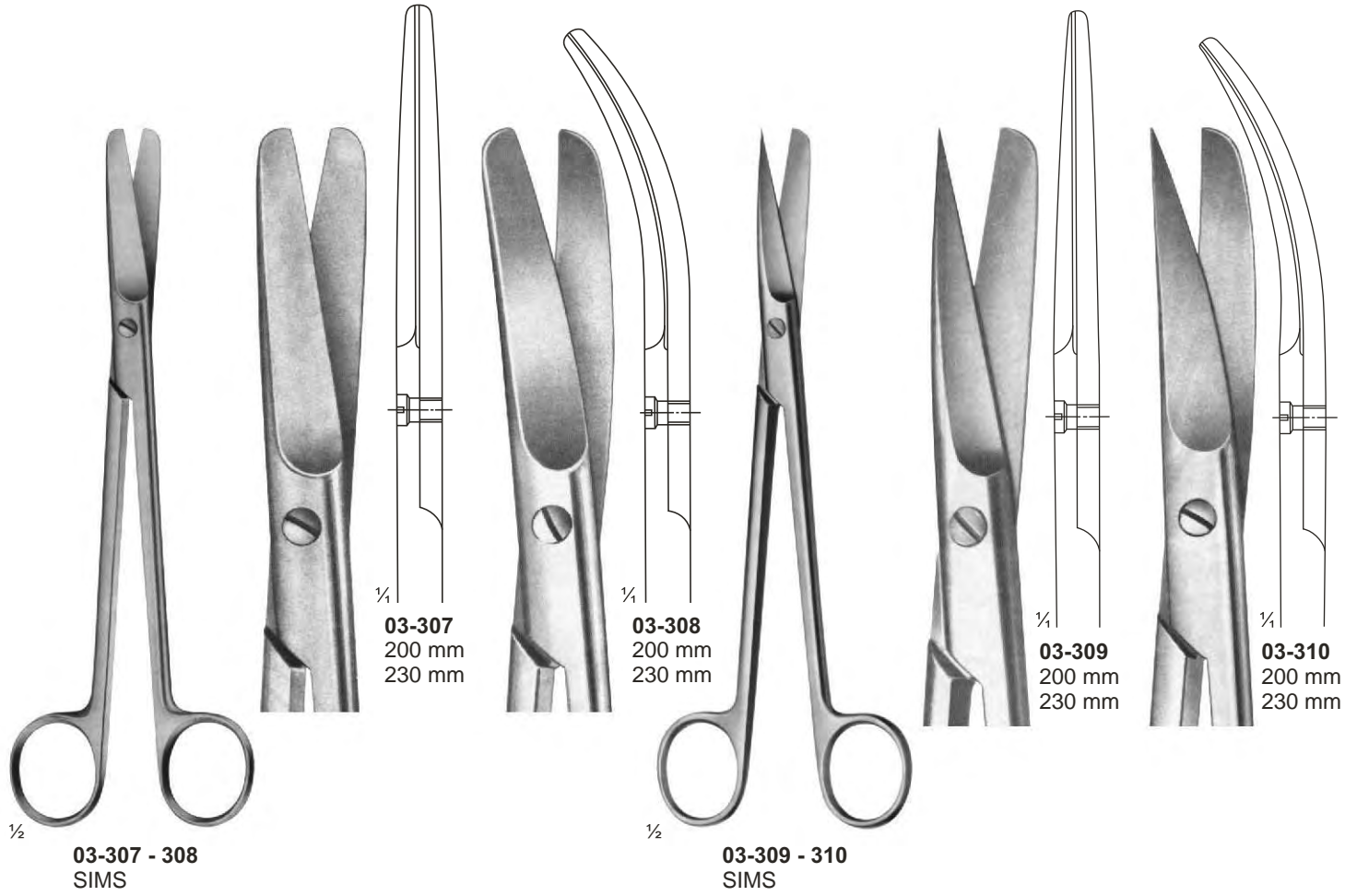

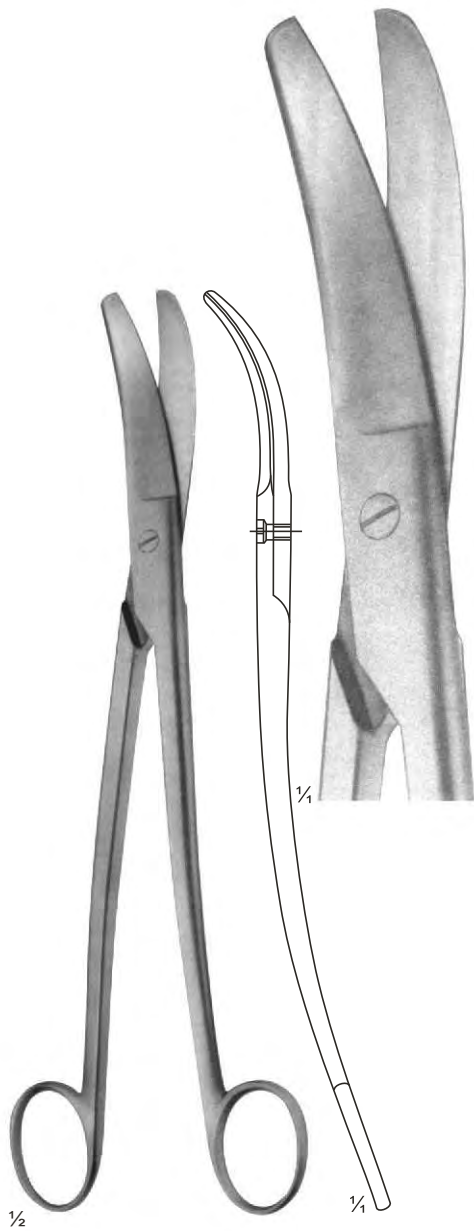

**03-316**  
**SIEBOLD**  
 Uterine Scissors  
 Size: 245 mm

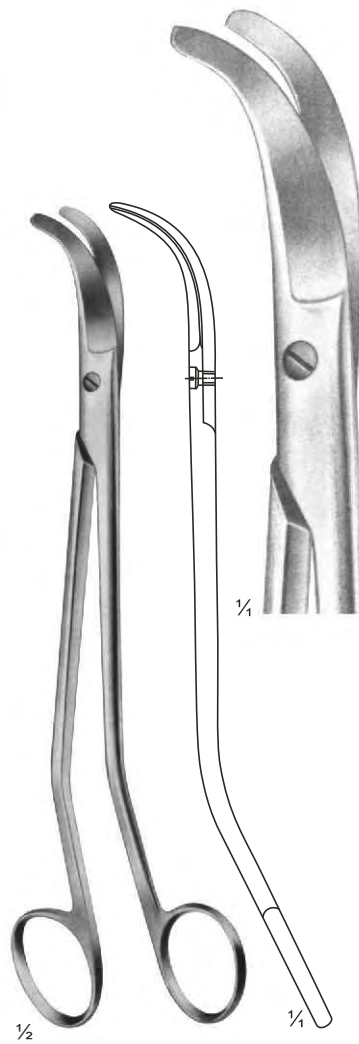

**03-317**  
**BOZEMANN**  
 Uterine Scissors  
 Size: 220 mm

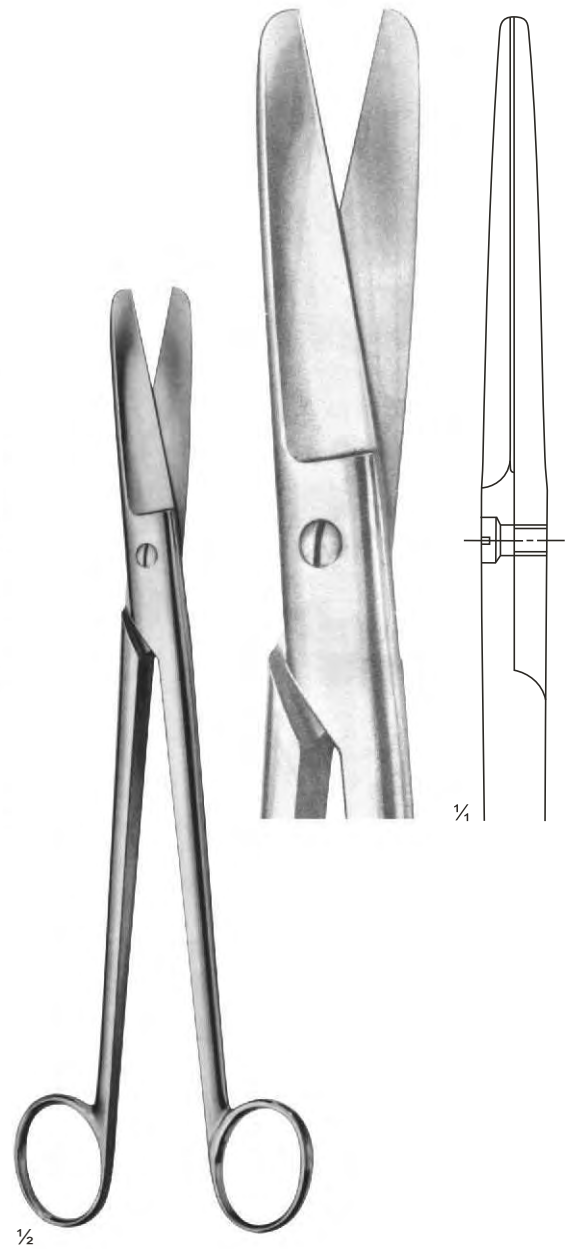

**03-318**  
**SIMS-SIEBOLD**  
 Uterine Scissors  
 Size: 250 mm

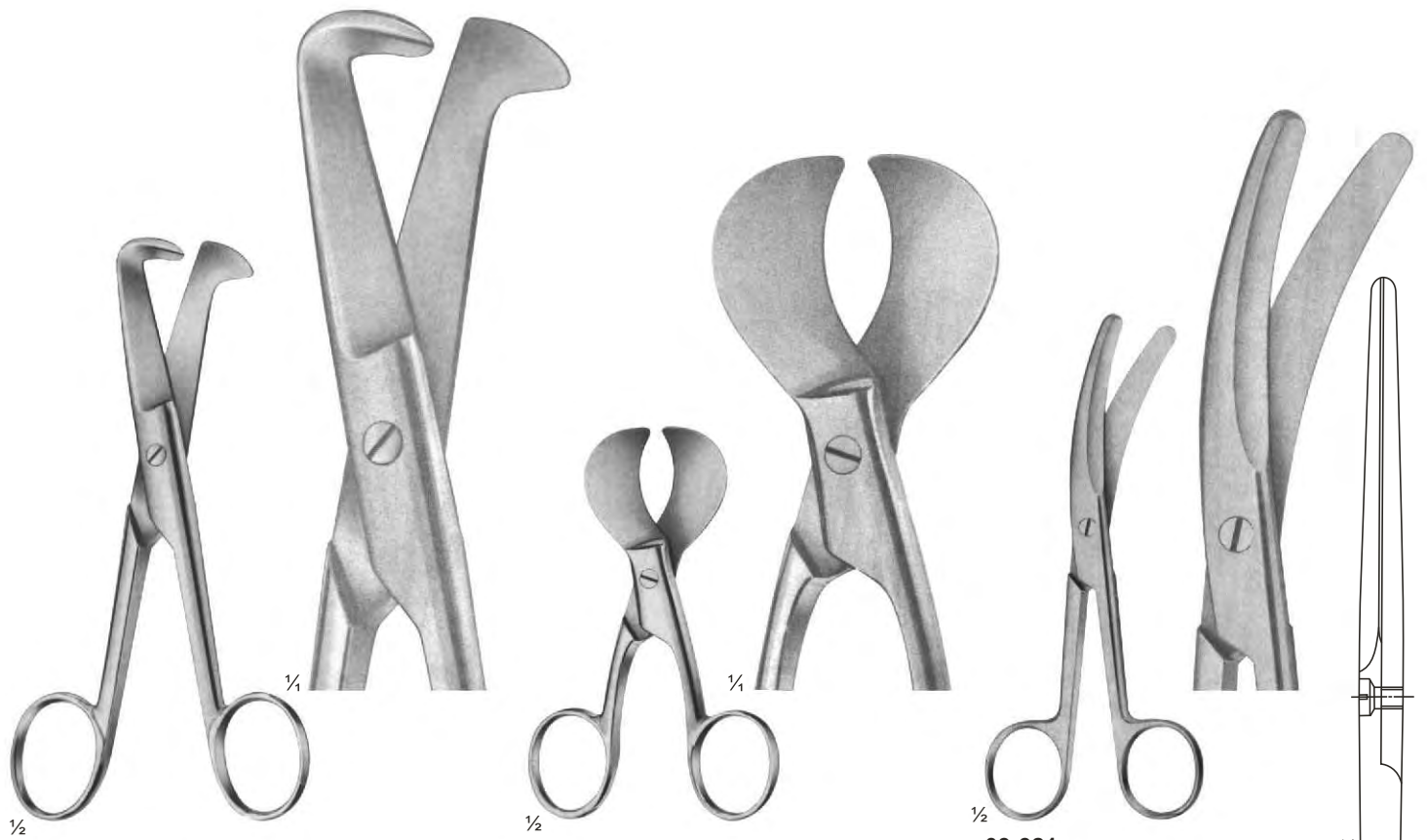

**03-319**  
SCHUMACHER  
Umbilical Cord Scissors  
Size: 155 mm

**03-320**  
Umbilical Cord Scissors  
Size: 105 mm

**03-321**  
Umbilical Cord Scissors  
135 mm

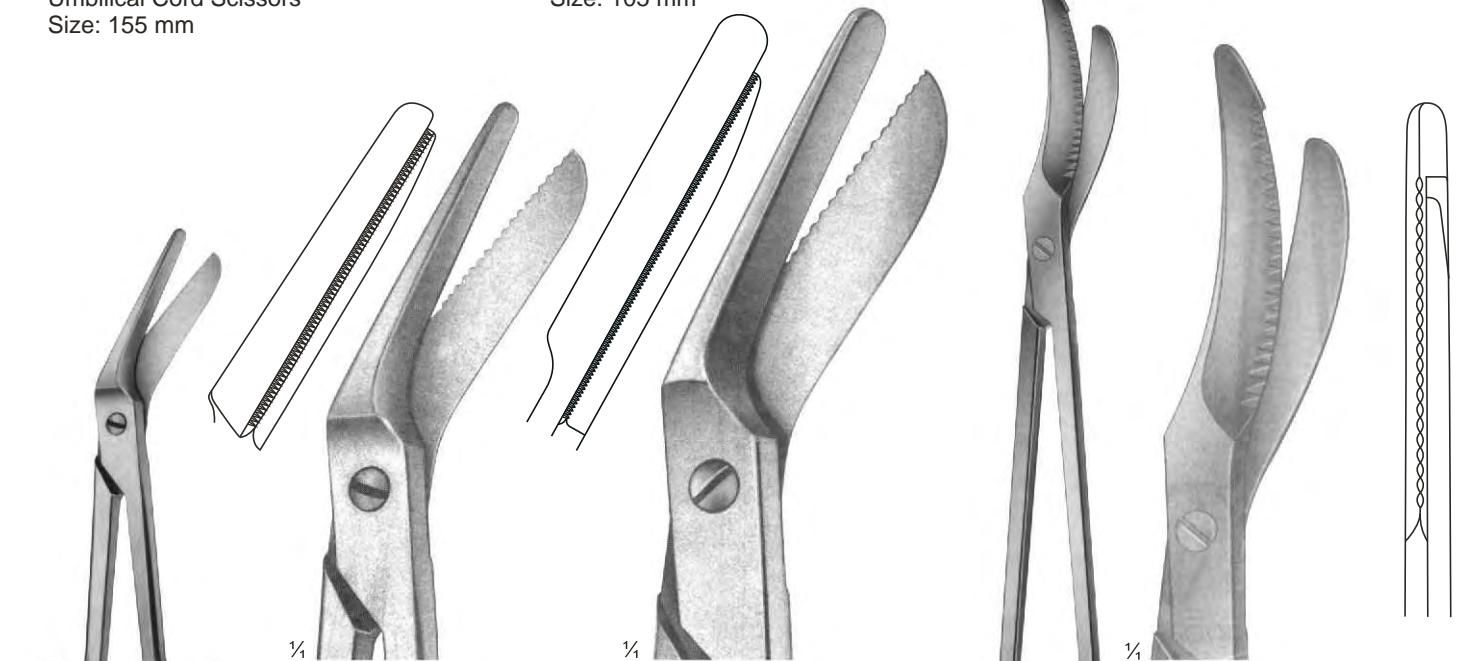

**03-322**  
145 mm

**03-323**  
200 mm

**03-324**  
DAMMSCHERE  
Empisiotomy Scissors  
240 mm

**03-322 - 323**  
BRAUN-STADLER  
Empisiotomy Scissors

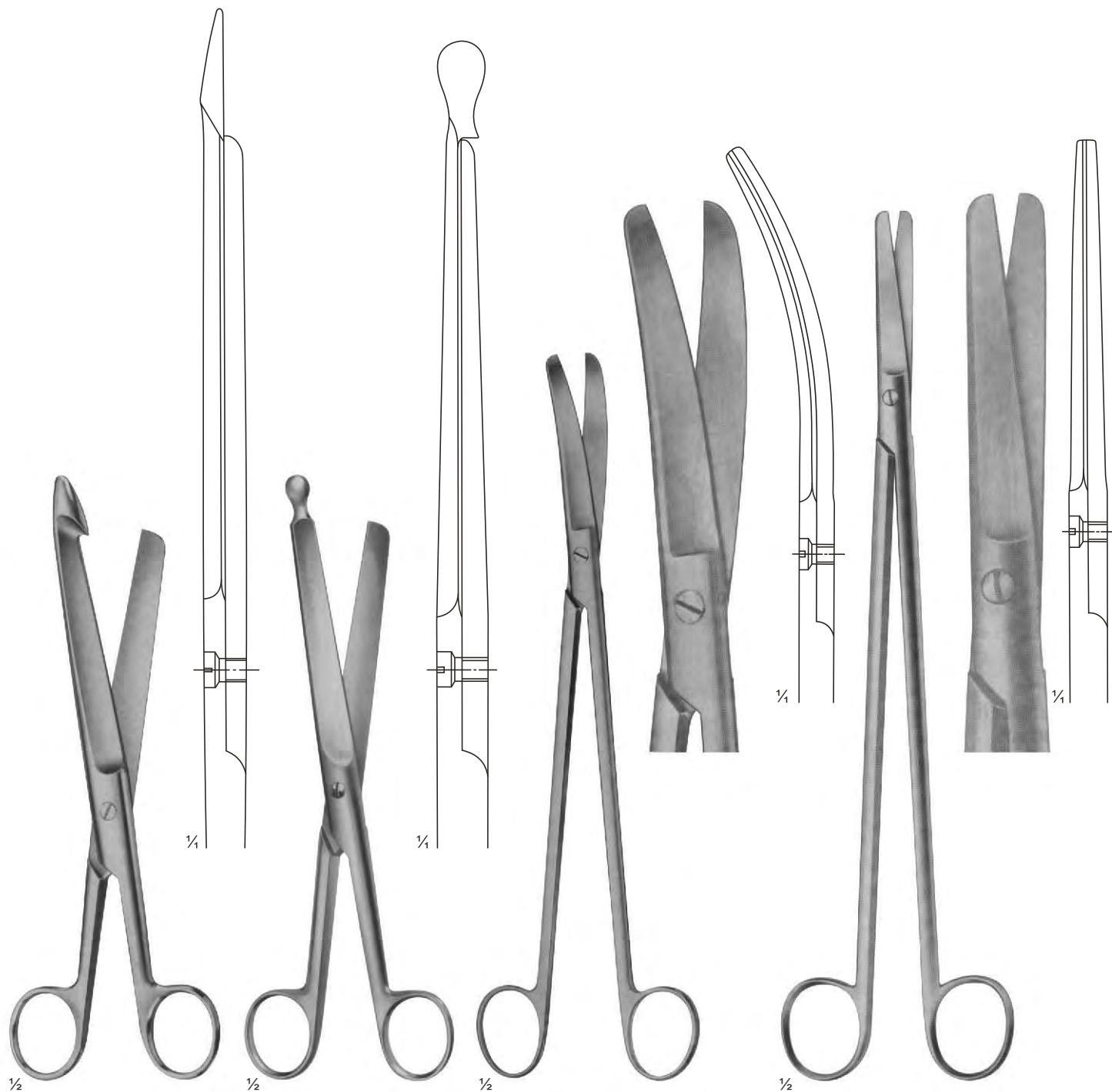

**03-325**  
DAMMSCHERE  
Bowel Scissors  
Size: 210 mm

**03-326**  
DAMMSCHERE  
Bowel Scissors  
Size: 210 mm

**03-327**  
LLOYD-DAVIES  
(GOLIGHER'S)  
Rectal Scissors  
Size: 255 mm

**03-328**  
STELZNER  
Rectal Scissors  
Size: 310 mm



**03-329 - 330**  
SPENCER

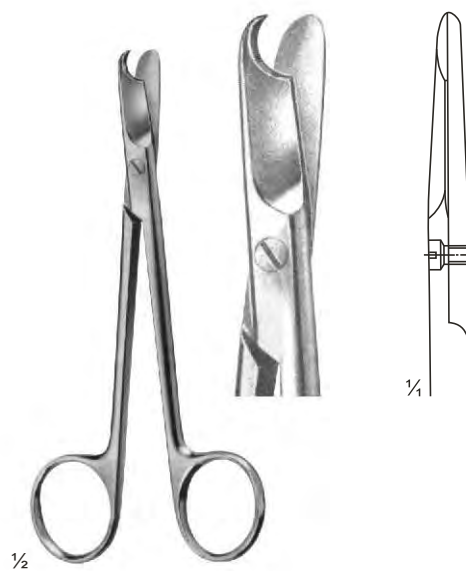

**03-331**  
LITTAUER  
Size: 135 mm

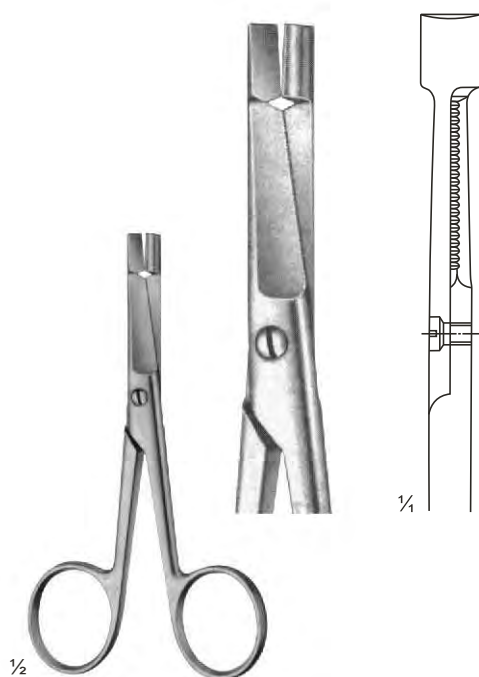

**03-332**  
EISELSBERG  
Size: 115 mm

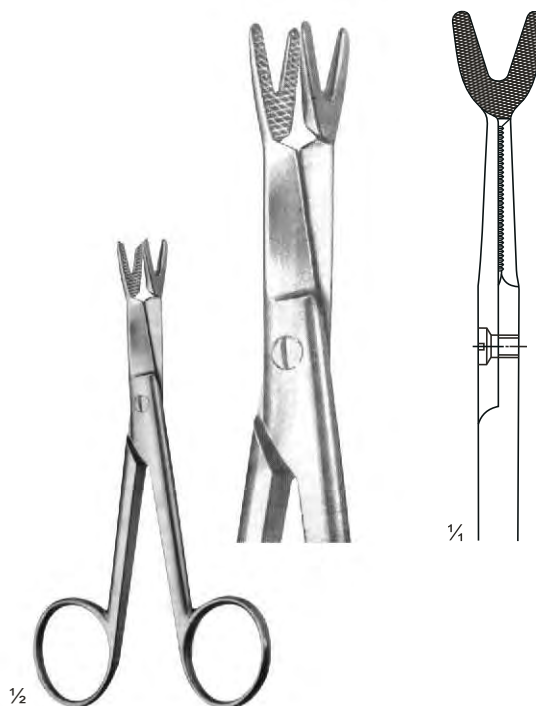

**03-333**  
SCHOEMAKER-LOTH  
Size: 125 mm



1/2

**03-334 - 338**  
BEEBE  
Size: 110 mm



1/4

**03-334**

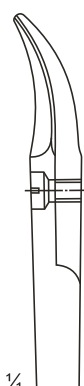

1/4

**03-335**

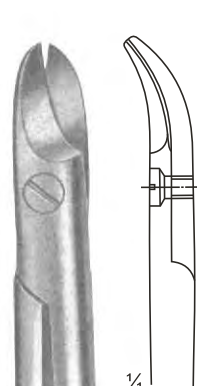

1/4

**03-336**  
Broad Blades

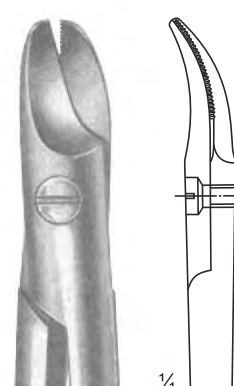

1/4

**03-337**  
1 Blade Serrated

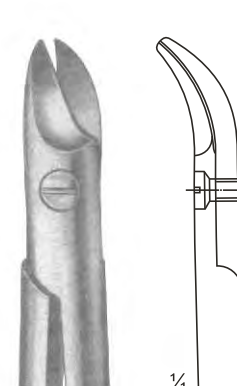

1/4

**03-338**  
NAUJOKS  
Strongly Curved

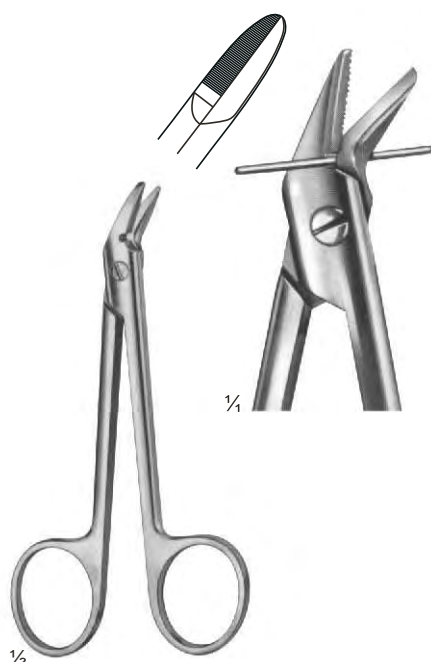

1/2

**03-339**  
1 Blade Serrated  
Size: 120 mm

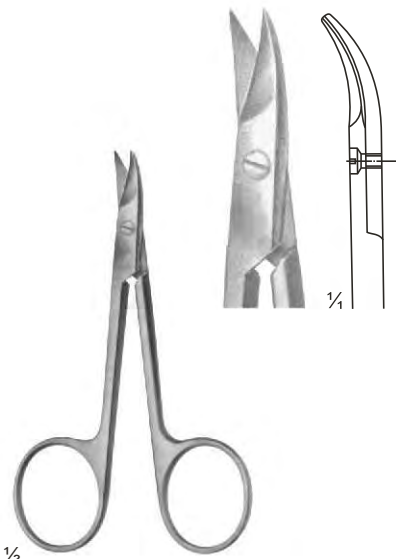

1/2

**03-340**  
STRACK  
Size: 100 mm

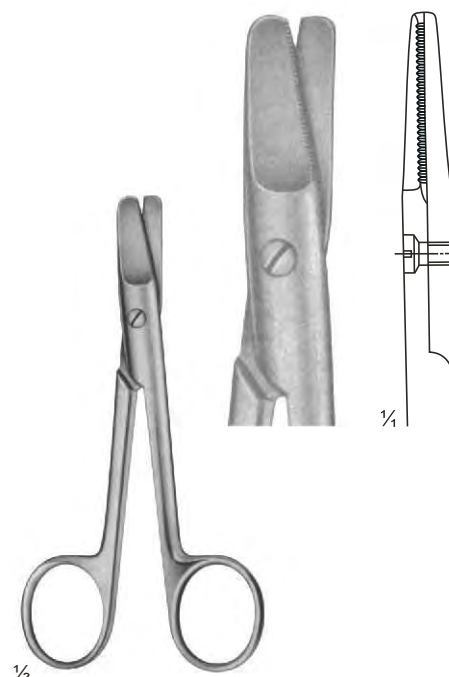

1/2

**03-341**  
HARVEY  
Size: 125 mm

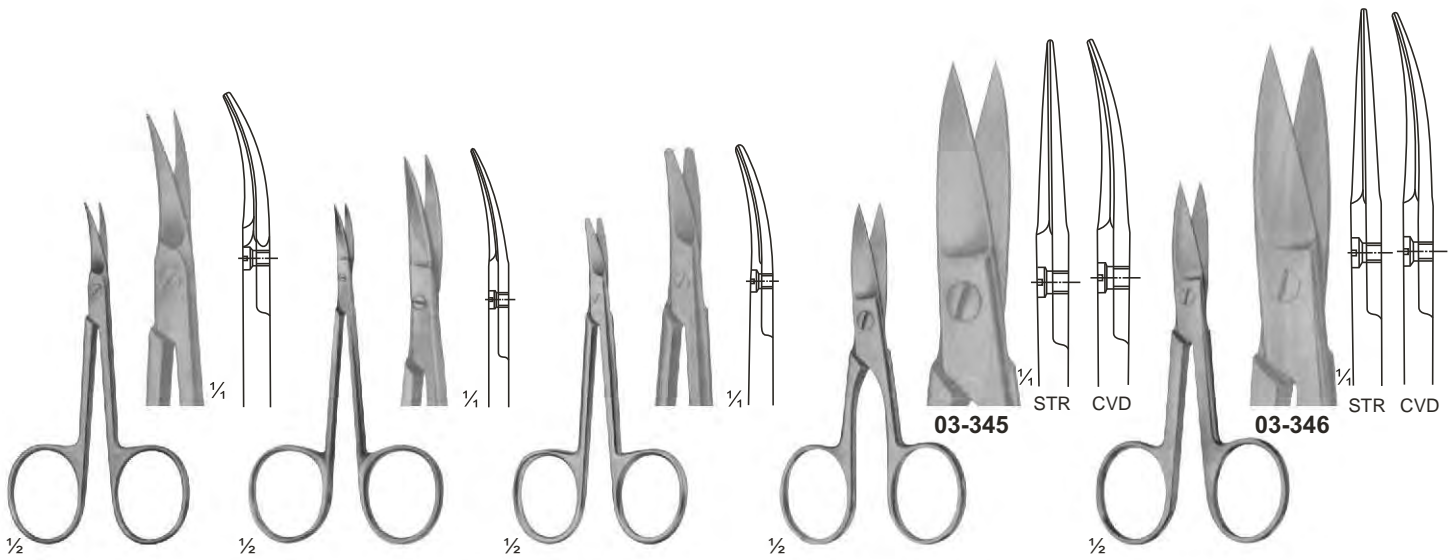

**03-342**  
NAIL SCISSORS  
Size: 90 mm

**03-343**  
NAIL SCISSORS  
Size: 90 mm

**03-344**  
BABY NAIL SCISSORS  
Size: 85 mm

**03-345**  
NAIL SCISSORS  
Size: 90 mm

**03-346**  
NAIL SCISSORS  
Size: 90 mm

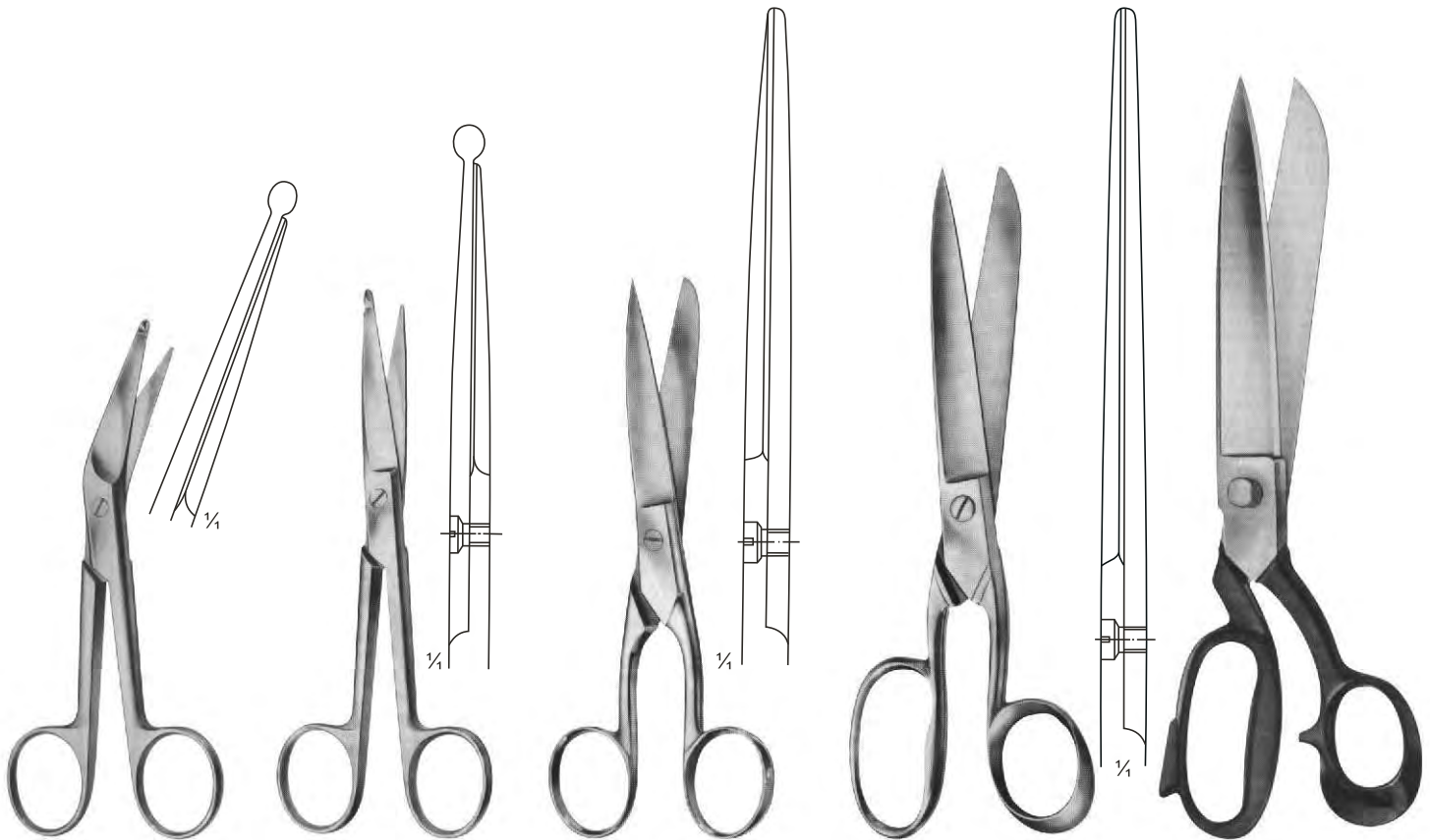

**03-347**  
KNOWLES  
Size: 140 mm

**03-348**  
KNOWLES  
Size: 145 mm

**03-349**  
Size: 150 mm

**03-350**  
SMITH  
Size: 180 mm

**03-351**  
Size: 310 mm



**03-352**  
UNIVERSAL AND BANDAGE SCISSORS  
180 mm

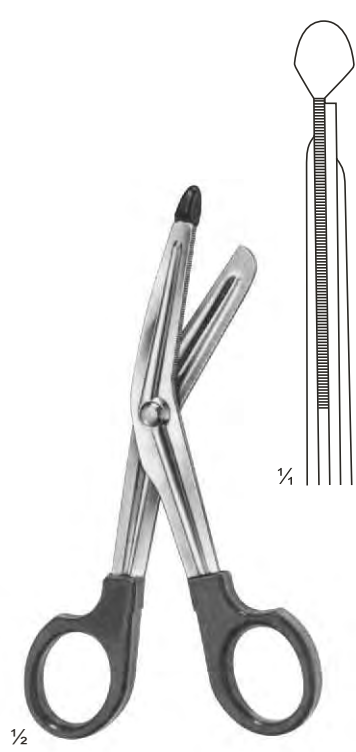

**03-353**  
LISTER  
Size: 145 mm

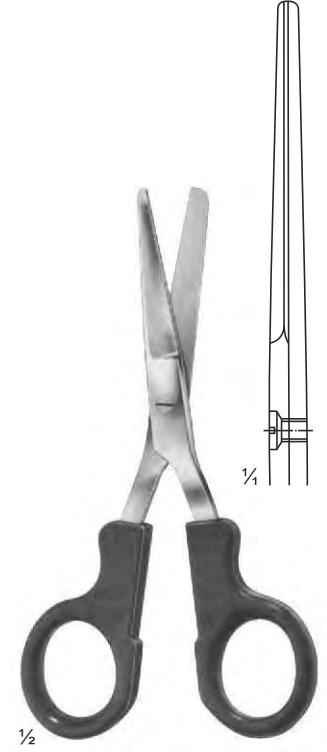

**03-354**  
LISTER  
Size: 145 mm

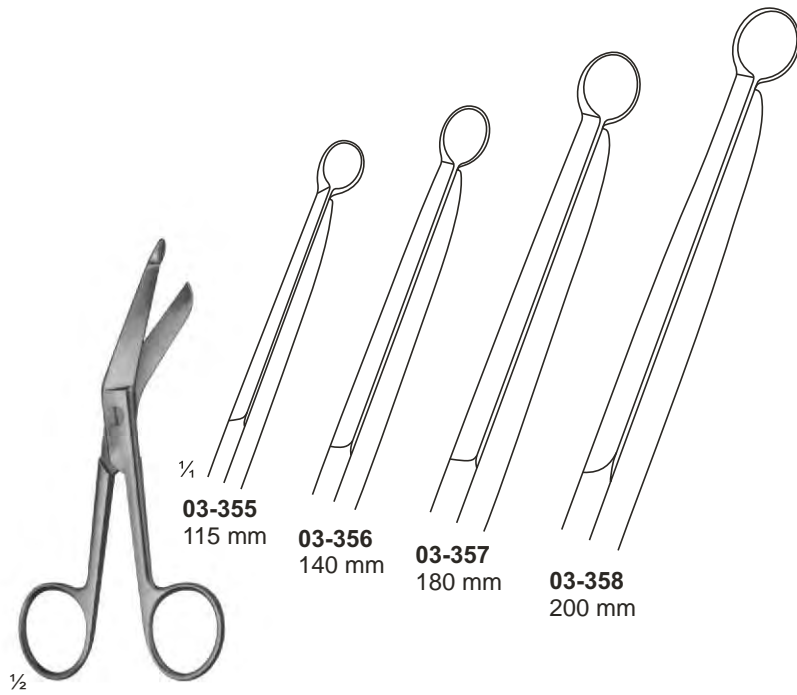

**03-355 - 358**  
LISTER

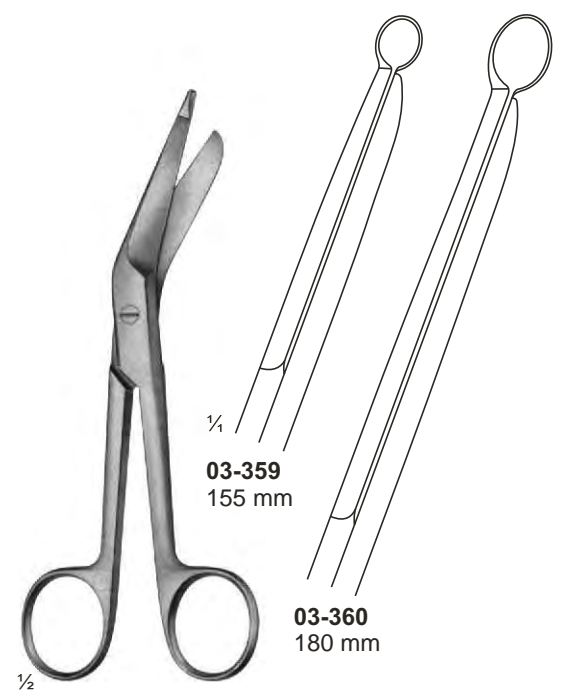

**03-359 - 360**  
LISTER

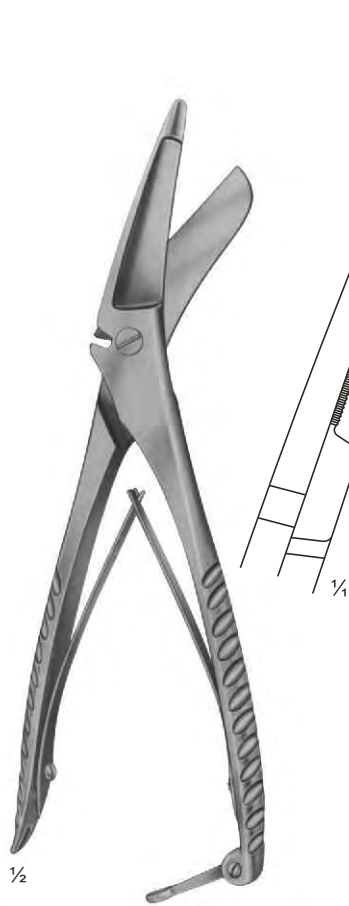

**03-361**  
CLOTH SCISSORS  
205 mm

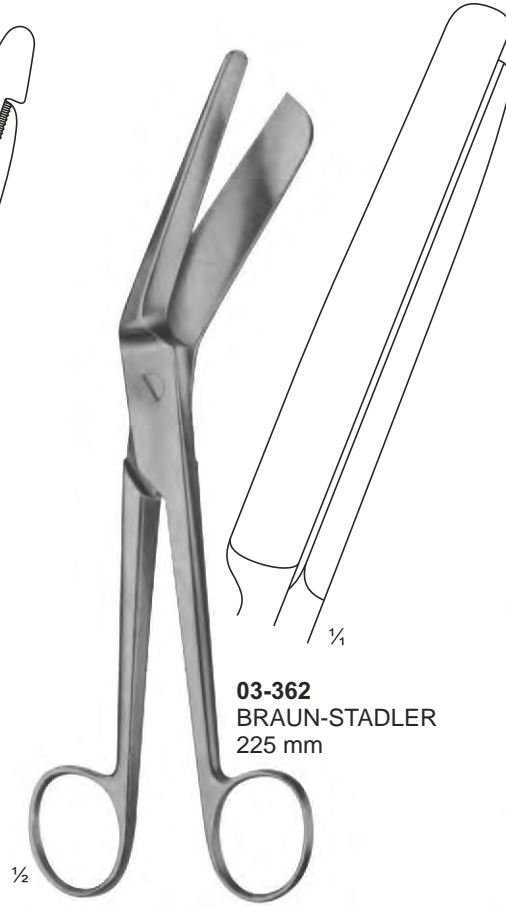

**03-362**  
BRAUN-STADLER  
225 mm

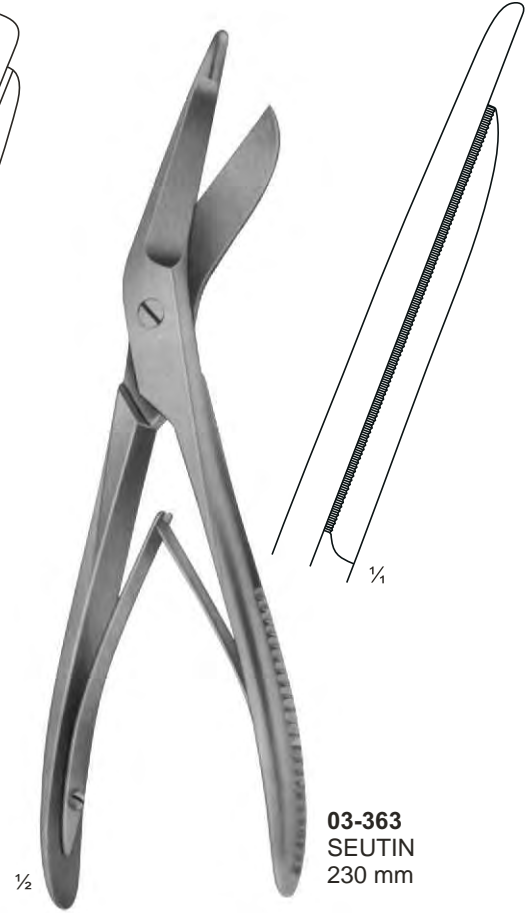

**03-363**  
SEUTIN  
230 mm

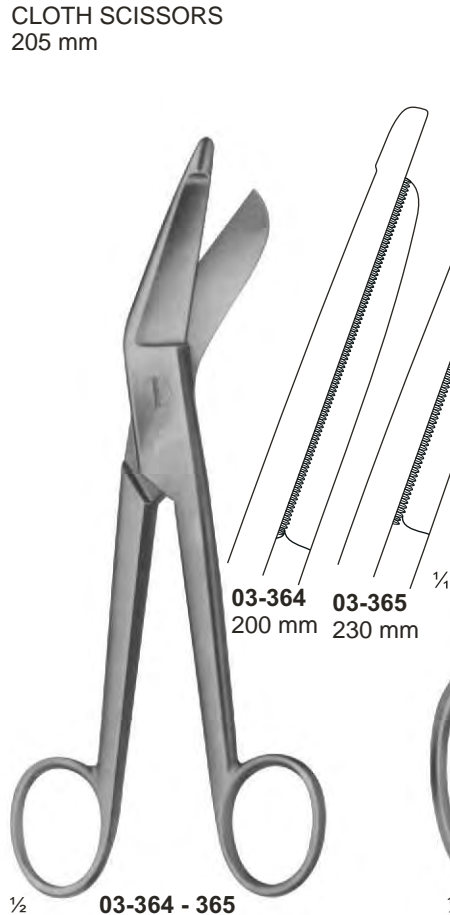

**03-364** **03-365**  
200 mm 230 mm

**03-364 - 365**  
ESMARCH

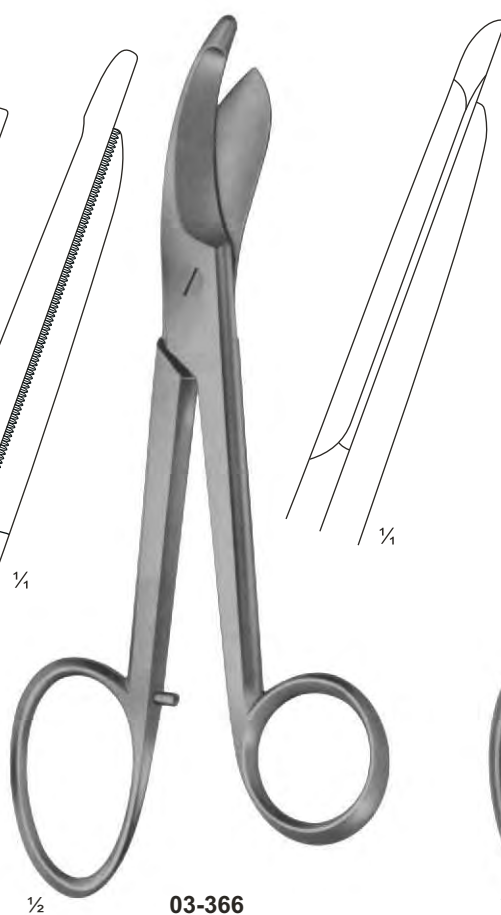

**03-366**  
BRUNS  
235 mm

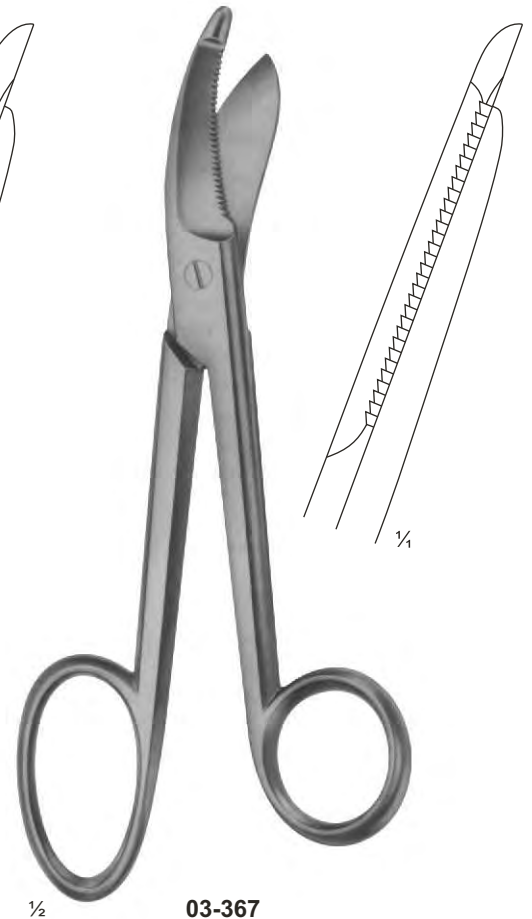

**03-367**  
BRUNS  
235 mm

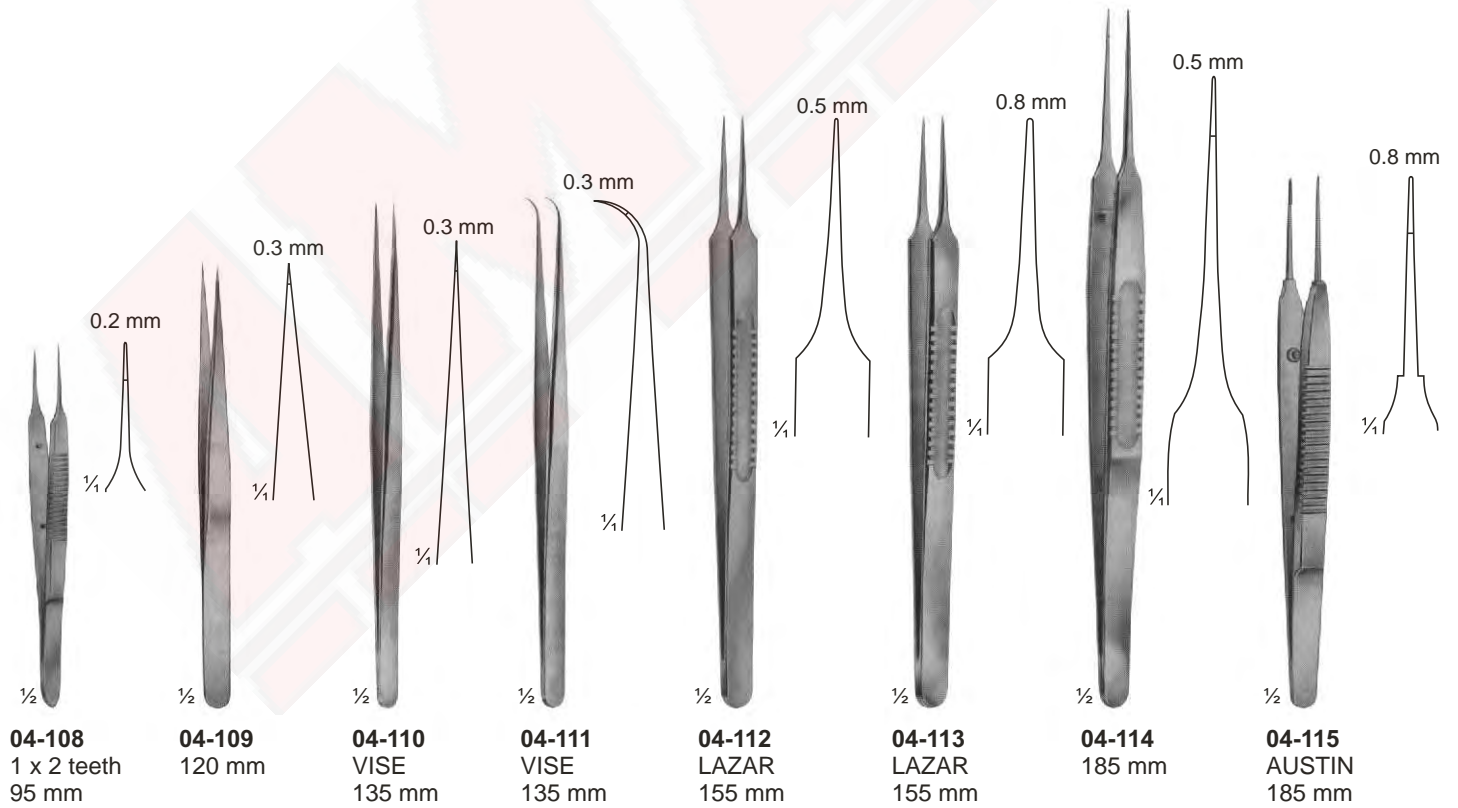
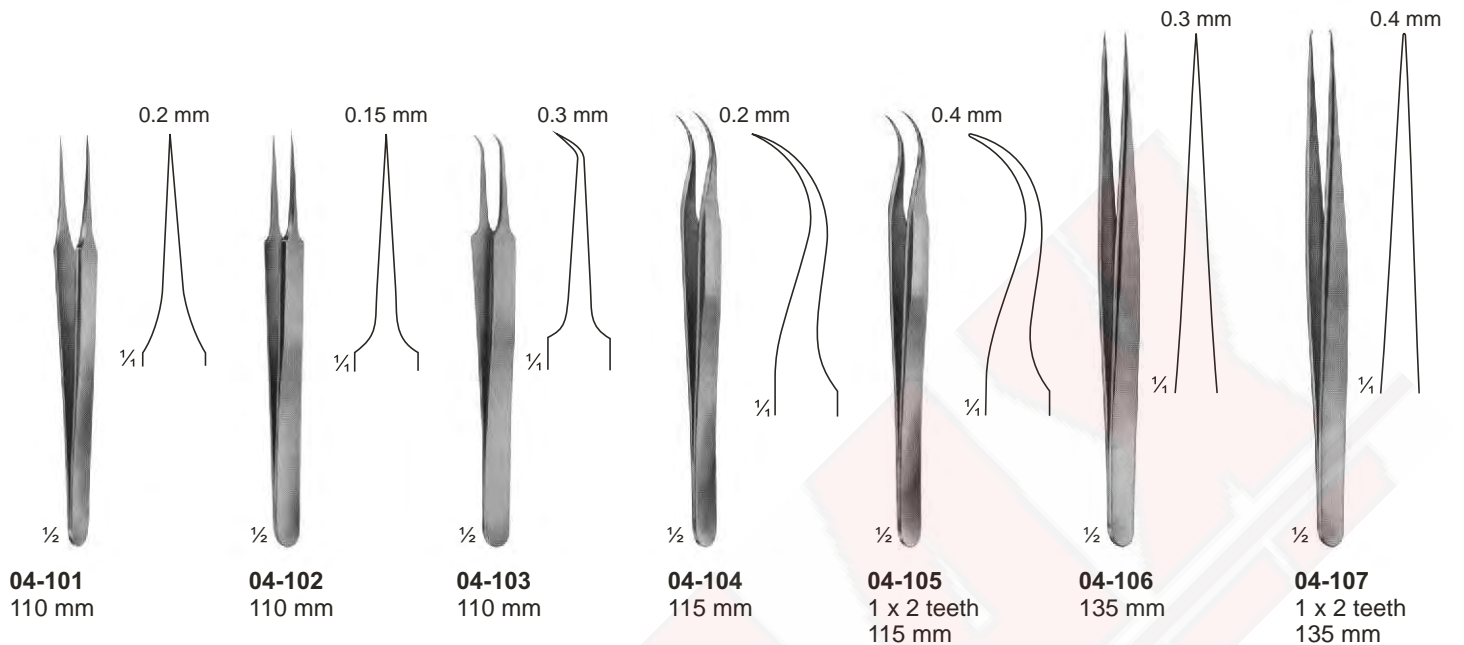

# Ligature Forceps, Micro Forceps (Light Patterns)

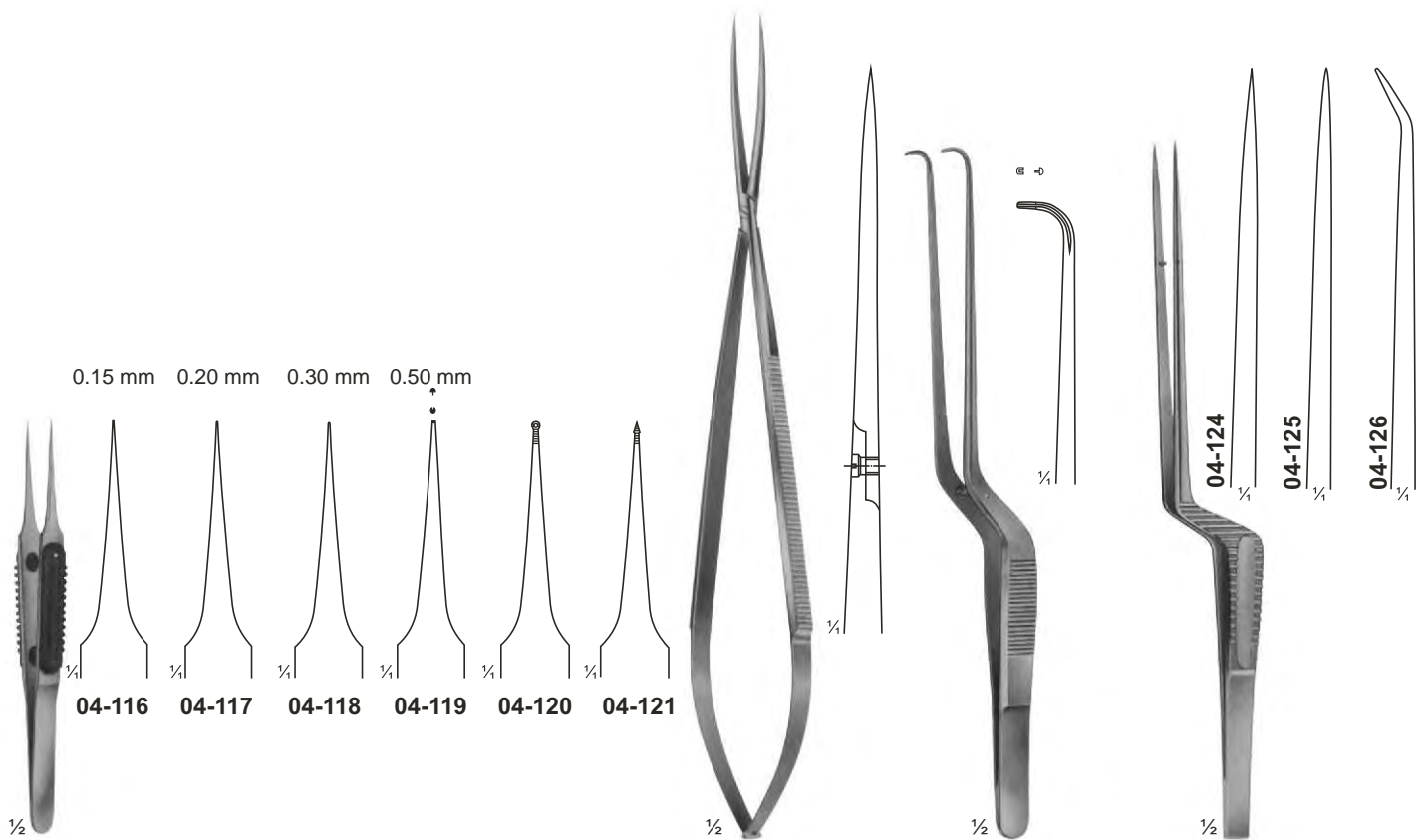

**04-116 - 121**  
MULLER  
110 mm

**04-122**  
LIGATURE FORCEPS  
220 mm

**04-123**  
YASARGIL  
185 mm

**04-124 - 126**  
MICRO FORCEPS  
185 mm

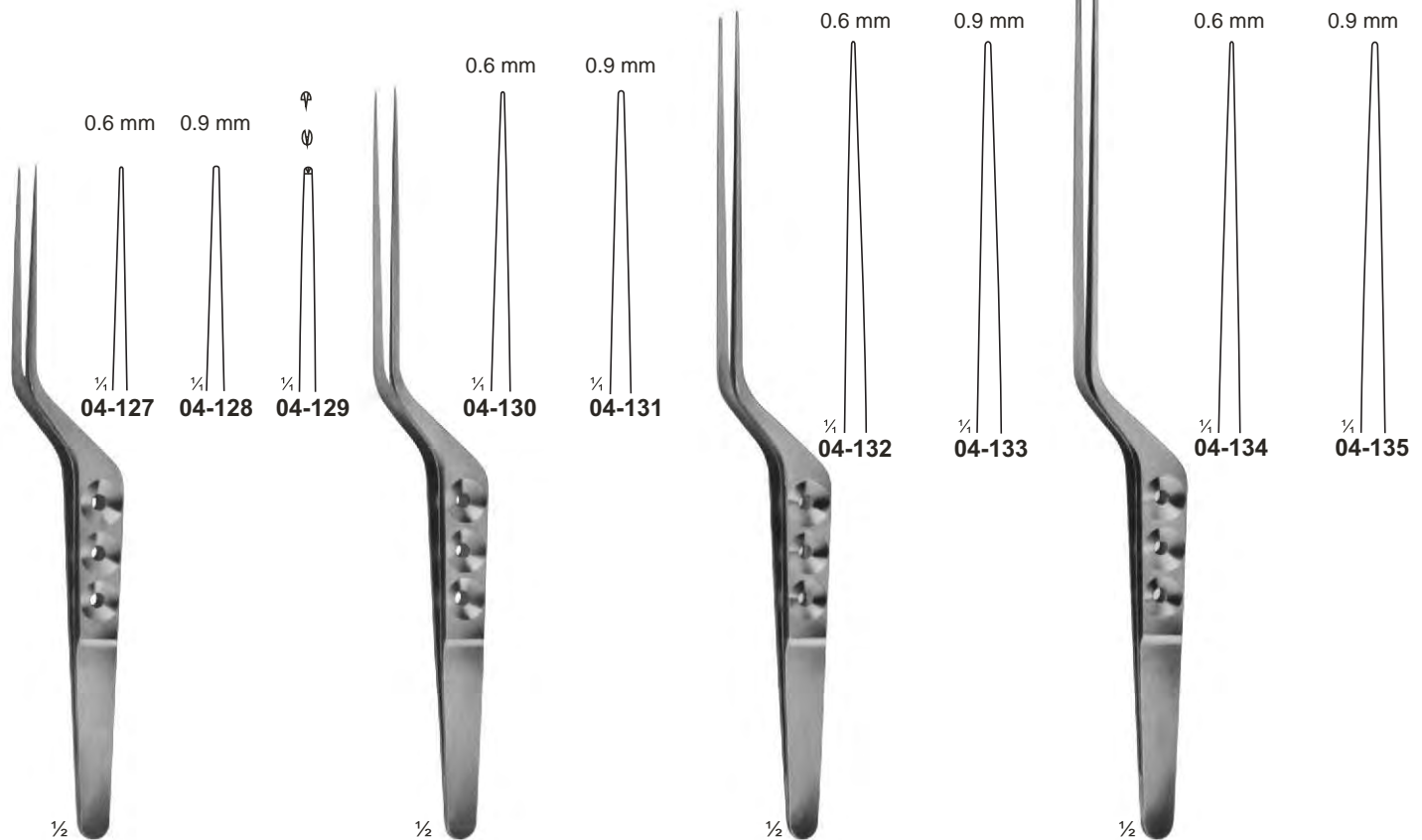

**04-127 - 129**  
YASARGIL  
180 mm

**04-130 - 131**  
YASARGIL  
200 mm

**04-132 - 133**  
YASARGIL  
220 mm

**04-134 - 135**  
YASARGIL  
240 mm



# Ligature Forceps, Micro Forceps (Light Patterns)

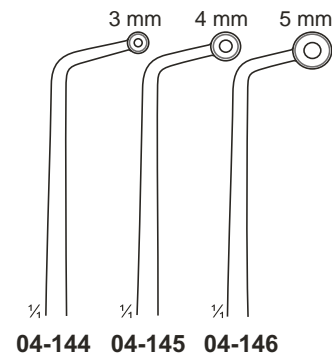
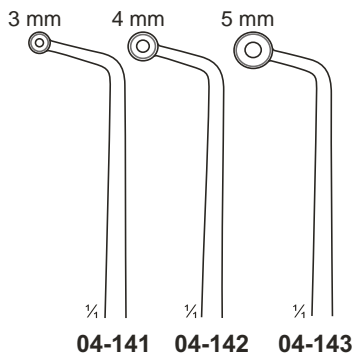
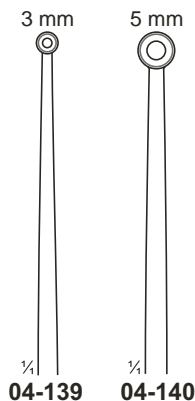
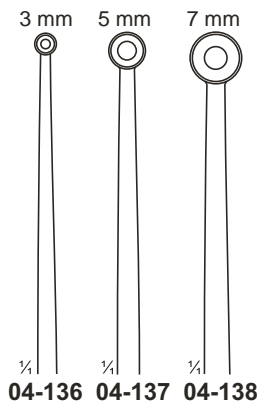

1/2

1/2

1/2

1/2

1/2

**04-136 - 138**  
YASARGIL-SAMI  
Jaws Spoon-Shaped  
240 mm

**04-139 - 140**  
YASARGIL  
Jaws Spoon-Shaped  
220 mm

**04-141 - 143**  
SAMII  
Jaws Spoon-Shaped  
230 mm

**04-144 - 146**  
SAMII  
Jaws Spoon-Shaped  
230 mm

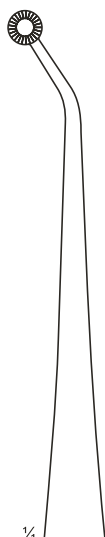

**04-147** 1/2  
HUNT  
Tumor-and Vessel Forceps  
200 mm

**04-148** 1/2  
HUNT  
Tumor-and Vessel Forceps  
200 mm

**04-149** 1/2  
YASARGIL  
Tumor-and Vessel Forceps  
200 mm

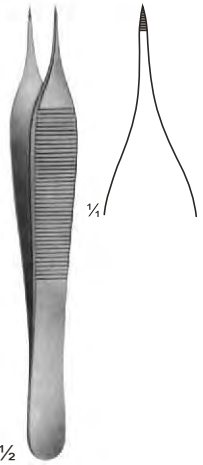

**04-150**  
THORPE  
Corneal Forceps  
120 mm

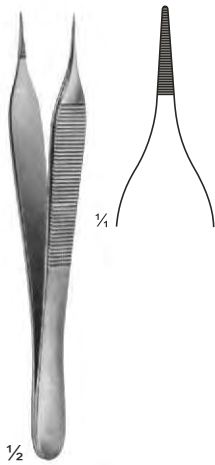

**04-151**  
MICRO-ADSON  
120 mm

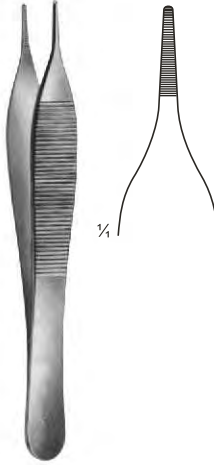

**04-152**  
ADSON  
120 mm

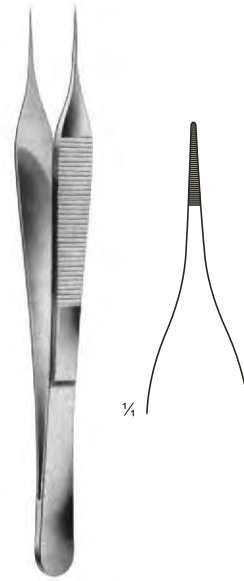

**04-153**  
MICRO-ADSON  
150 mm



**04-154 - 156**  
100 mm



**04-154**



**04-155**



**04-156**

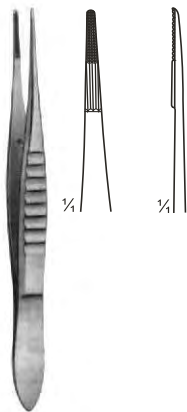

**04-157**  
110 mm

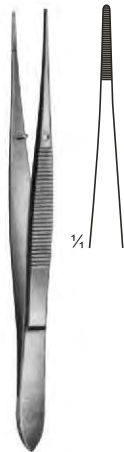

**04-158**  
115 mm



**04-159 - 168**



**04-159**  
90 mm



**04-160**  
105 mm



**04-161**  
115 mm



**04-162**  
130 mm



**04-163**  
145 mm



**04-164**  
90 mm



**04-165**  
105 mm



**04-166**  
115 mm



**04-167**  
130 mm



**04-168**  
145 mm



**04-169**  
100 mm

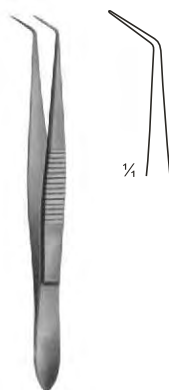

**04-170**  
100 mm



**04-171**  
100 mm

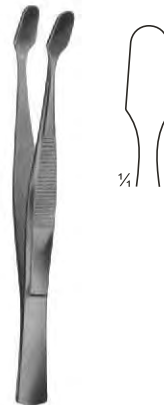

**04-172**  
COVER GLASS FORCEPS  
105 mm



**04-173**  
160 mm

# Delicate Dissecting Forceps

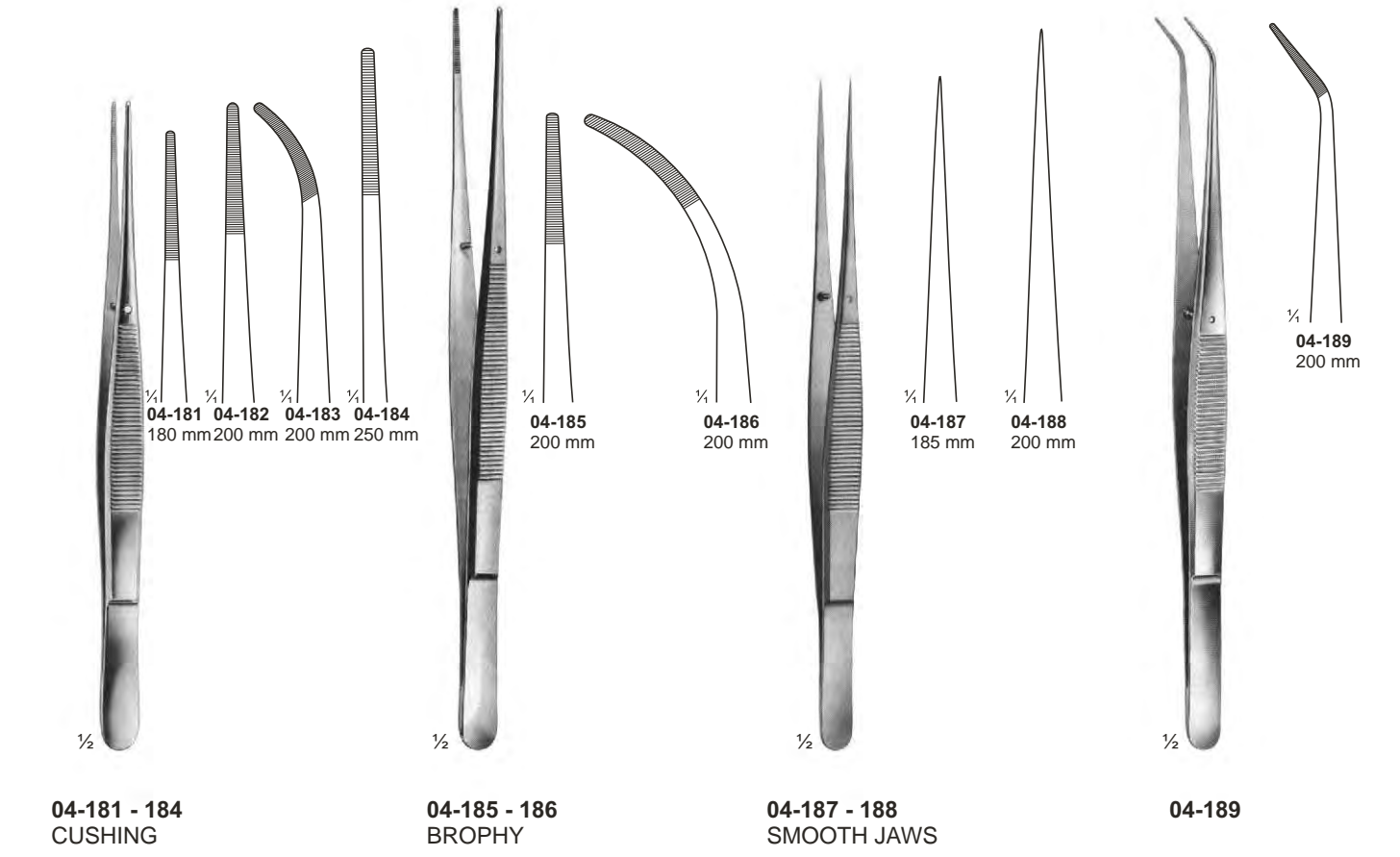
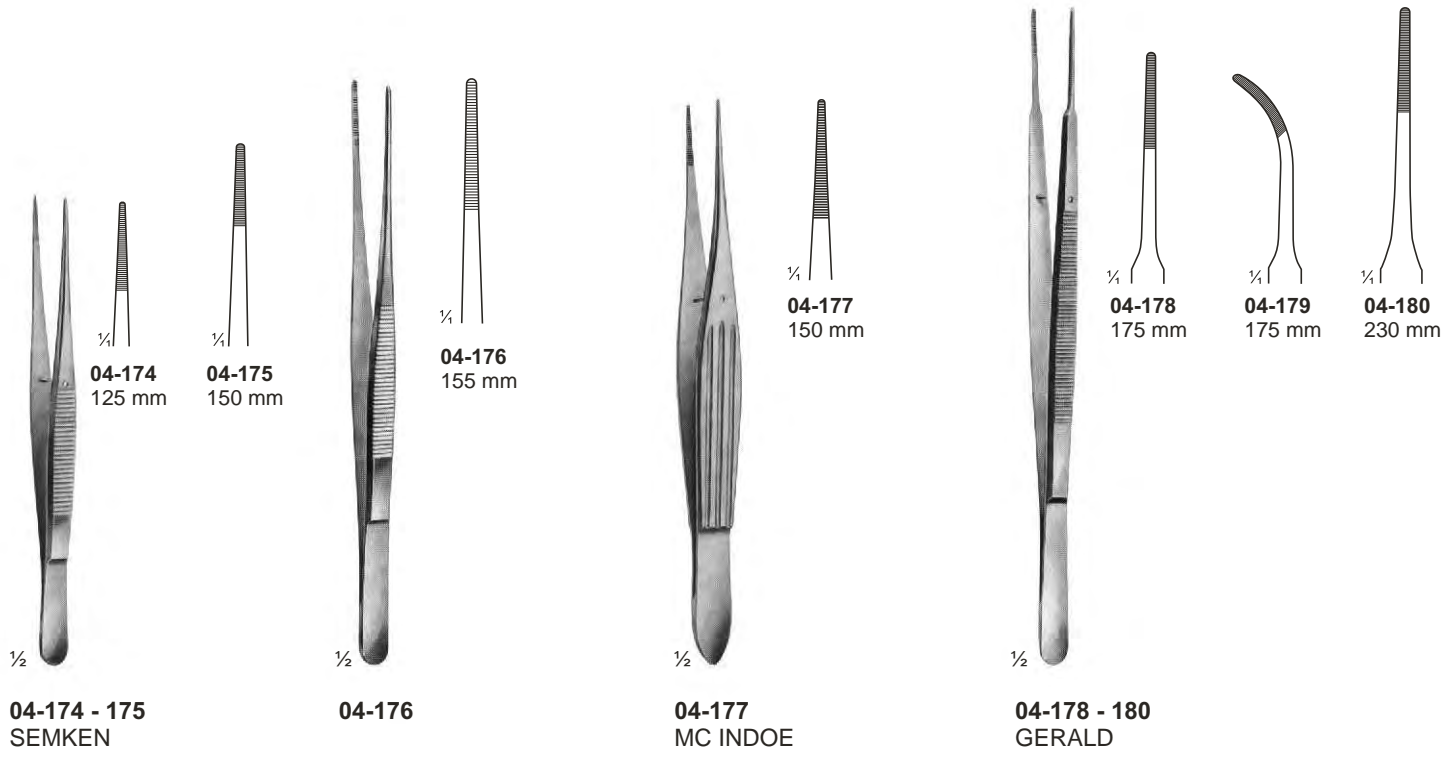

# Dissecting Forceps



½



**04-190**  
115 mm



**04-191**  
130 mm



**04-192**  
145 mm



**04-193**  
160 mm



**04-194**  
180 mm



**04-195**  
200 mm



**04-196**  
250 mm

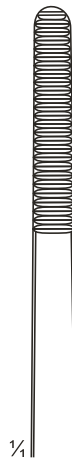

**04-197**  
300 mm

**04-190 - 197**  
STANDARD



½

**04-198 - 202**  
MEDIUM



**04-198**  
115 mm



**04-199**  
130 mm



**04-200**  
145 mm



**04-201**  
160 mm



**04-202**  
305 mm



½

**04-203 - 204**  
MEDIUM



**04-203**  
130 mm

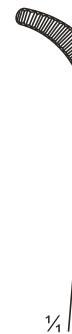

**04-204**  
145 mm



1/2

**04-205 - 206**



1/4

**04-205**  
125 mm



1/4

**04-206**  
155 mm



1/2

**04-207 - 210**

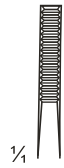

1/4

**04-207**  
130 mm



1/4

**04-208**  
150 mm



1/4

**04-209**  
170 mm

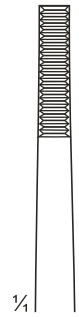

1/4

**04-210**  
200 mm



1/2

**04-211**  
OCHSNER

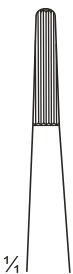

1/4



1/2

**04-212**  
FRICKE



1/4



1/2

**04-213**  
BONNEY

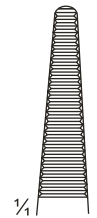

1/4

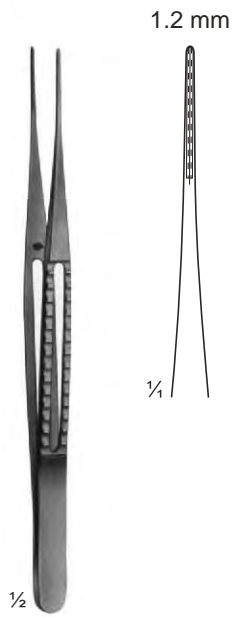

**04-214**  
150 mm

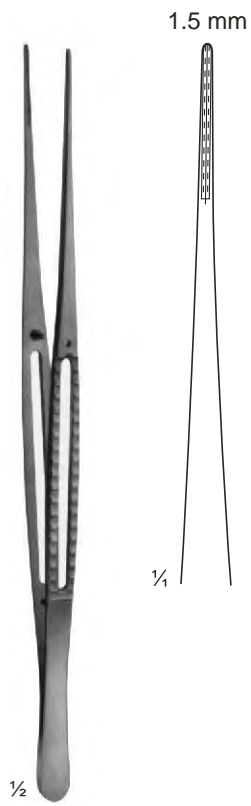

**04-215**  
200 mm

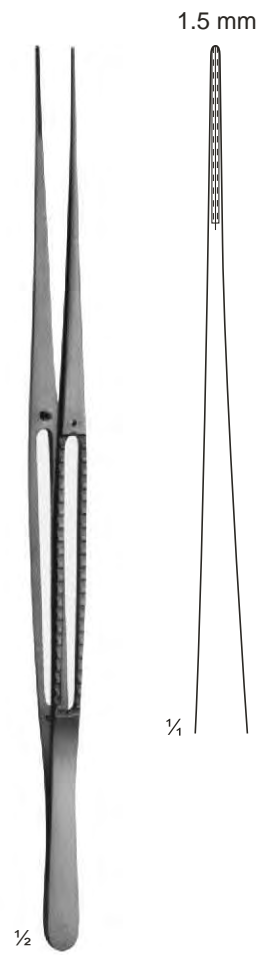

**04-216**  
240 mm

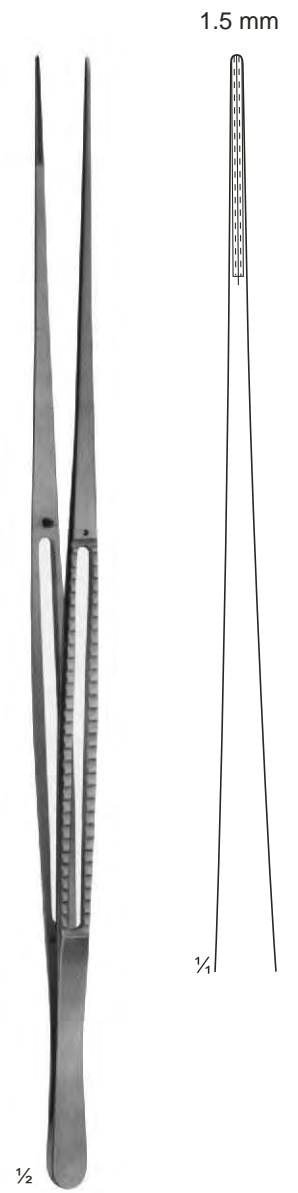

**04-217**  
300 mm

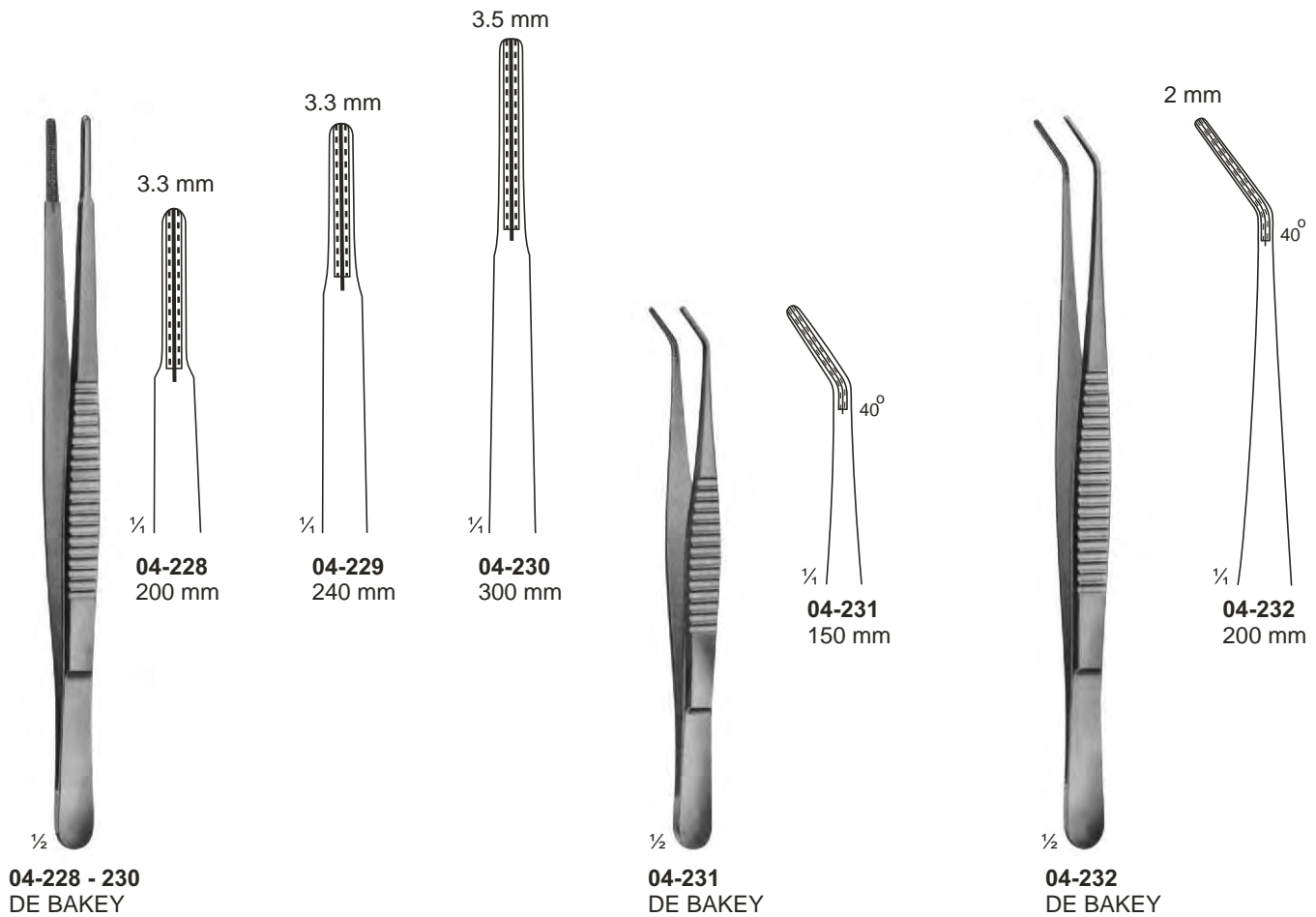
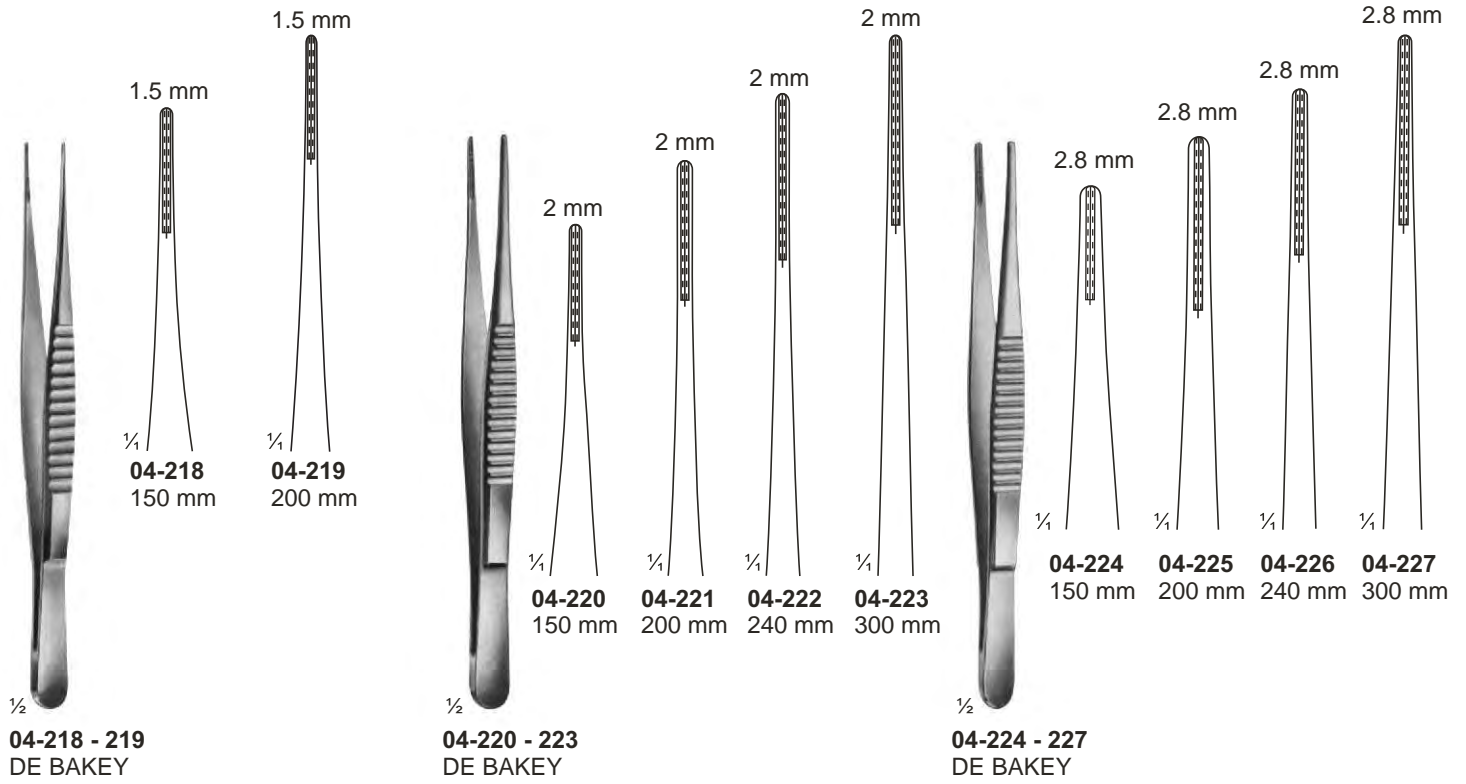



**04-233**  
LUCAE  
140 mm



**04-234**  
LUCAE  
1x2 teeth  
140 mm



**04-235**  
COTTLE  
Forceps with  
jaws toothed  
and serrated  
140 mm



**04-236**  
JANSEN  
160 mm

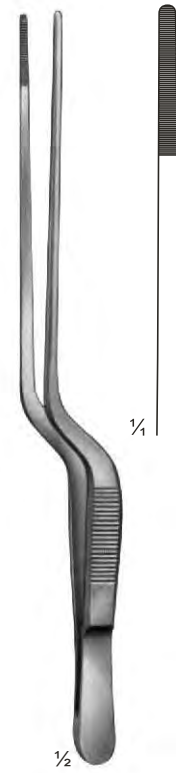

**04-237**  
GRUENWALD  
200 mm



**04-238**  
1x2 teeth  
200 mm

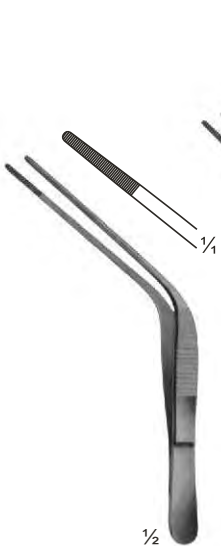

**04-239**  
TROELTSCH  
100 mm

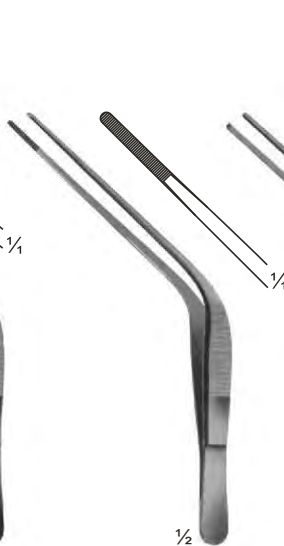

**04-240**  
TROELTSCH  
115 mm

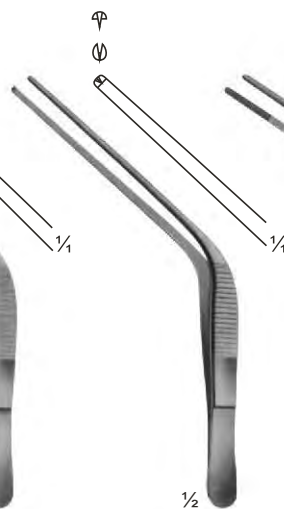

**04-241**  
TROELTSCH  
1X2 teeth  
115 mm

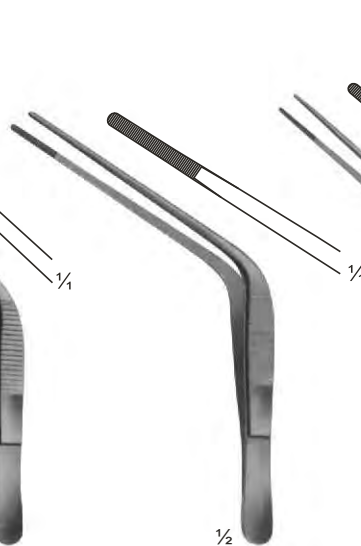

**04-242**  
WILDE  
115 mm

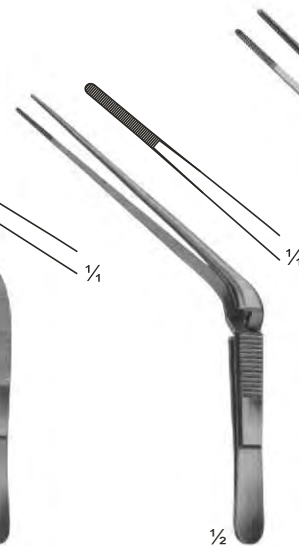

**04-243**  
TROELTSCH  
Cross action  
120 mm

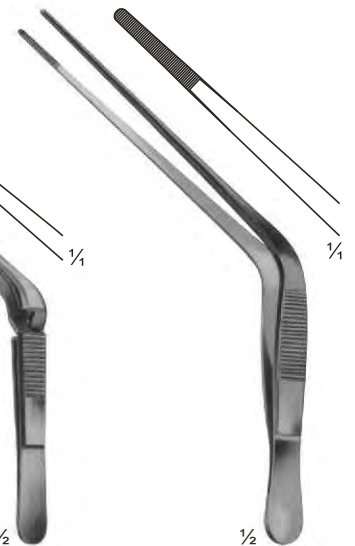

**04-244**  
TROELTSCH  
140 mm

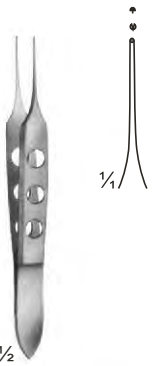

**04-245**  
BISHOP-HARMON  
85 mm

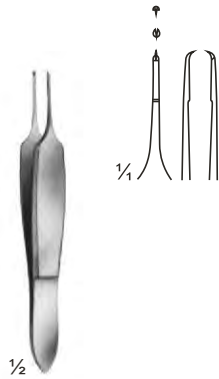

**04-246**  
ST.MARTIN  
80 mm

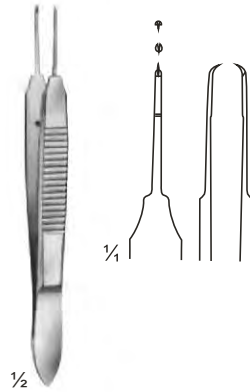

**04-247**  
CASTROVIEJO  
teeth 0.9 mm  
100 mm

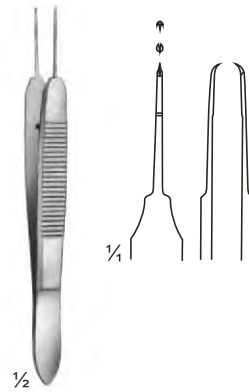

**04-248**  
CASTROVIEJO  
teeth 0.5 mm  
100 mm

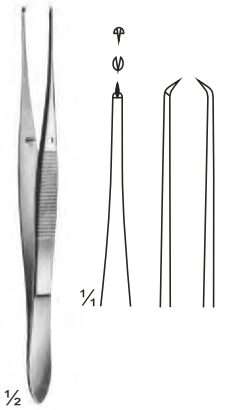

**04-249**  
ELSCHING  
110 mm

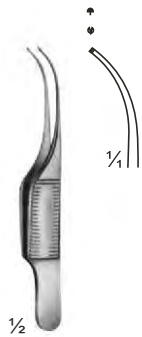

**04-250**  
GILL  
75 mm

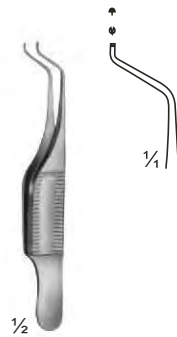

**04-251**  
GILL - HESS  
75 mm

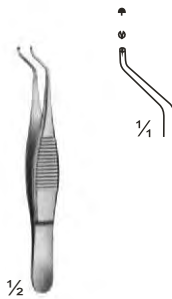

**04-252**  
HESS  
70 mm

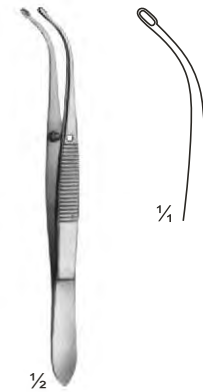

**04-253**  
ARRUGA  
100 mm

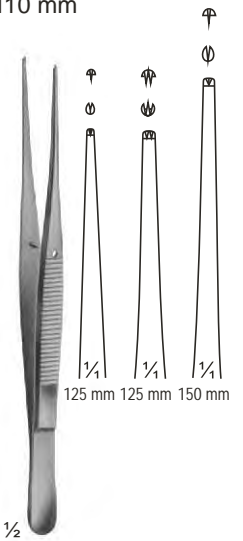

**04-254**  
SEMKEN

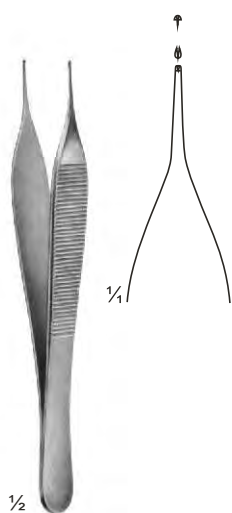

**04-255**  
MICRO-ADSON  
120 mm

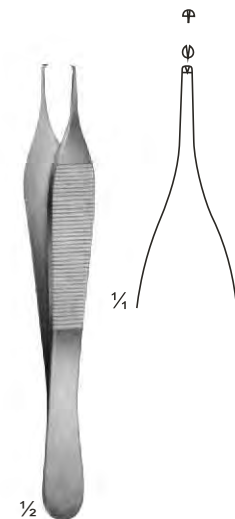

**04-256**  
ADSON  
120 mm

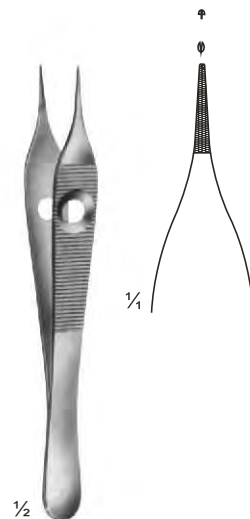

**04-257**  
ADSON  
120 mm



**04-258**  
ADSON  
120 mm

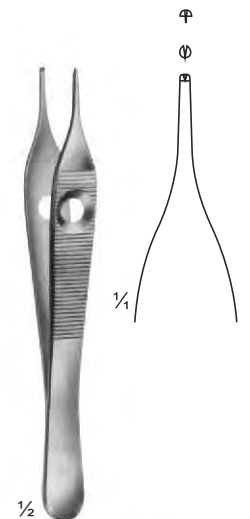

**04-259**  
ADSON  
150 mm

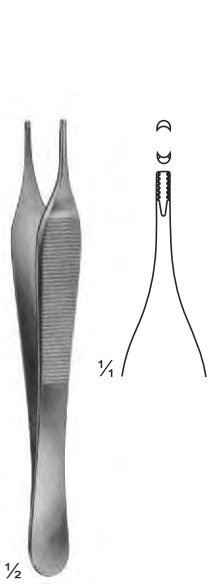

**04-260**  
**ADSON - BROWN**  
Non-traumatic  
120 mm

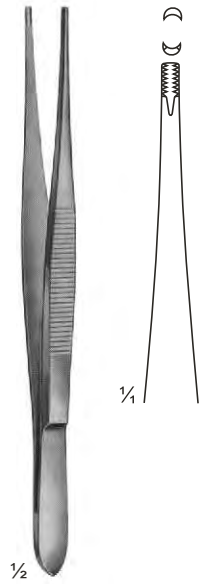

**04-261**  
**BROWN**  
120 mm

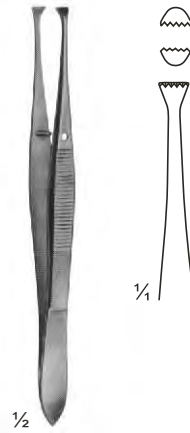

**04-262**  
**GRAEFE**  
110 mm

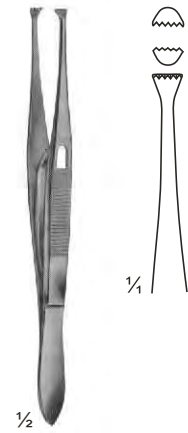

**04-263**  
**GRAEFE**  
With Catch  
110 mm

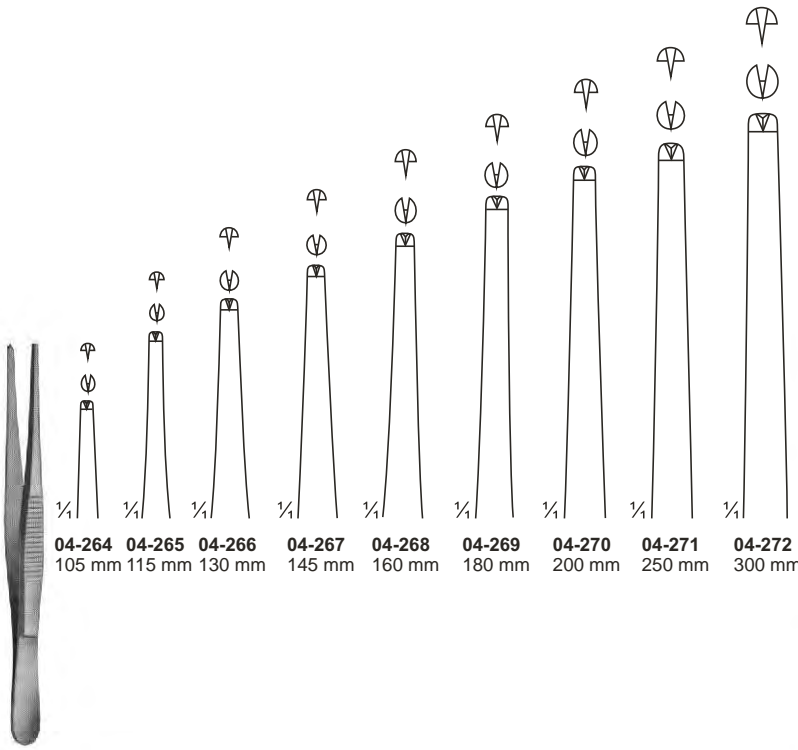

**04-264 - 272**  
**STANDARD**

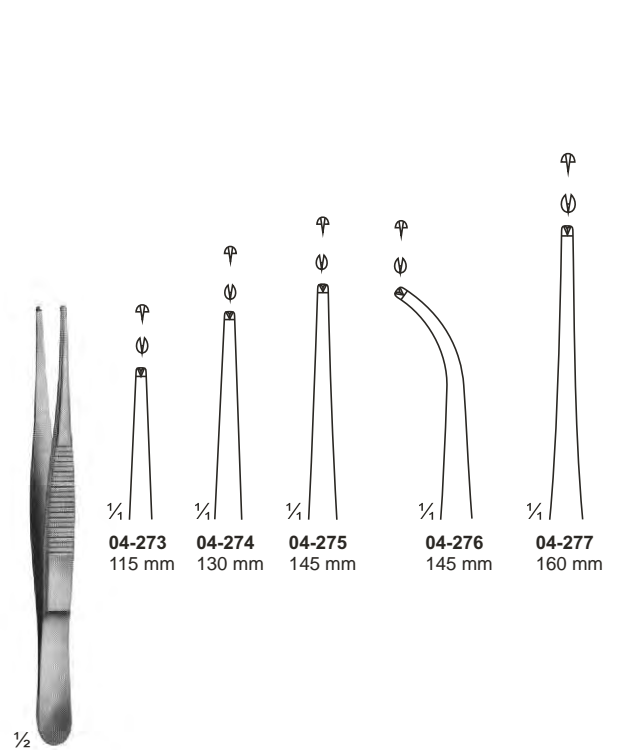

**04-273 - 277**  
**GRAEFE**  
110 mm

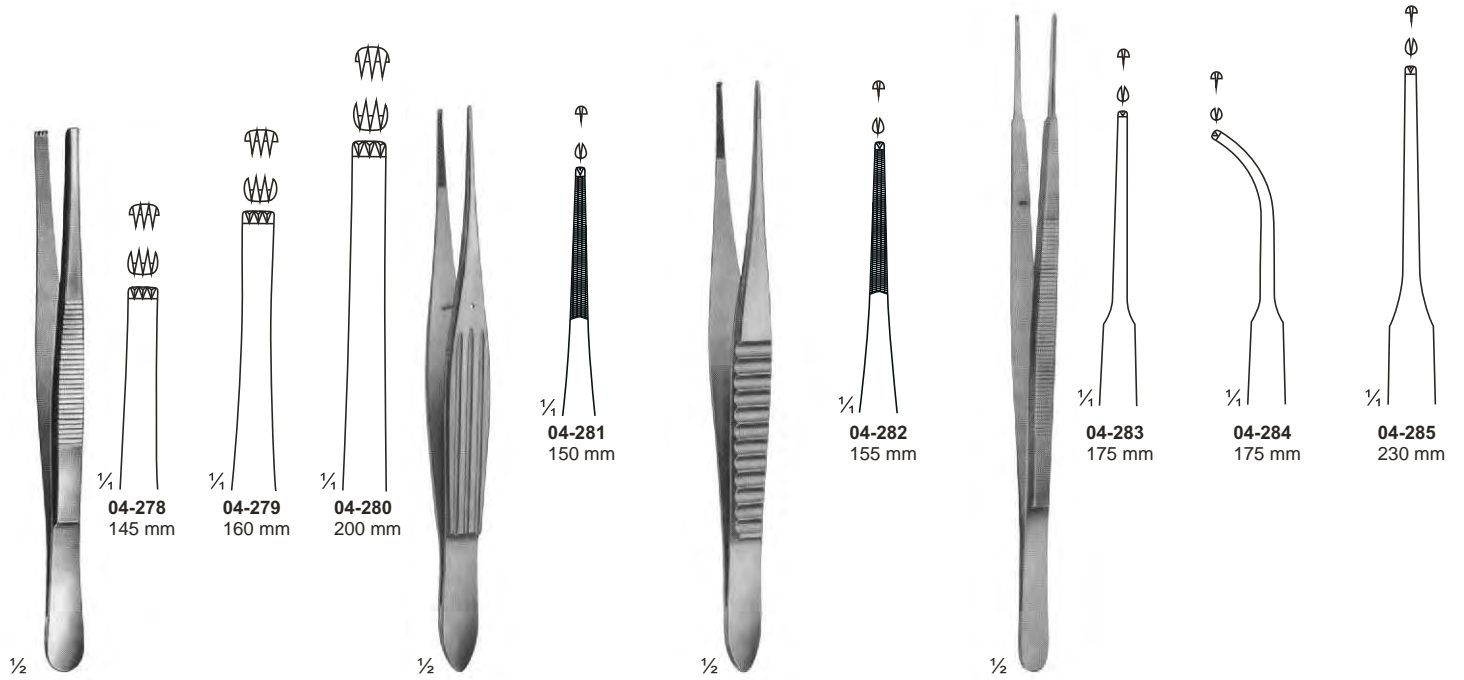

**04-278 - 280**  
3x4 teeth

**04-281**  
MC INDOE

**04-282**  
GILLIES

**04-283 - 285**  
GERALD

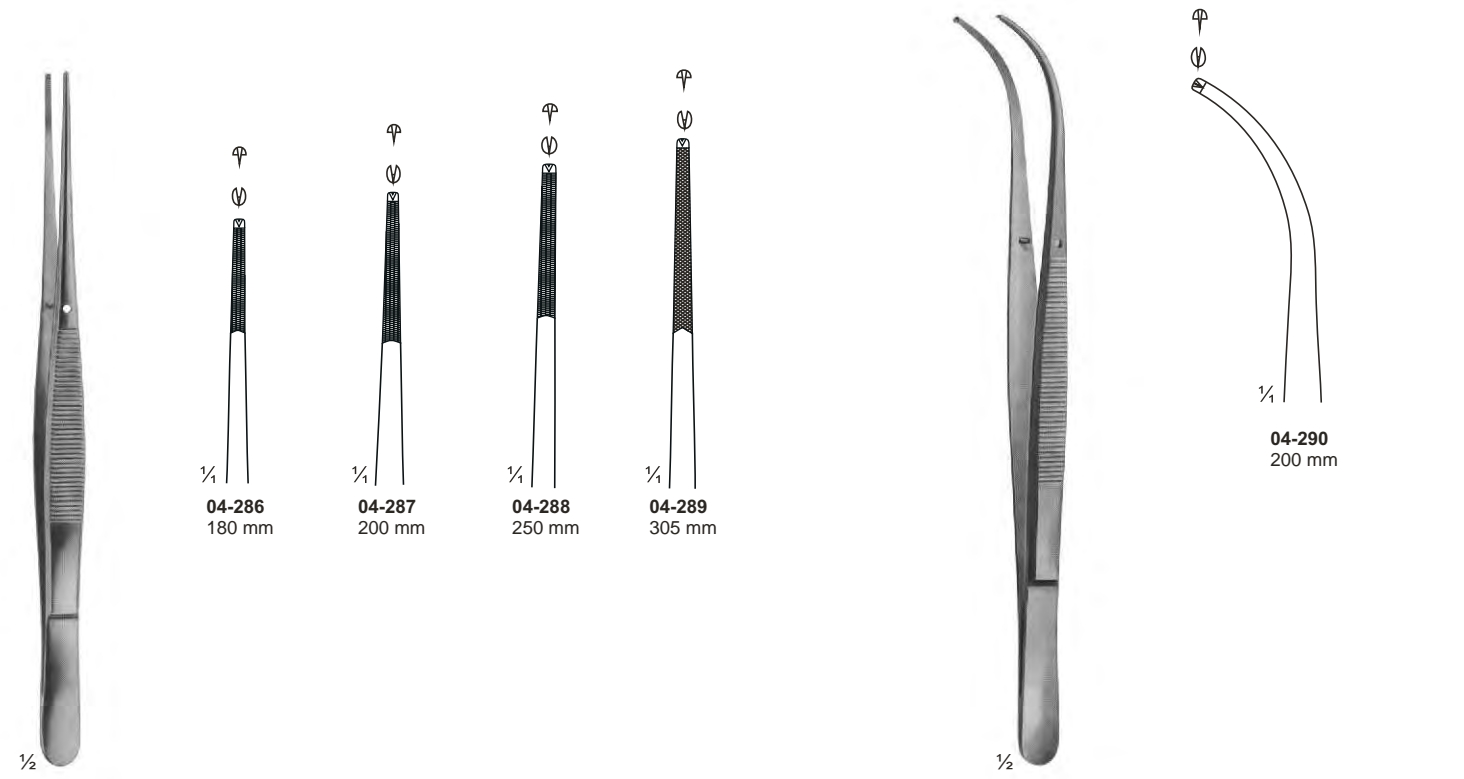

**04-286 - 289**  
WAUGH

**04-290**  
BROPHY

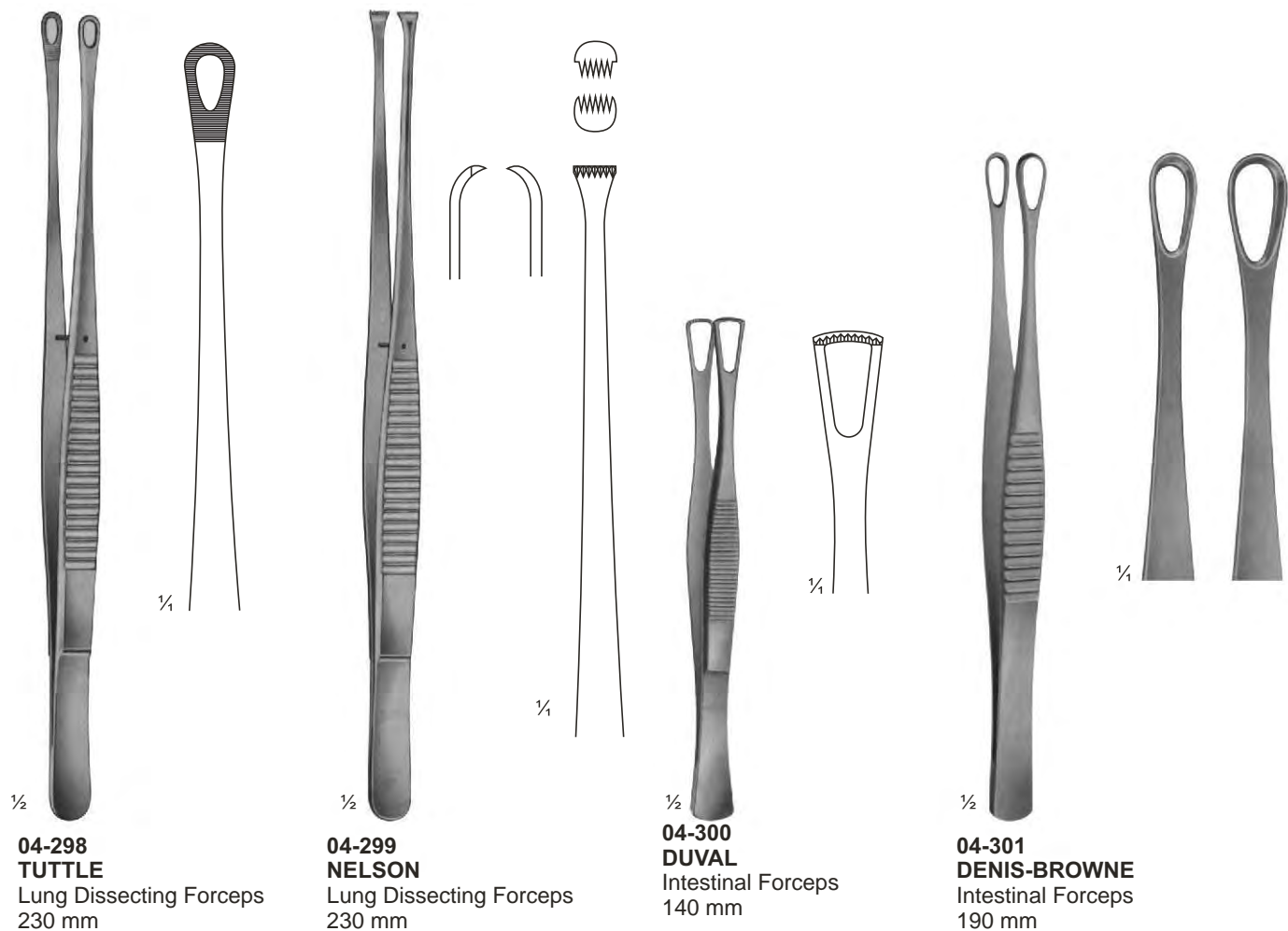
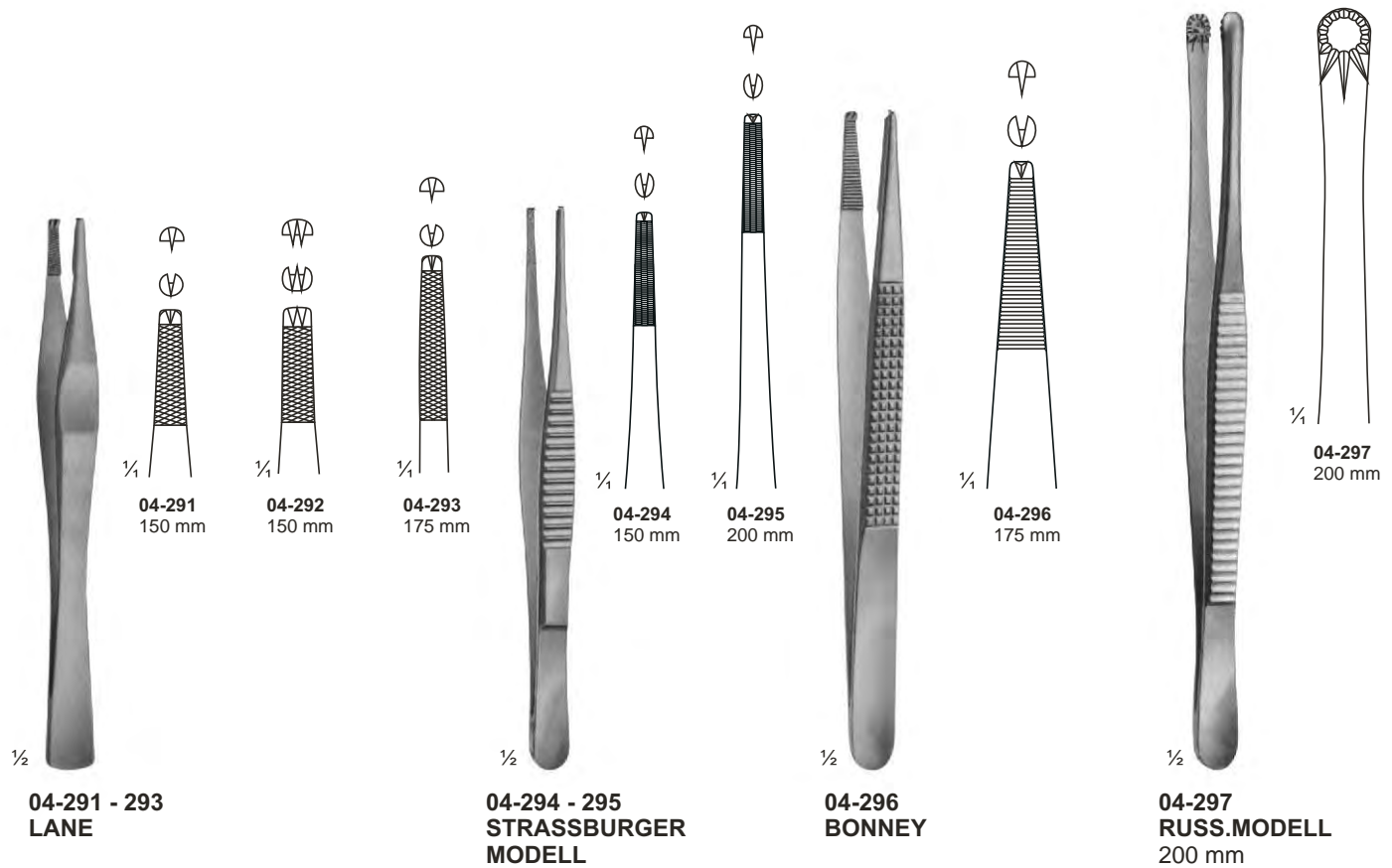

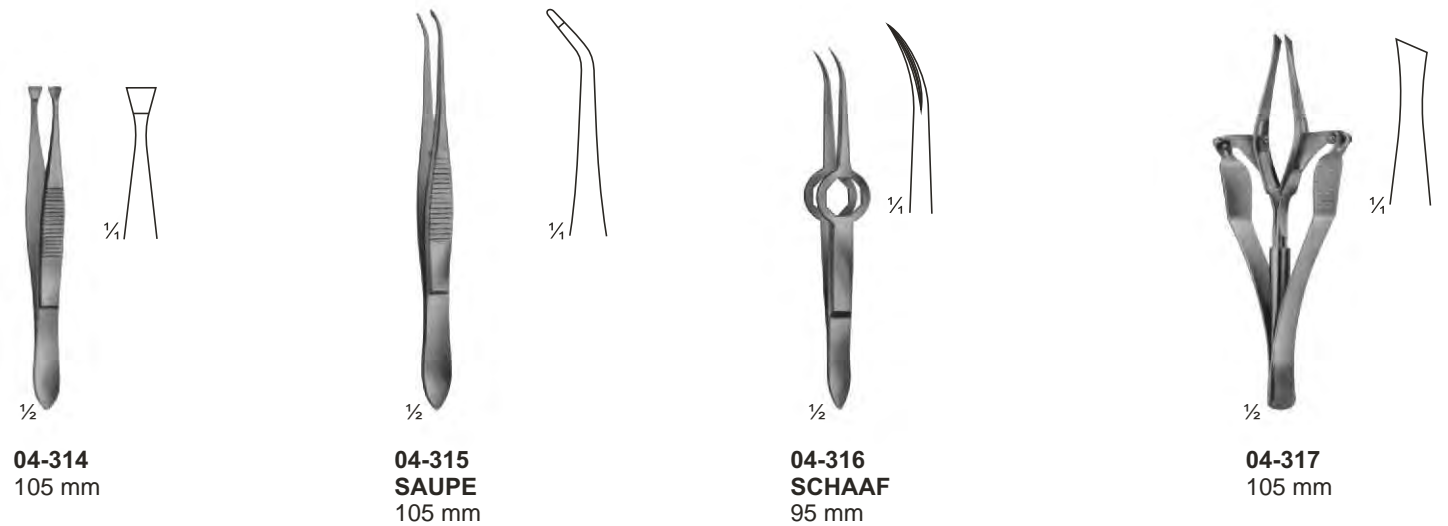
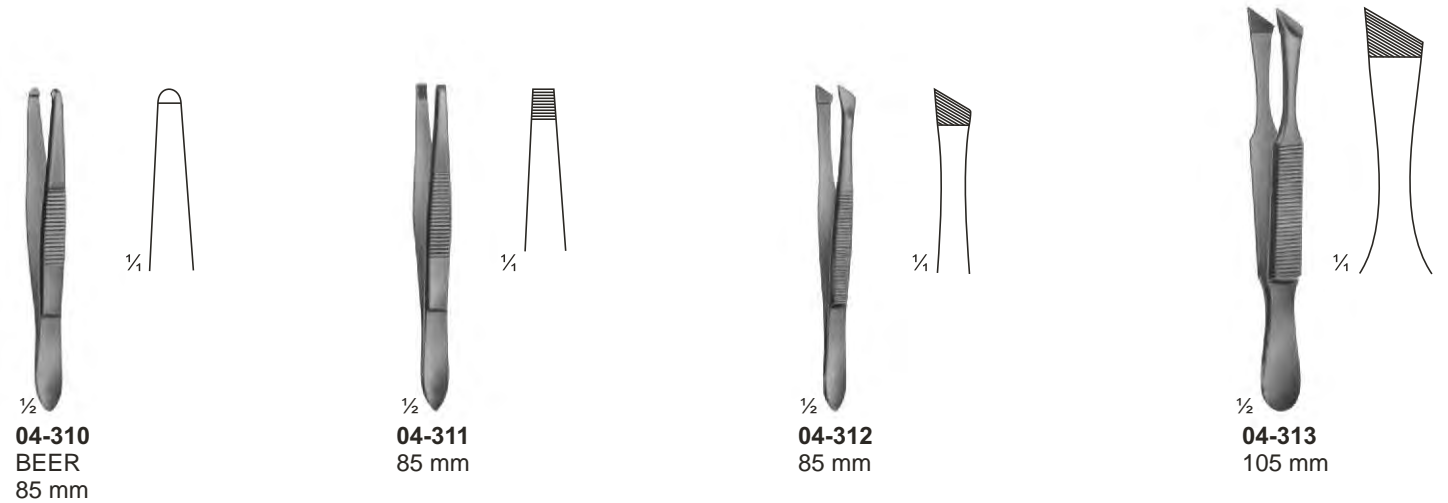
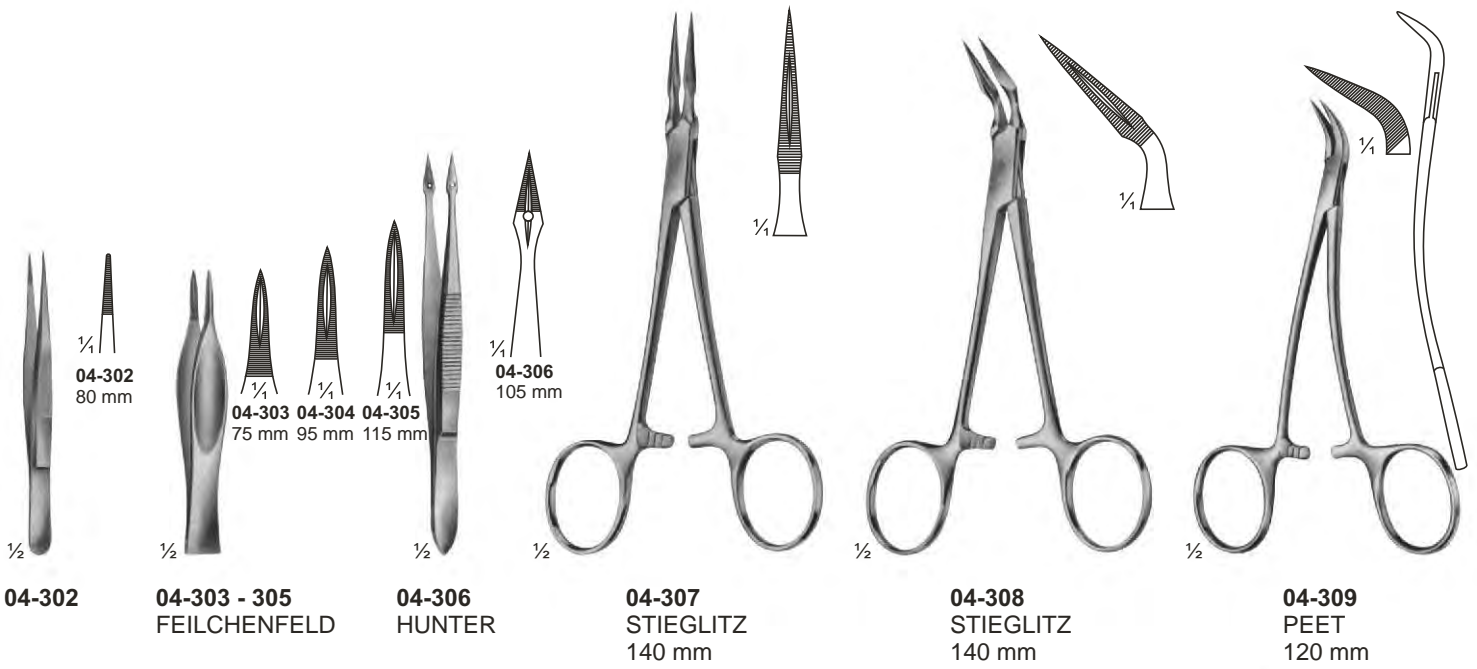

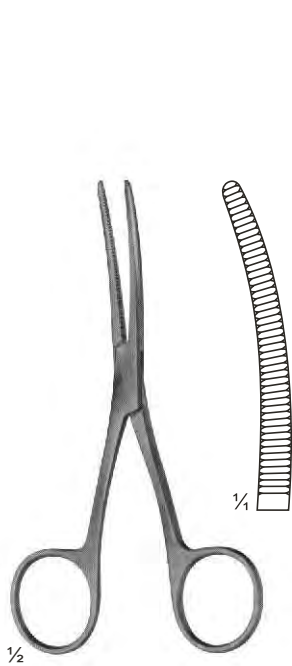

**04-318**  
BRYANT  
130 mm

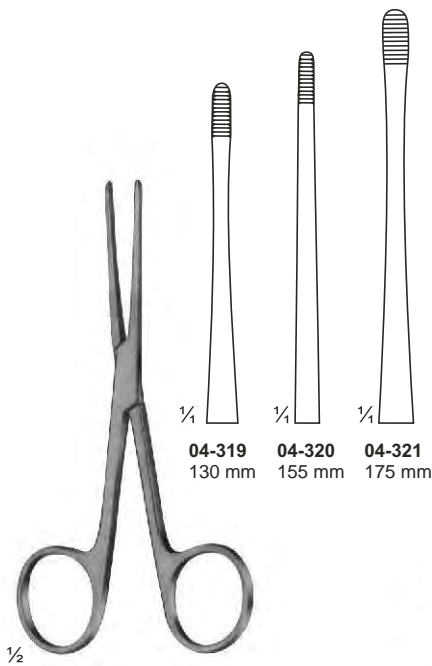

**04-319 - 321**  
LISTER  
Sinus Forceps

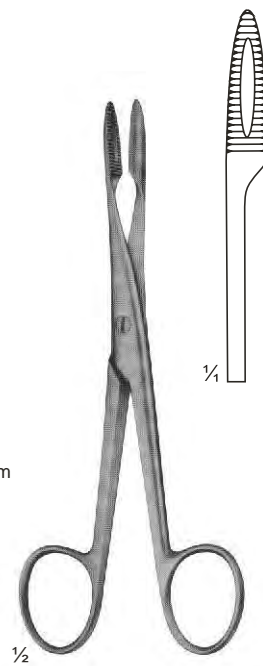

**04-322**  
Without Ratchet  
145 mm

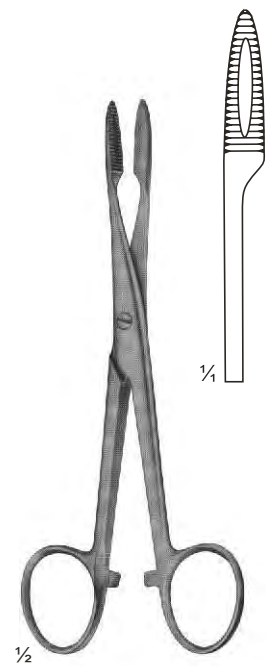

**04-323**  
With Ratchet  
145 mm

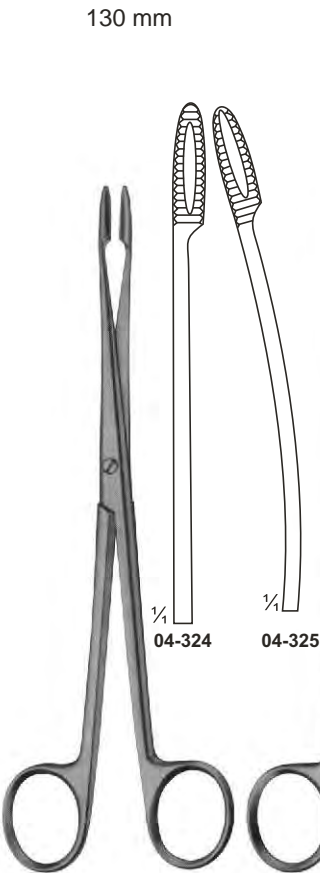

**04-324 - 325**  
GROSS  
Without Ratchet  
200 mm

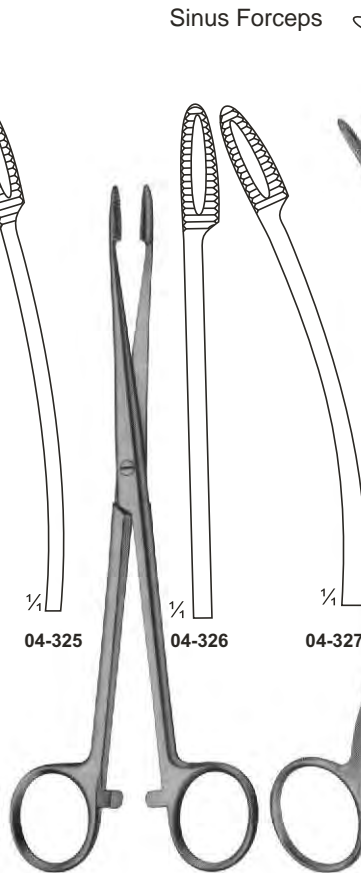

**04-326 - 327**  
GROSS  
With Ratchet  
180 mm

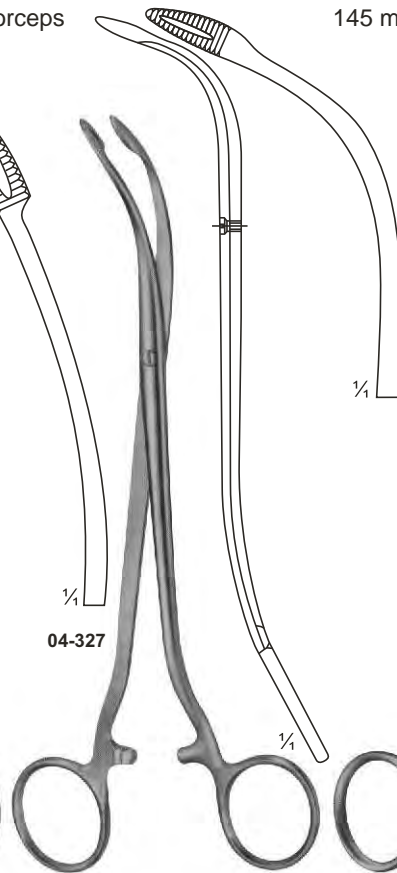

**04-328**  
DUPLAY  
190 mm

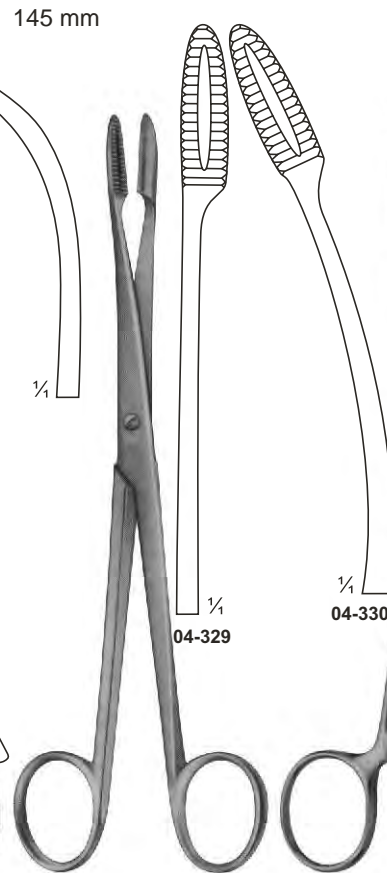

**04-329 - 330**  
GROSS  
Without Ratchet  
200 mm

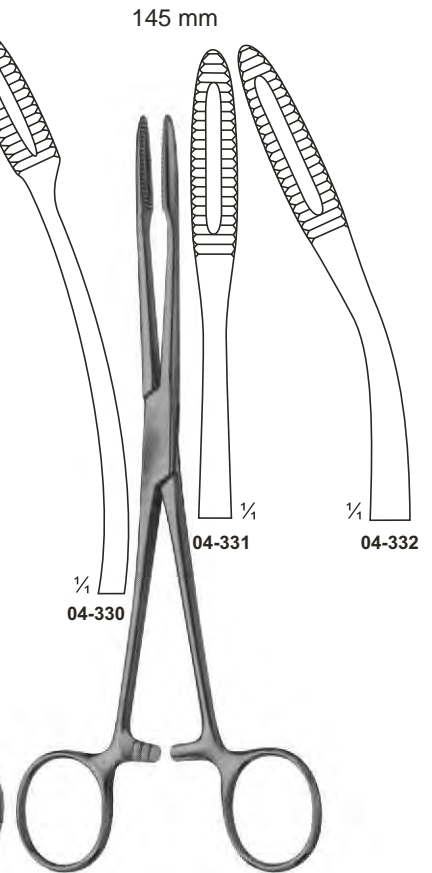

**04-331 - 332**  
GROSS  
With Ratchet  
200 mm

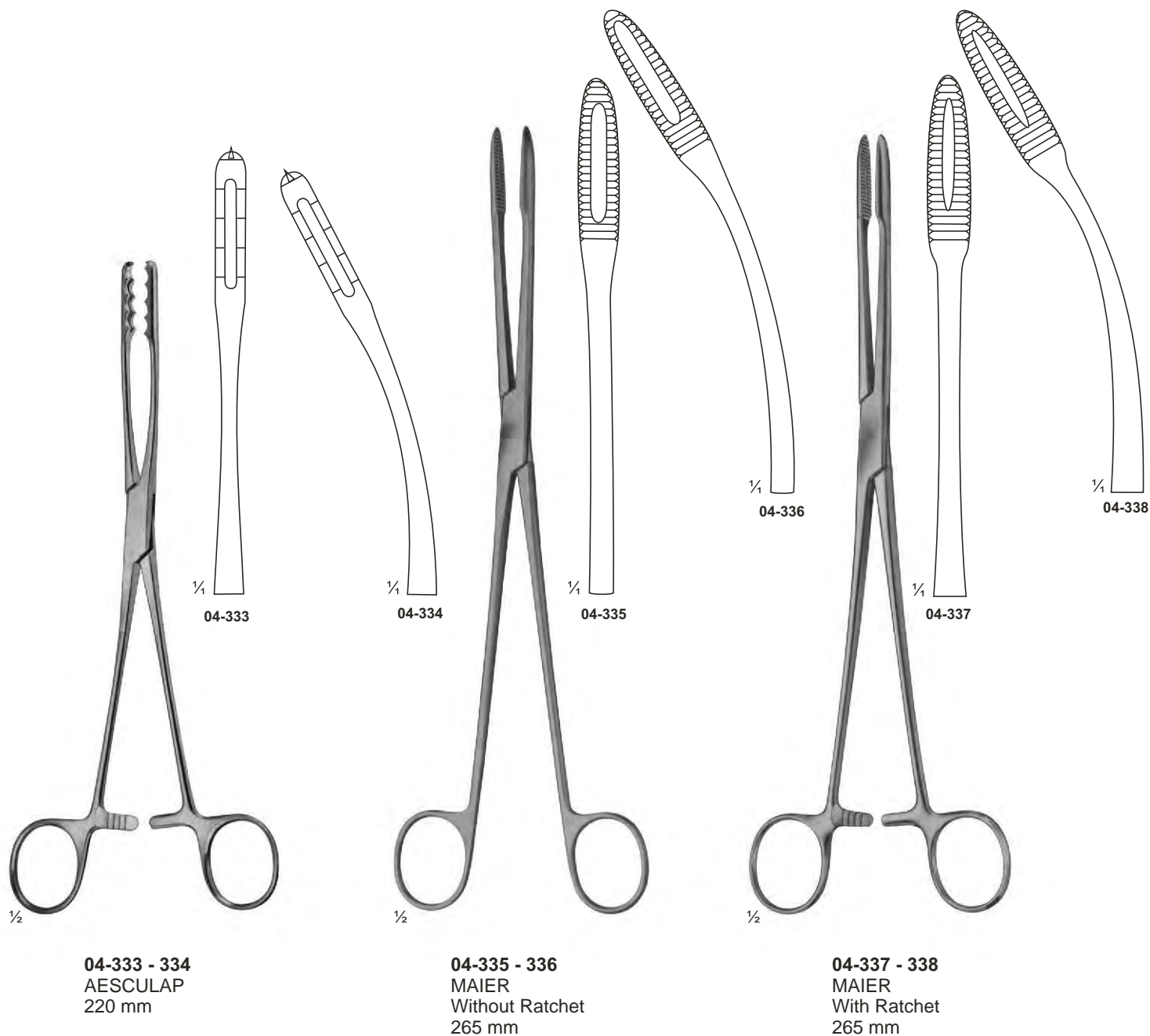

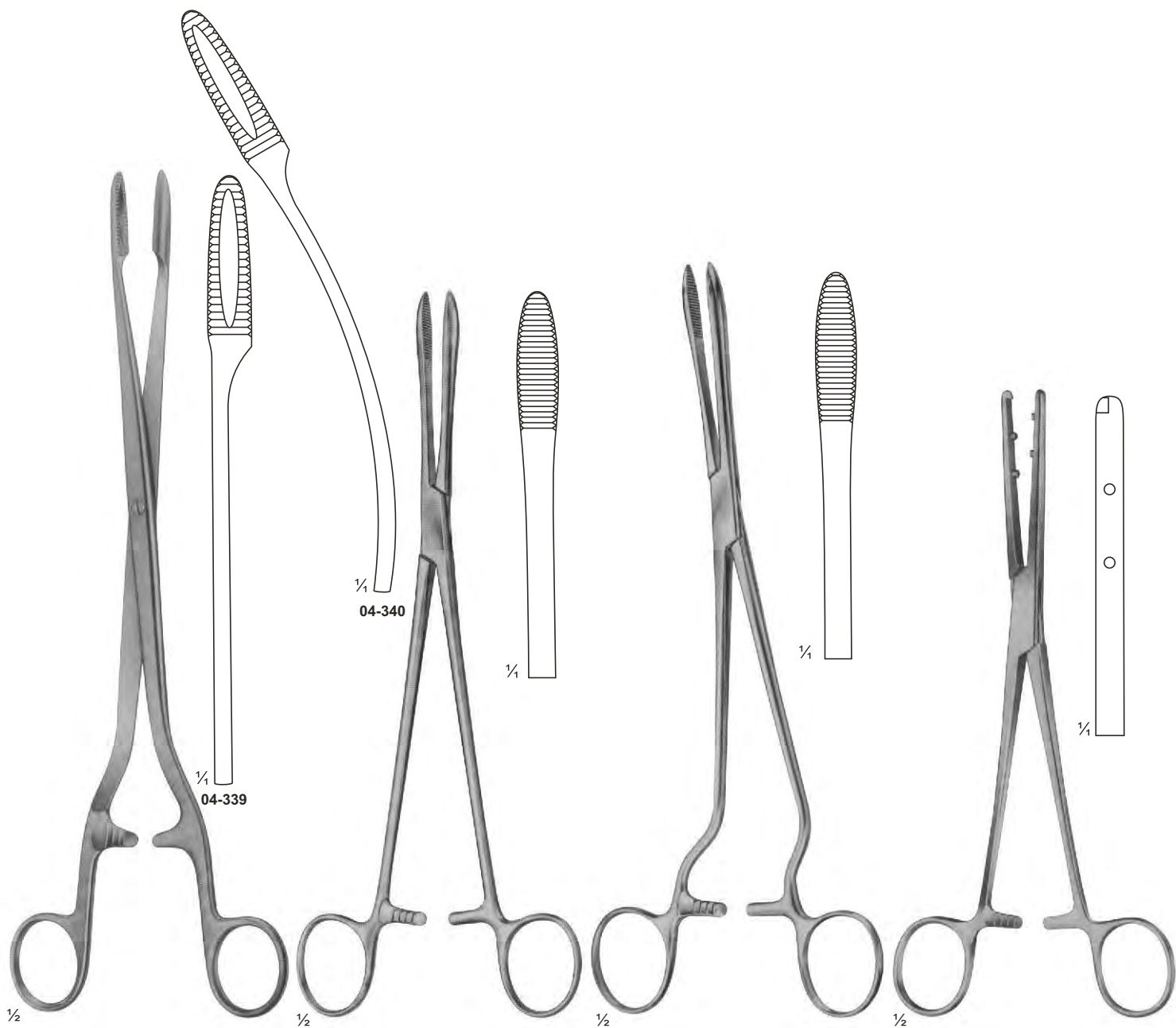

**04-339 - 340**  
SIMS-MAIER  
280 mm

**04-341**  
COLLIN  
240 mm

**04-342**  
CHERON  
Handles Laterally Angled  
240 mm

**04-343**  
EMMET  
210 mm

# Dressing, Sponge holding, Organ and Tissue Grasping Forceps

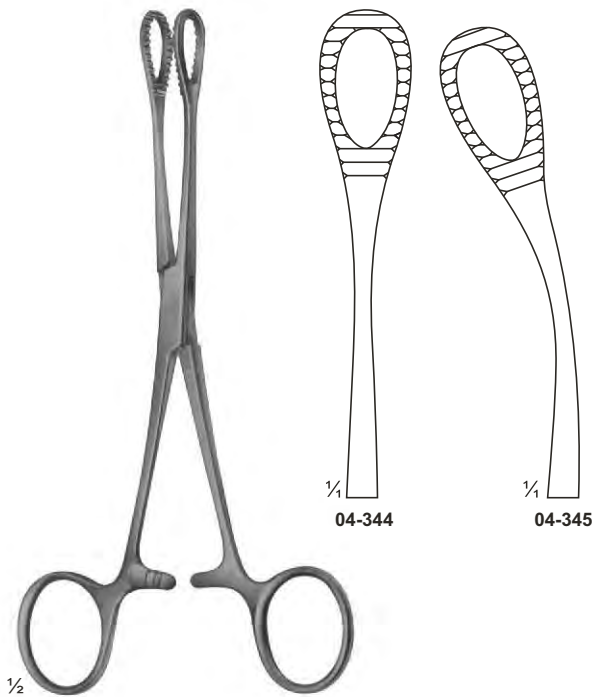

**04-344 - 345**  
FOERSTER-BALLENGER  
180 mm

**04-346 - 347**  
RAMPLEY

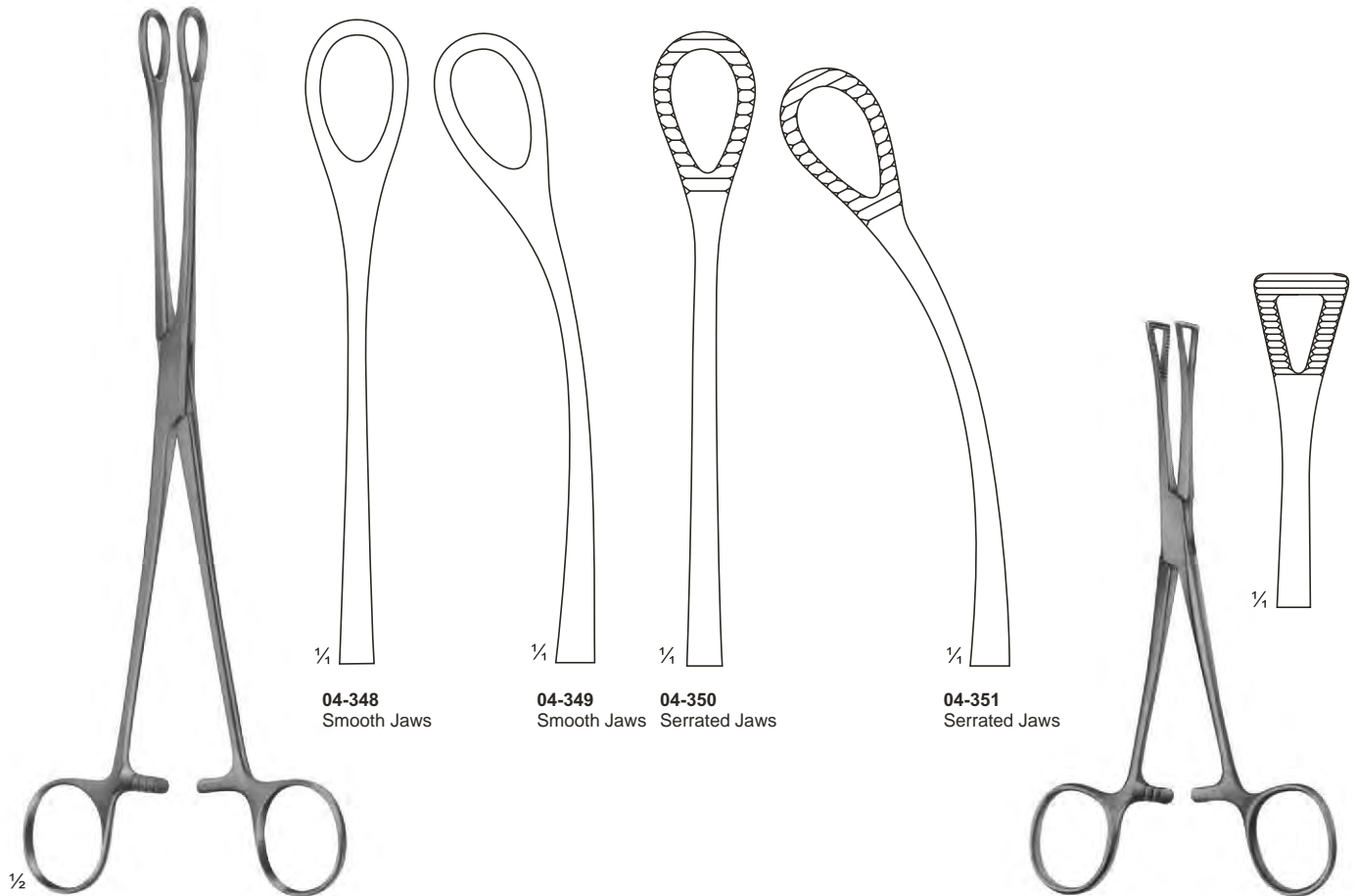

**04-348 - 351**  
FOERSTER-BALLENGER  
240 mm

**04-352**  
PENNINGTON  
155 mm

# Dressing, Sponge holding, Organ and Tissue Grasping Forceps

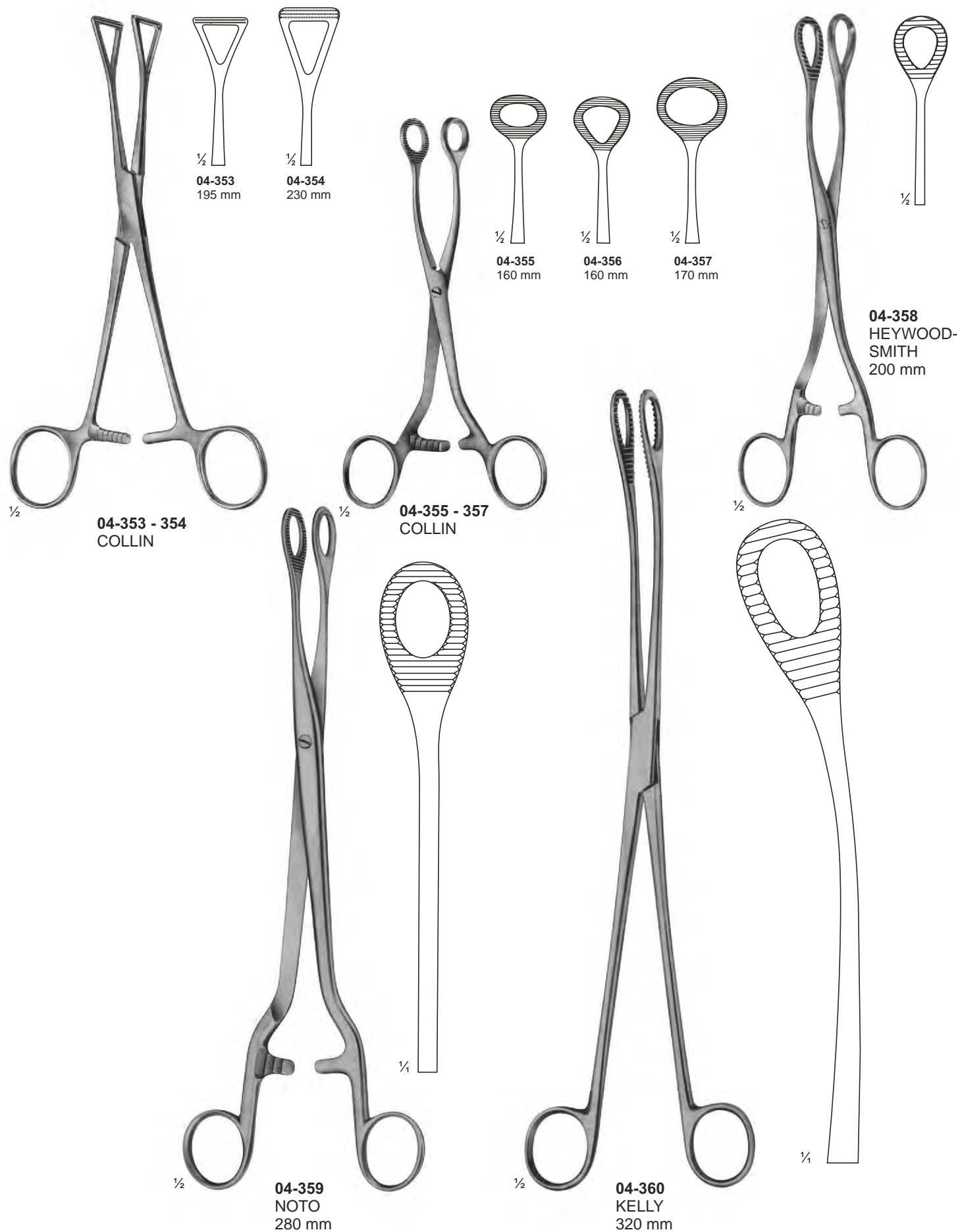

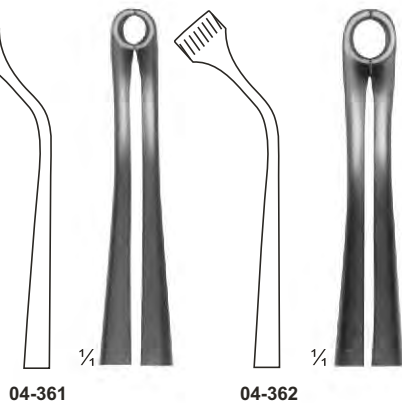
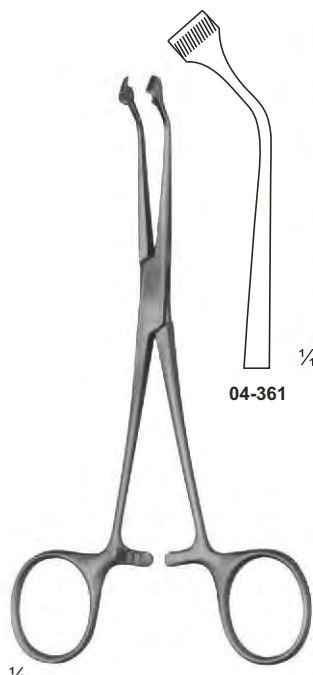

**04-361 - 362**  
HERZ  
155 mm

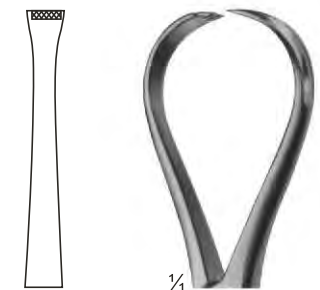

**04-363**  
JACKSON  
4 x 5 teeth  
150 mm

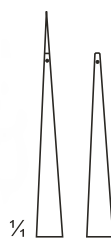
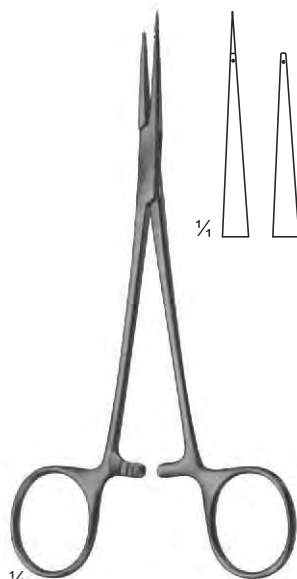

**04-364**  
150 mm

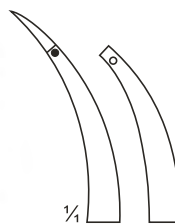
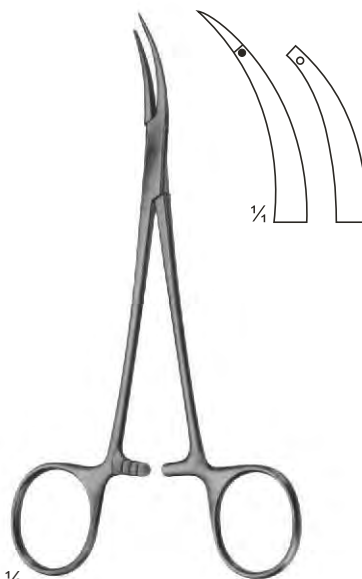

**04-365**  
150 mm

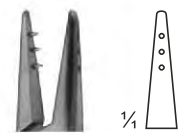

**04-366**  
120 mm

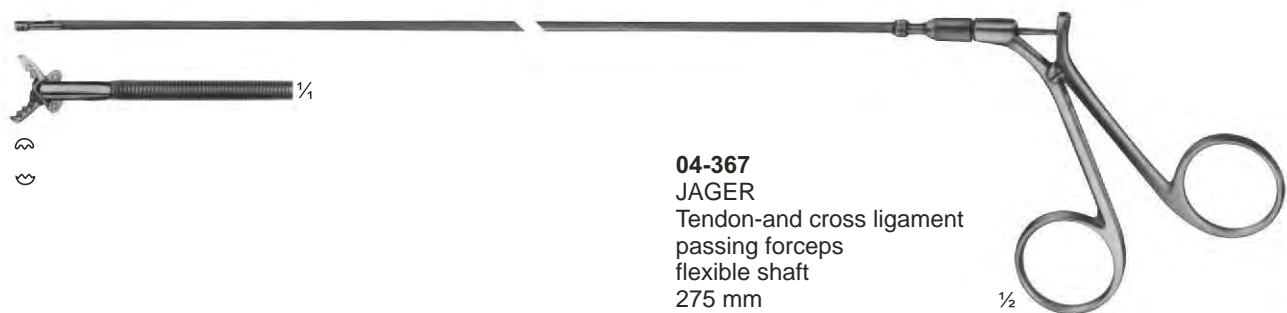

**04-367**  
JAGER  
Tendon-and cross ligament  
passing forceps  
flexible shaft  
275 mm

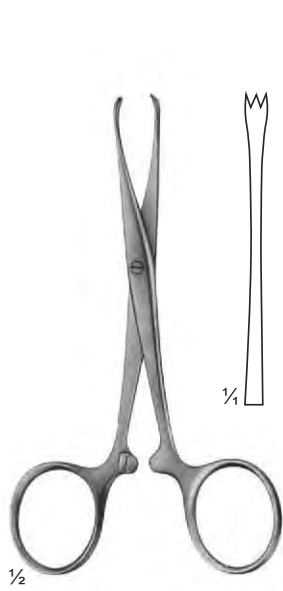

**04-368**  
**CHAPUT**  
 2 x 3 teeth  
 125 mm

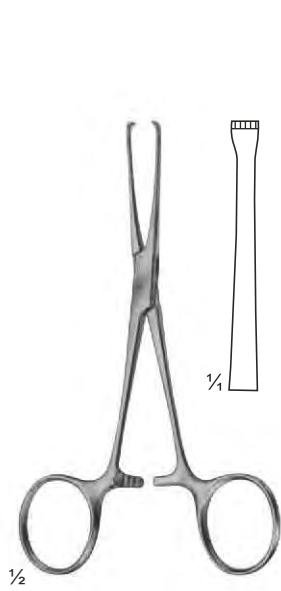

**04-369**  
**BABY-ALLIS**  
 4 x 5 teeth  
 130 mm

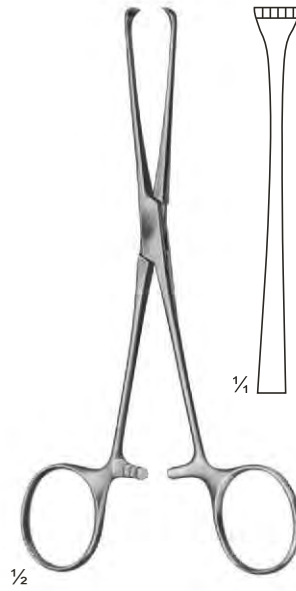

**04-370**  
**BOYS-ALLIS**  
 5 x 6 teeth  
 155 mm

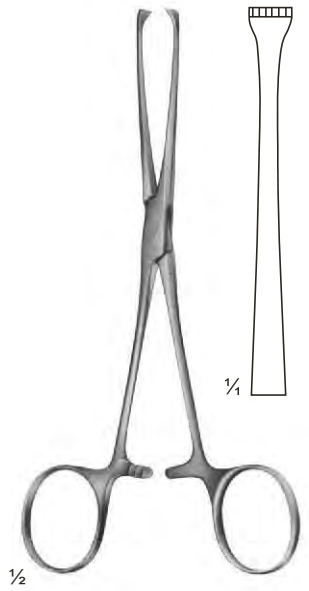

**04-371**  
**ALLIS**  
 5 x 6 teeth  
 155 mm

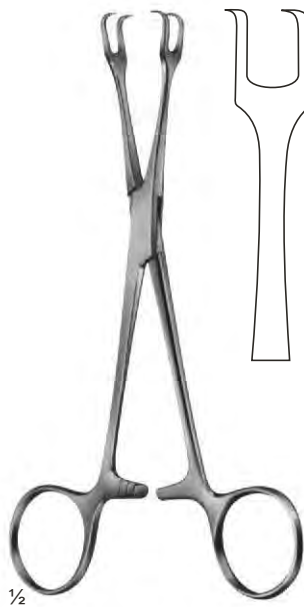

**04-372**  
**LAHEY**  
 135 mm

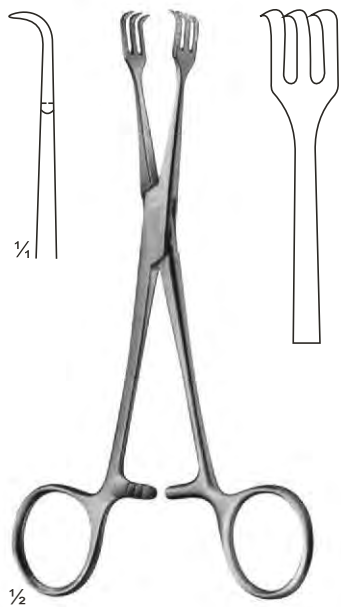

**04-373**  
**LAHEY**  
 135 mm

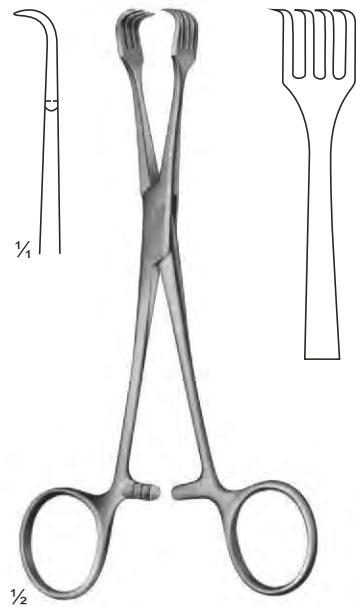

**04-374**  
**BRAUN**  
 155 mm

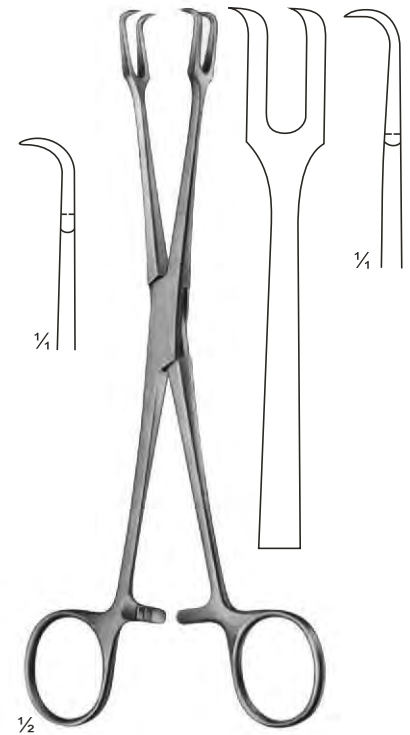

**04-375**  
**MUSEUX**  
 200 mm

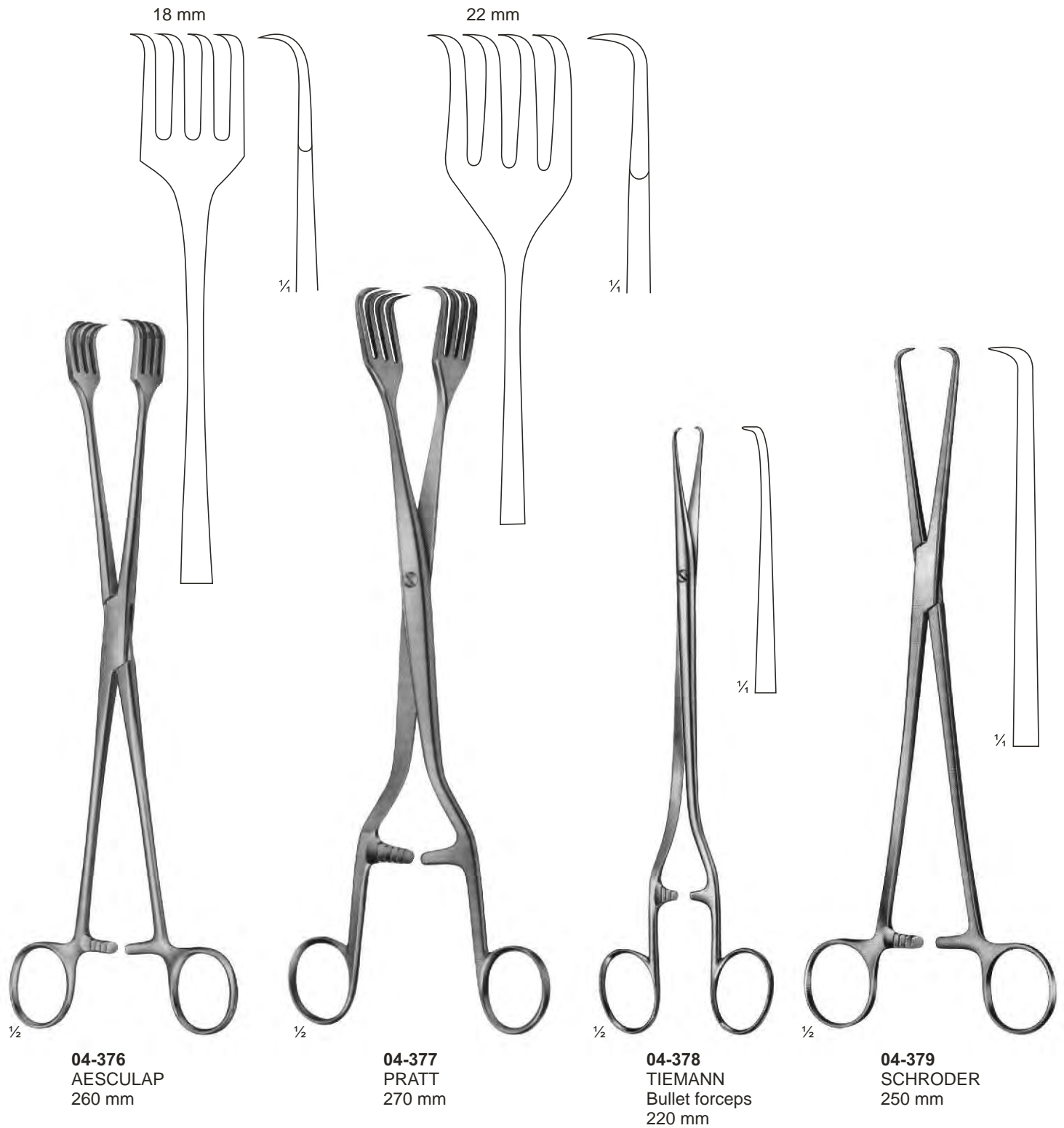

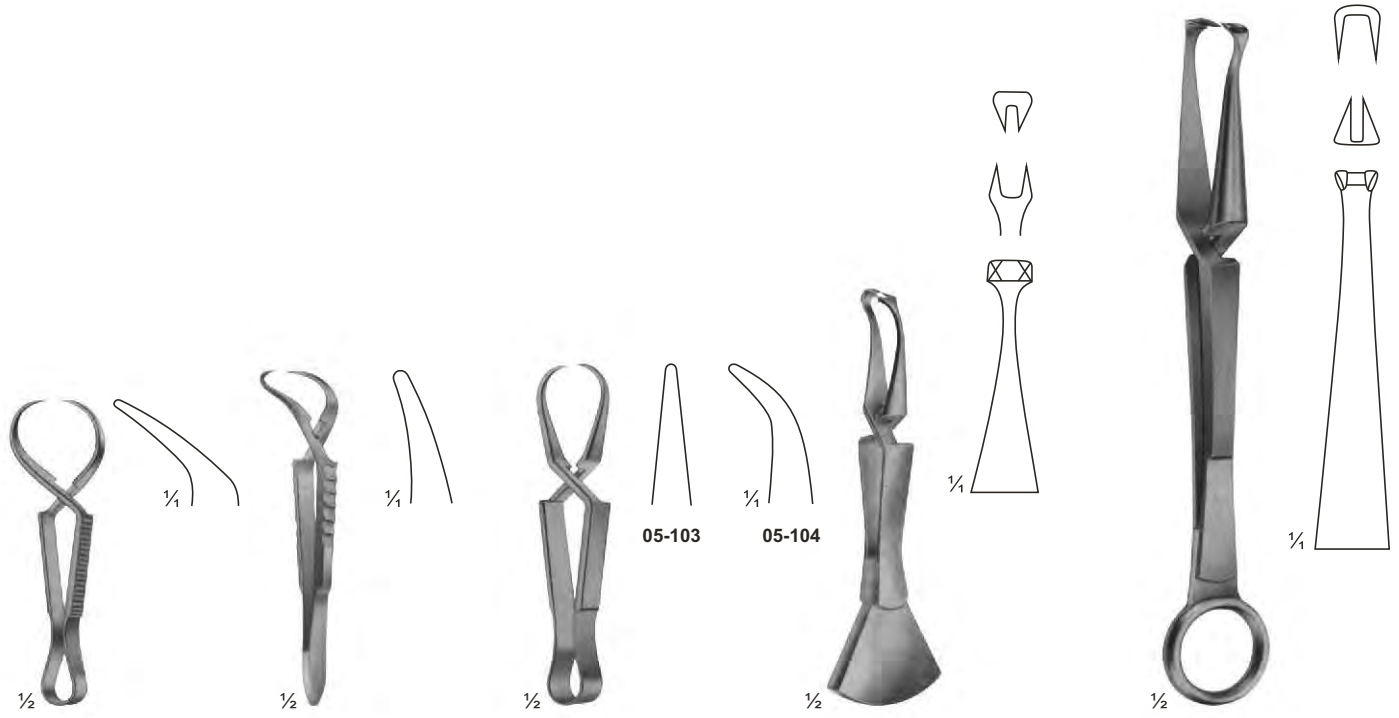

**05-101**  
JONES  
85 mm

**05-102**  
ENGL. MOD.  
85 mm

**05-103 - 104**  
SCHAEDEL  
85 mm

**05-105**  
DOYEN  
110 mm

**05-106**  
DOYEN  
180 mm

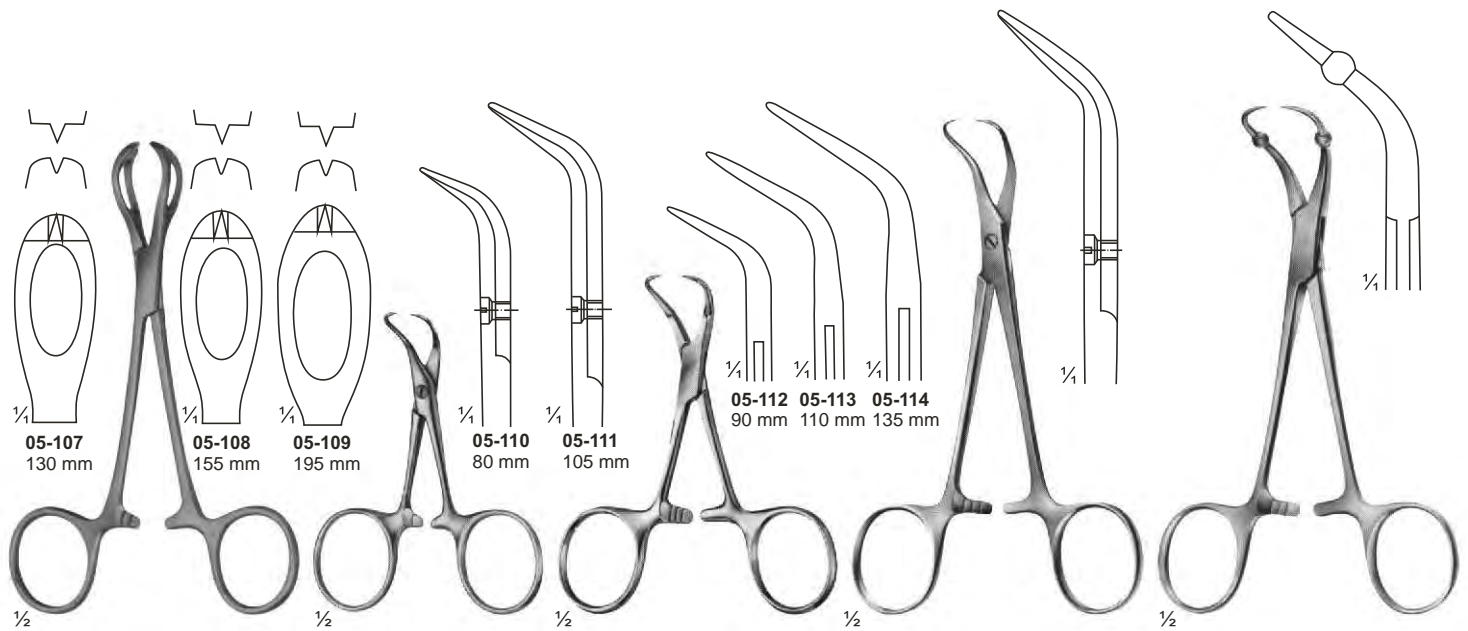

**05-107**  
130 mm

**05-108**  
155 mm

**05-109**  
195 mm

**05-110**  
80 mm

**05-111**  
105 mm

**05-112 05-113 05-114**  
90 mm 110 mm 135 mm

**05-107 - 109**  
LANE

**05-110 - 111**  
BACKHAUS

**05-112 - 114**  
BACKHAUS

**05-115**  
BACKHAUS-KOCHER  
135 mm

**05-116**  
ROEDER  
135 mm

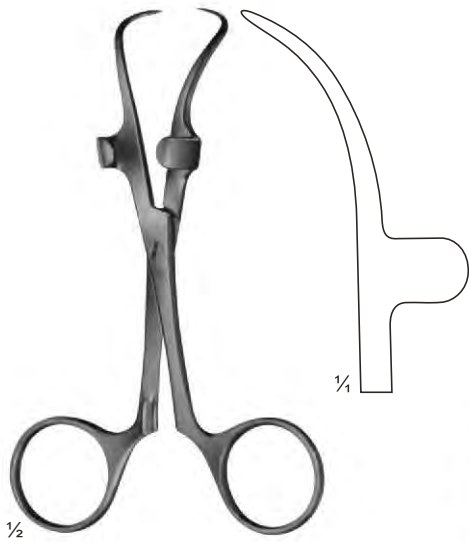

**05-117**  
**ROBIN**  
 with holders for tubing  
 up to 13 mm  
 135 mm

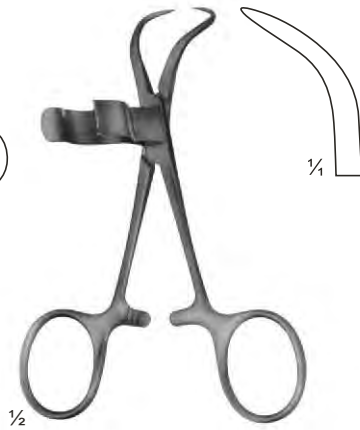

**05-118**  
 with clip for tubing  
 up to 15 mm  
 110 mm

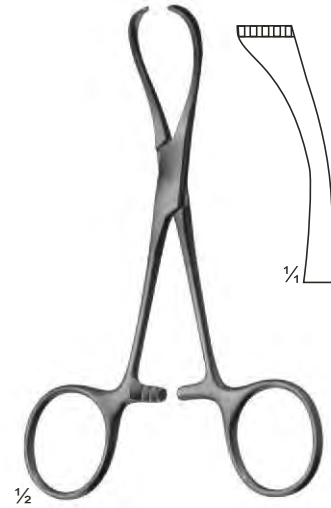

**05-119**  
**LORNA**  
 non perforating  
 130 mm

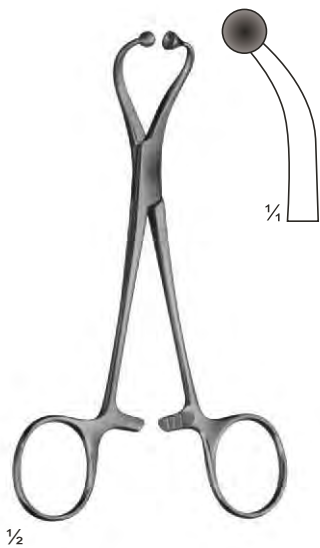

**05-120**  
 for paper cloths  
 140 mm









**05-121**  
**BUNT**  
 105 mm













**05-122**  
**MAYO**  
 140 mm













## Closing force

						
<b>05-123</b> Straight	<b>05-124</b> Curved	<b>05-125</b> Curved tips	<b>05-126</b> Angled Shaped	<b>05-127</b> Muller Knee-bent	<b>05-128</b> Muller Ligature Forceps	Jaw, cross serrated
80g 50g	80g 50g	80g 50g	80g 50g	80g 50g	80g 50g	

									
<b>05-129</b> 35 mm	<b>05-130</b> 35 mm	<b>05-131</b> 45 mm	<b>05-132</b> 45 mm	<b>05-133</b> <b>05-134</b> 38 mm 48 mm	<b>05-135</b> <b>05-136</b> 38 mm 48 mm	<b>05-137</b> 58 mm	<b>05-138</b> 58 mm	<b>05-139 - 145</b> 38 mm 48 mm 56 mm 63 mm 70 mm 80 mm 90 mm	<b>05-146</b> DE BAKEY- HESS 20 mm

									
<b>05-147</b> Length 50 mm Jaws 27 mm	<b>05-148</b> Length 48 mm Jaws 27 mm	<b>05-149</b> GLOVER Length 57 mm Jaws 35 mm	<b>05-150</b> DE BAKEY Length 73 mm Jaws 38 mm	<b>05-151</b> DE BAKEY Length 99 mm Jaws 63 mm	<b>05-152</b> DE BAKEY Length 95 mm Jaws 54 mm	<b>05-153</b> L. 80 mm <b>05-154</b> L. 90 mm <b>05-155</b> L. 105 mm <b>05-156</b> L. 124 mm	<b>05-157</b> L. 78 mm <b>05-158</b> L. 86 mm <b>05-159</b> L. 97 mm <b>05-160</b> L. 114 mm	<b>05-161</b> GLOVER L. 68 mm <b>05-162</b> L. 96 mm <b>05-163</b> L. 117 mm	<b>05-164</b> GLOVER L. 65 mm <b>05-165</b> L. 91 mm <b>05-166</b> L. 110 mm



**06-101**  
CARREL  
85 mm



**06-102 - 105**  
BABY-MOSQUITO  
(HARTMANN)  
100 mm



1/4  
06-102

1/4  
06-103

1/4  
06-104

1/4  
06-105

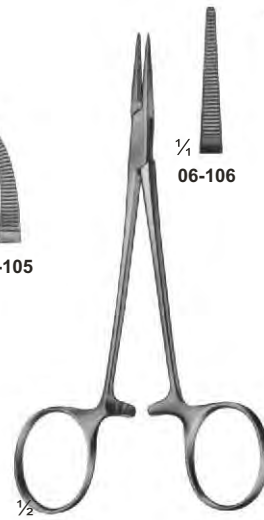

**06-106 - 109**  
MICRO-HALSTED  
125 mm



1/4  
06-106

1/4  
06-107

1/4  
06-108

1/4  
06-109



**06-110 - 113**  
HALSTED-MOSQUITO  
125 mm

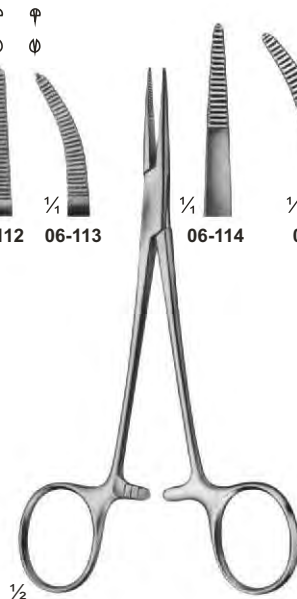

**06-114 - 115**  
PROVIDENCE-HOSPITAL  
140 mm



1/4  
06-114

1/4  
06-115

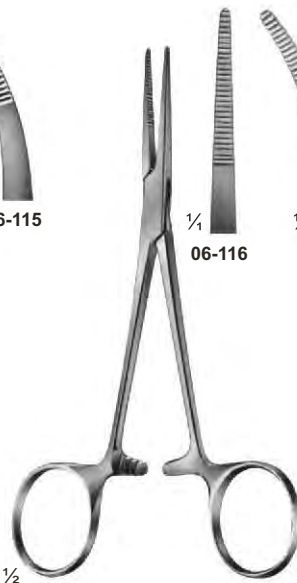

**06-116 - 117**  
KELLY  
140 mm

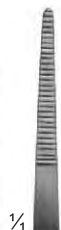

1/4  
06-116

1/4  
06-117

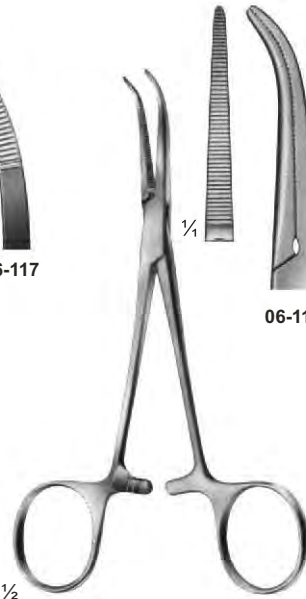

**06-118 - 119**  
DANDY  
Curved sideways  
140 mm



1/4  
06-118



1/4  
06-119

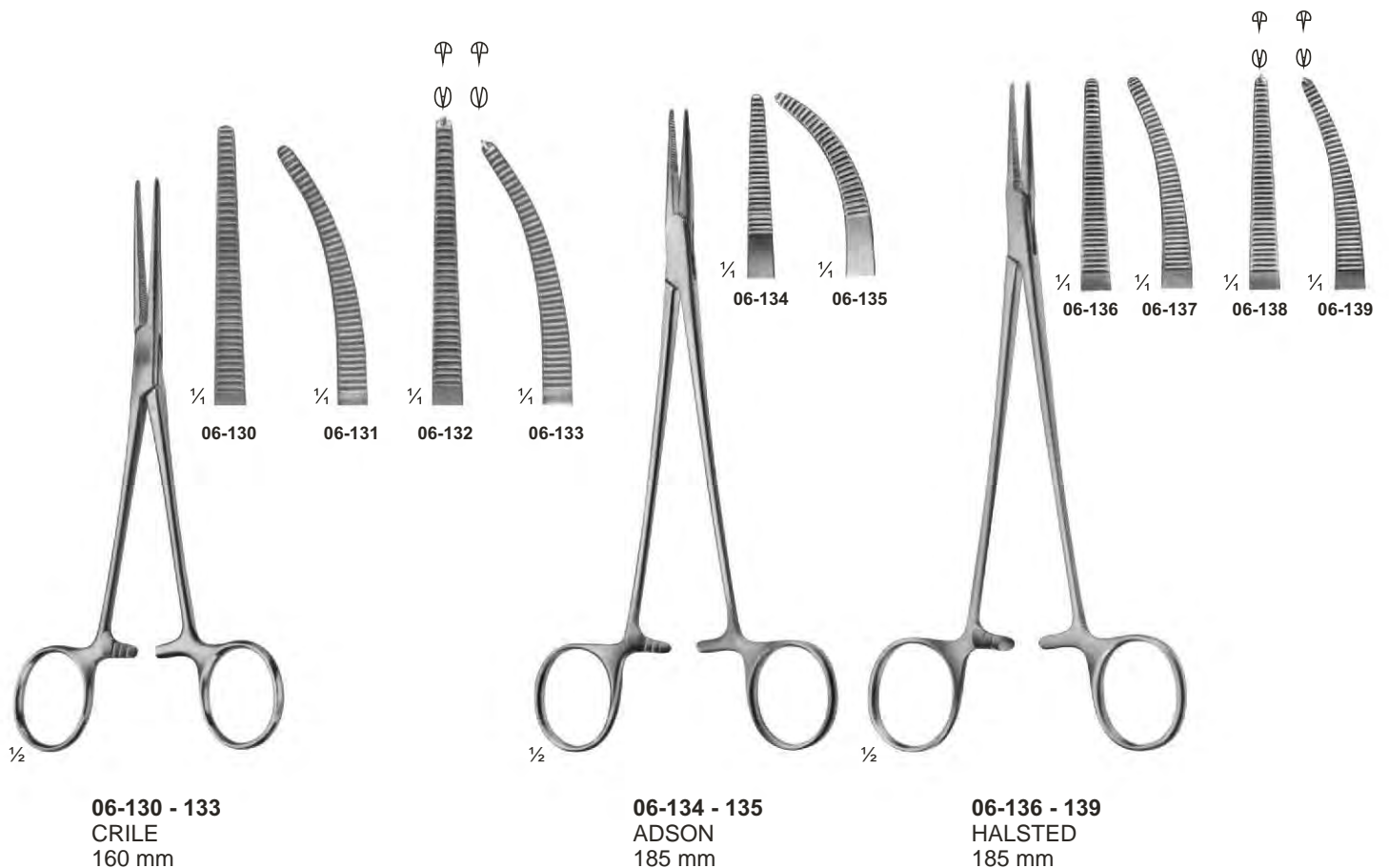
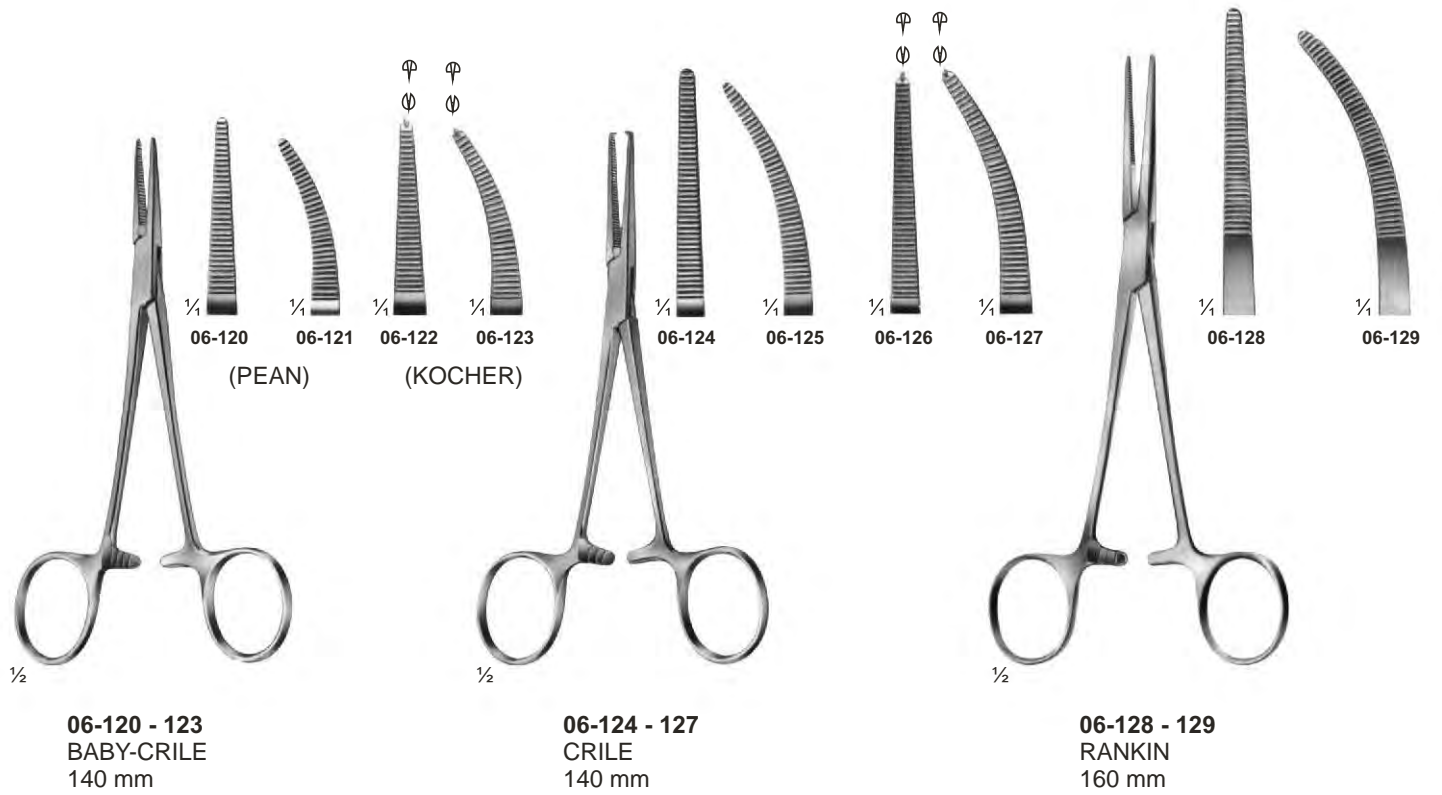

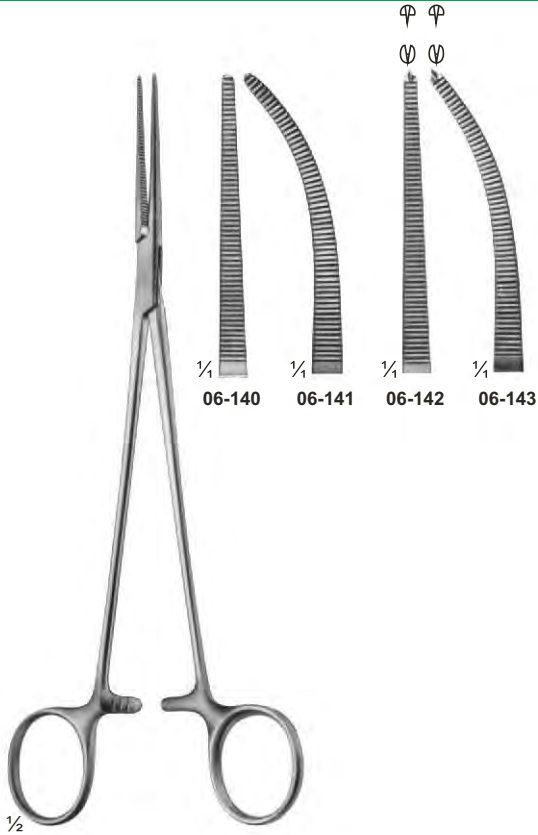

**06-140 - 143**  
HALSTED-MOSQUITO  
200 mm

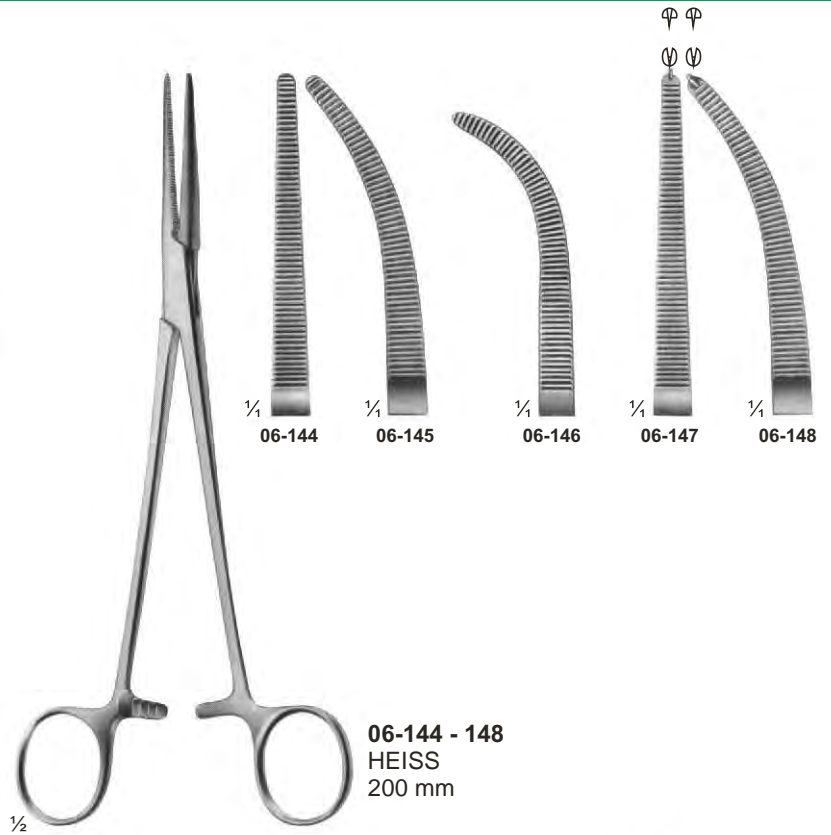

**06-144 - 148**  
HEISS  
200 mm

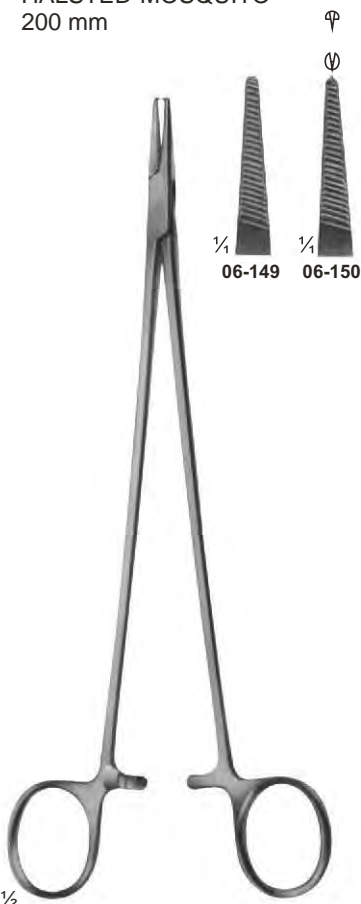

**06-149 - 150**  
HALSTED  
215 mm

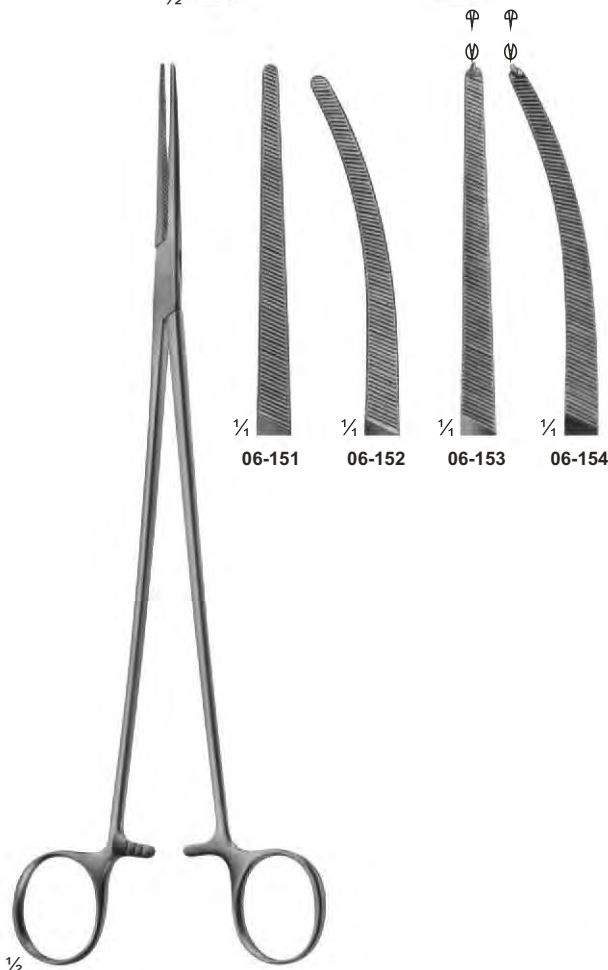

**06-151 - 154**  
BENGOLEA  
245 mm

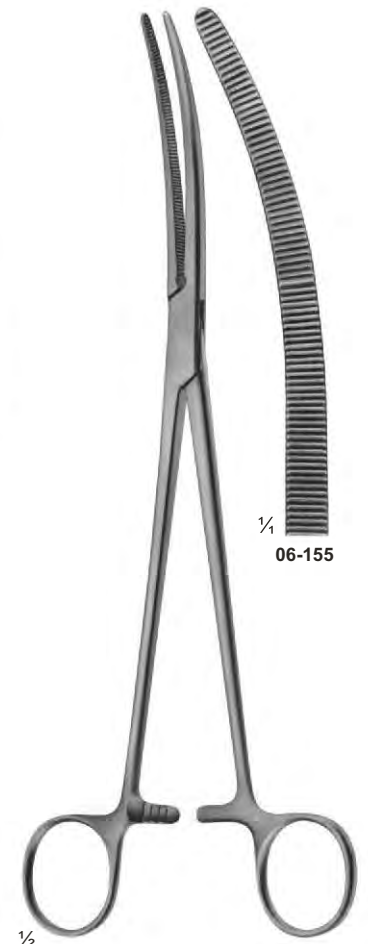

**06-155**  
CRAFOORD  
245 mm

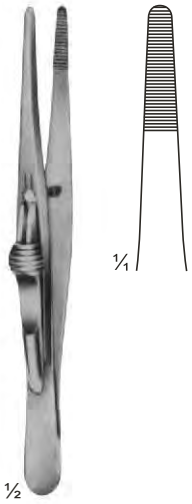

**06-156**  
FRICKE  
Artery forceps  
130 mm

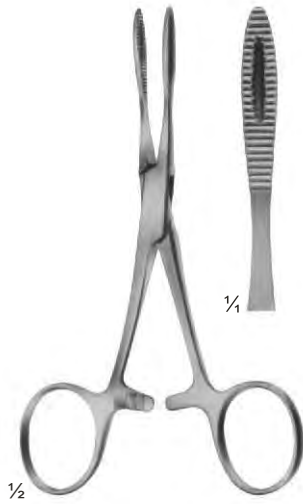

**06-157**  
KRONLEIN  
130 mm

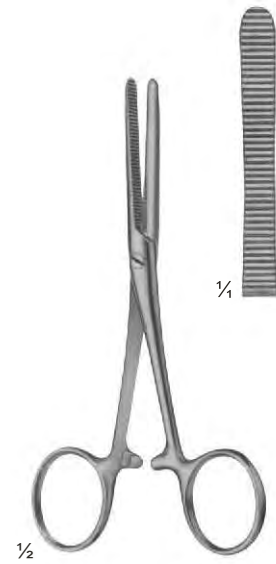

**06-158**  
PEAN  
125 mm

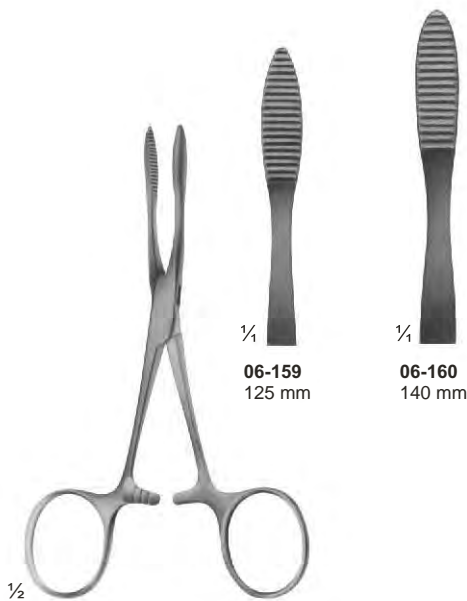

**06-159 - 160**  
PEAN

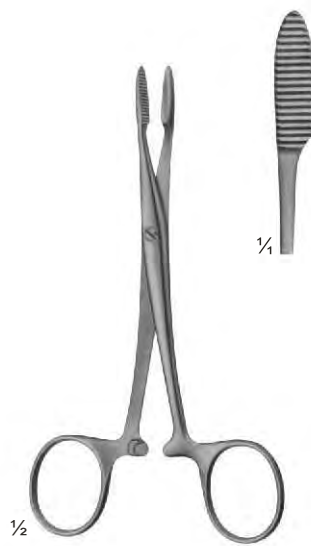

**06-161**  
PEAN

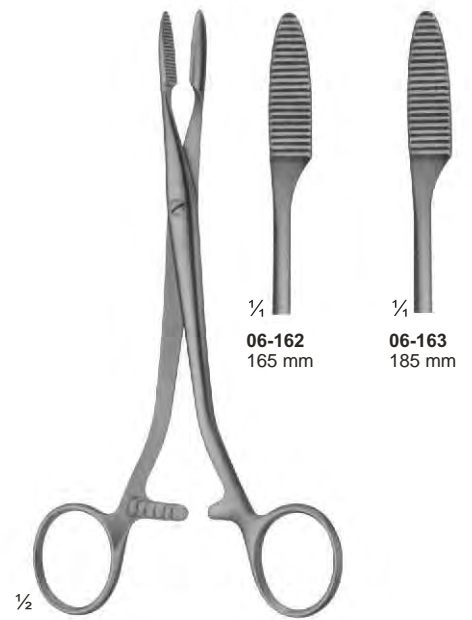

**06-162 - 163**  
PEAN

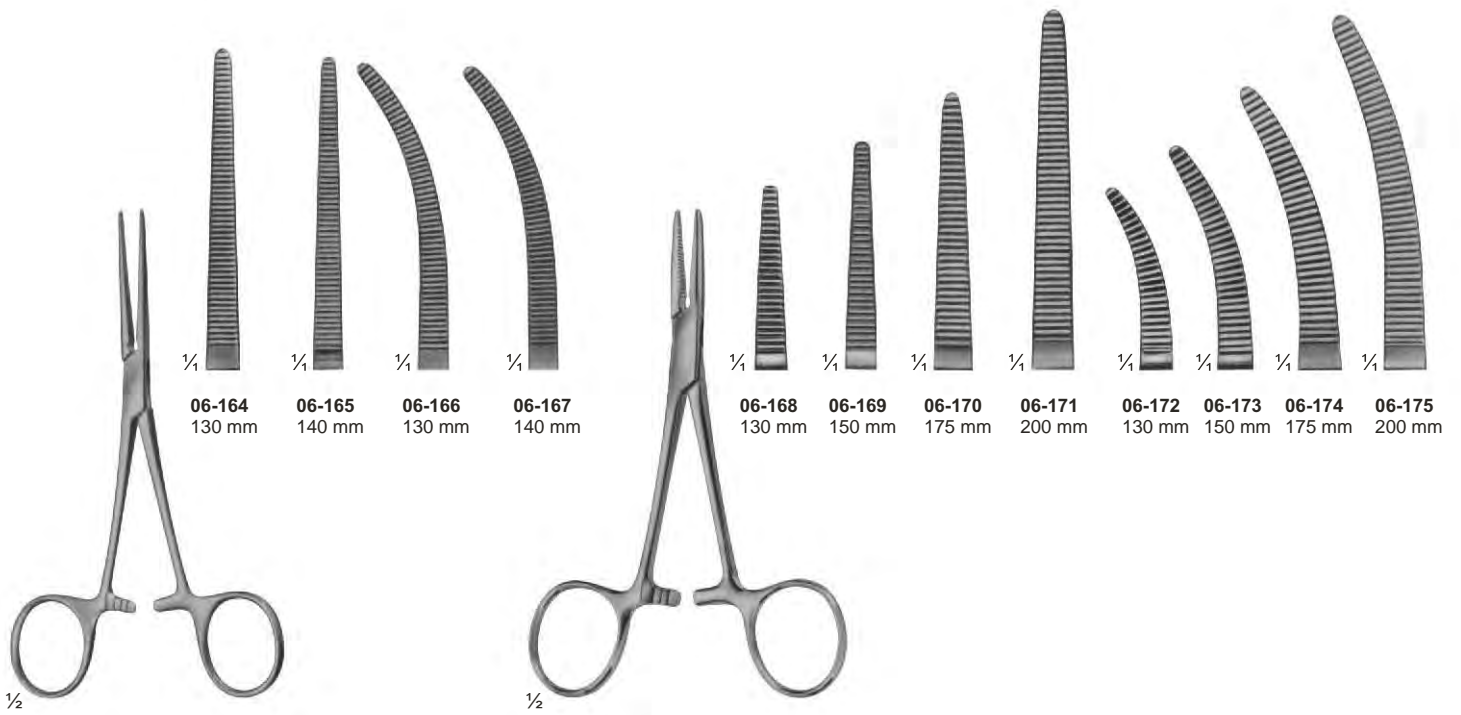

**06-164 - 167**  
PEAN  
Slender type

**06-168 - 175**  
SPENCER-WELLS  
Slender type

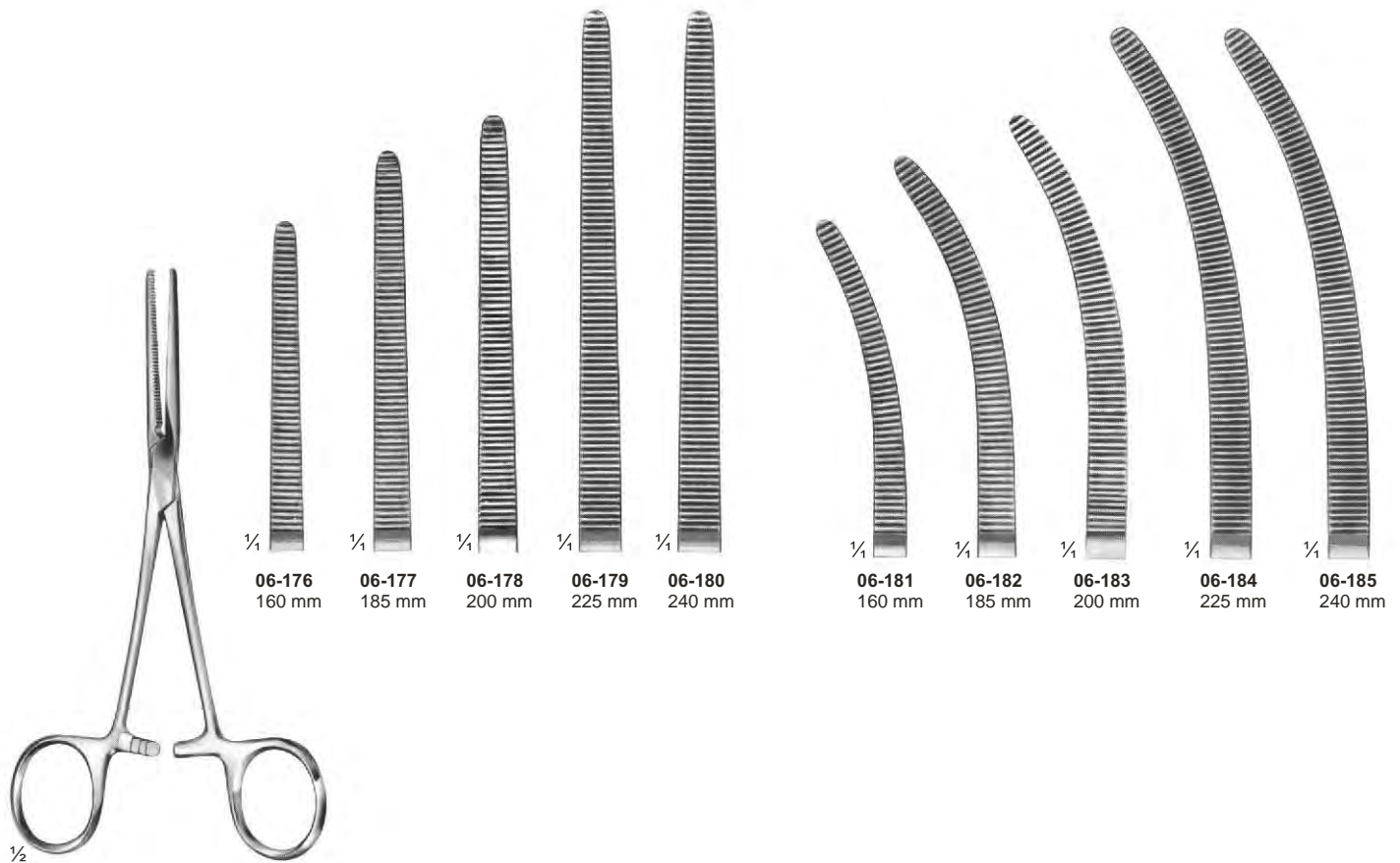

**06-176 - 185**  
ROCHESTER-PEAN

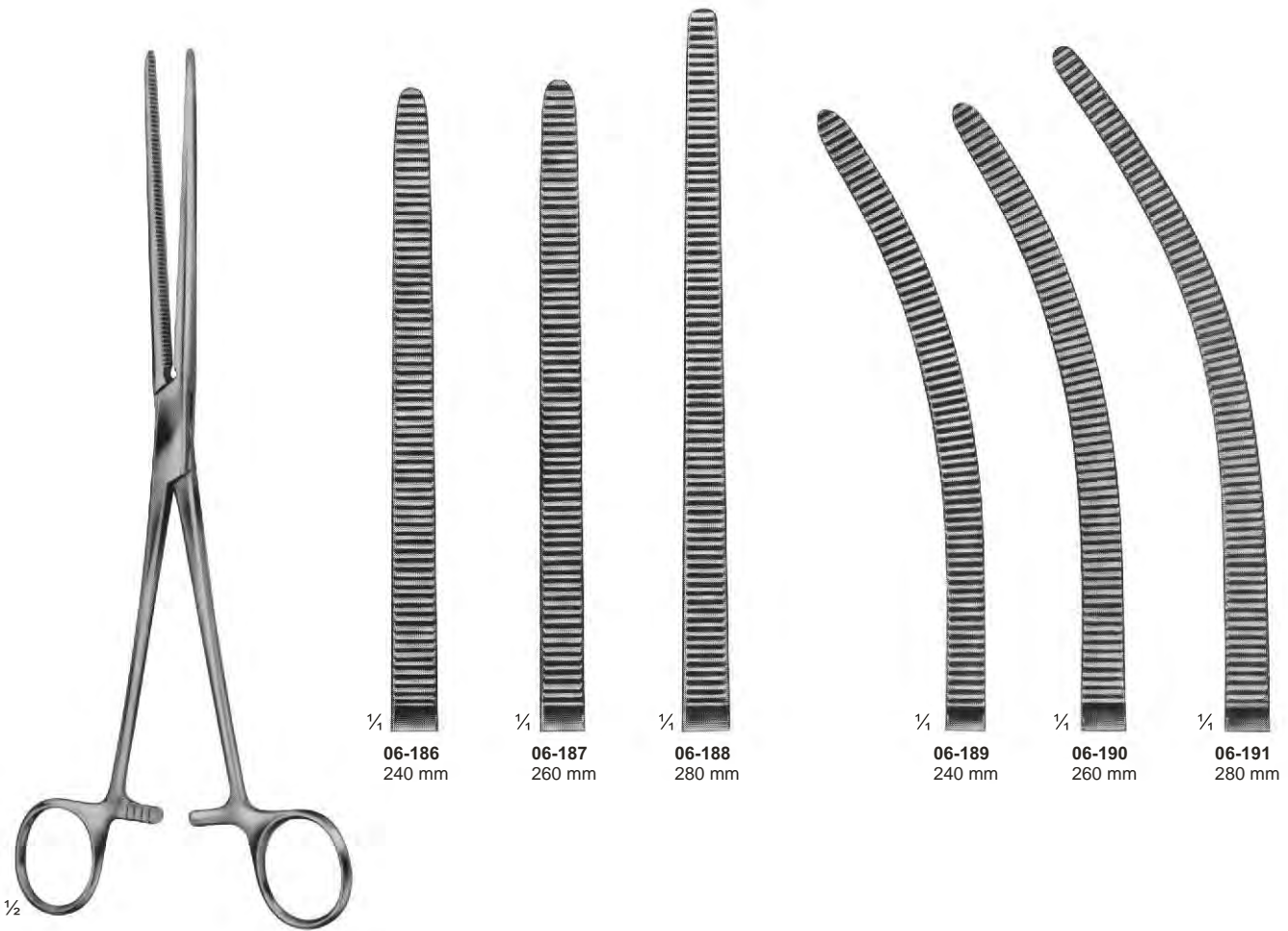

**06-186 - 191**  
PEAN

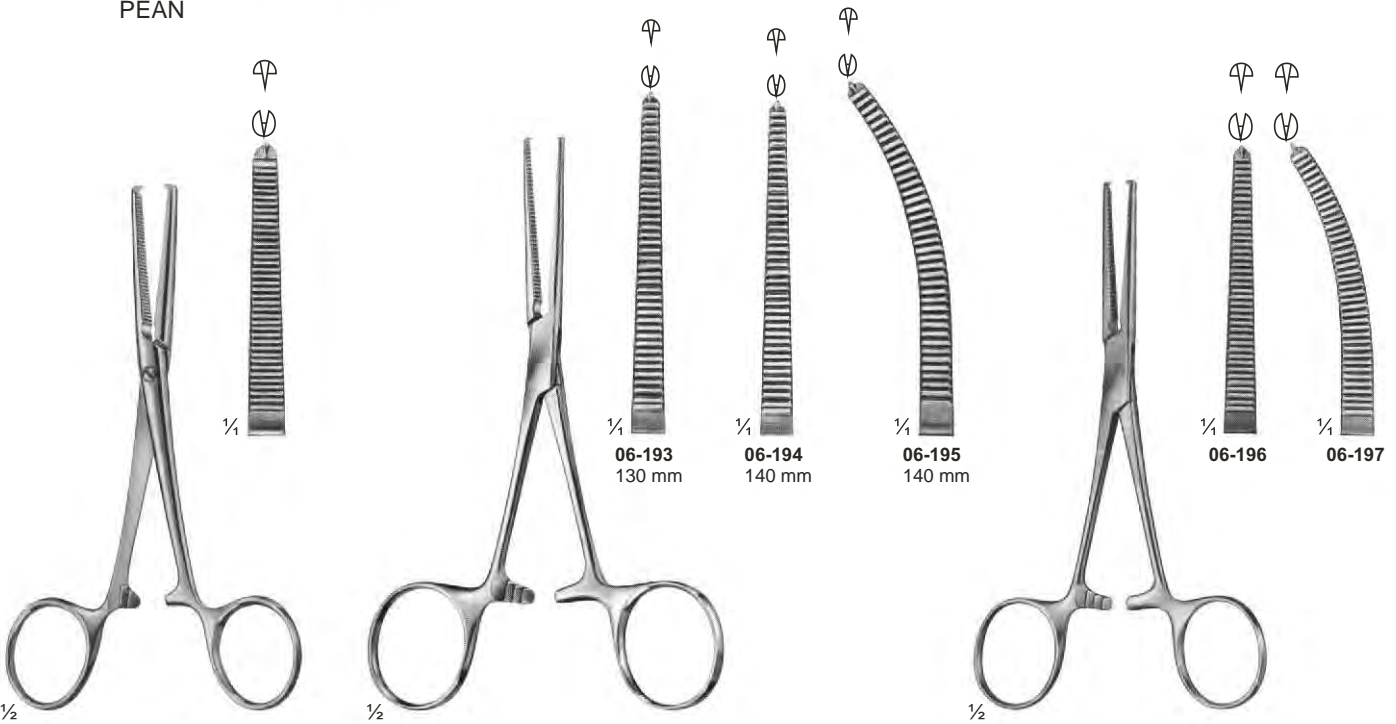

**06-192**  
KOCHER  
Strong Pattern  
145 mm

**06-193 - 195**  
KOCHER

**06-196 - 197**  
ROCHESTER-OCHSNER  
140 mm

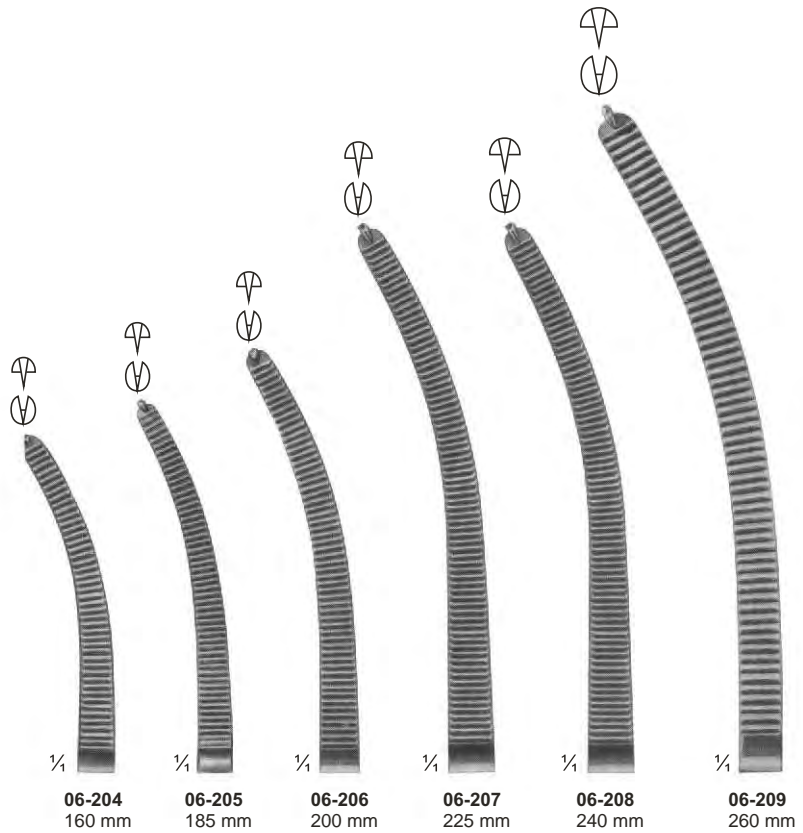
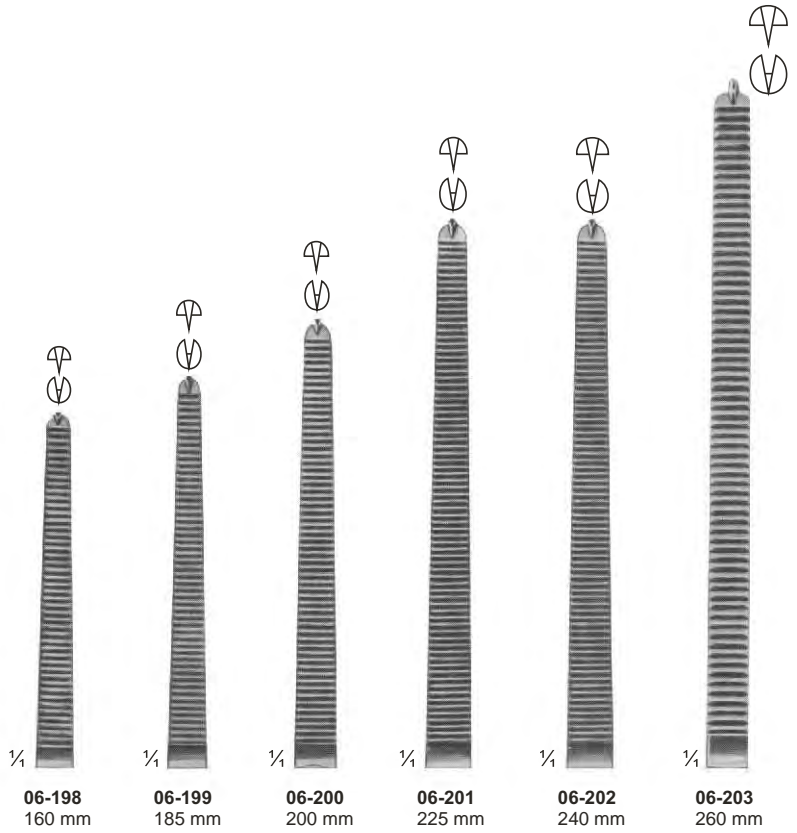

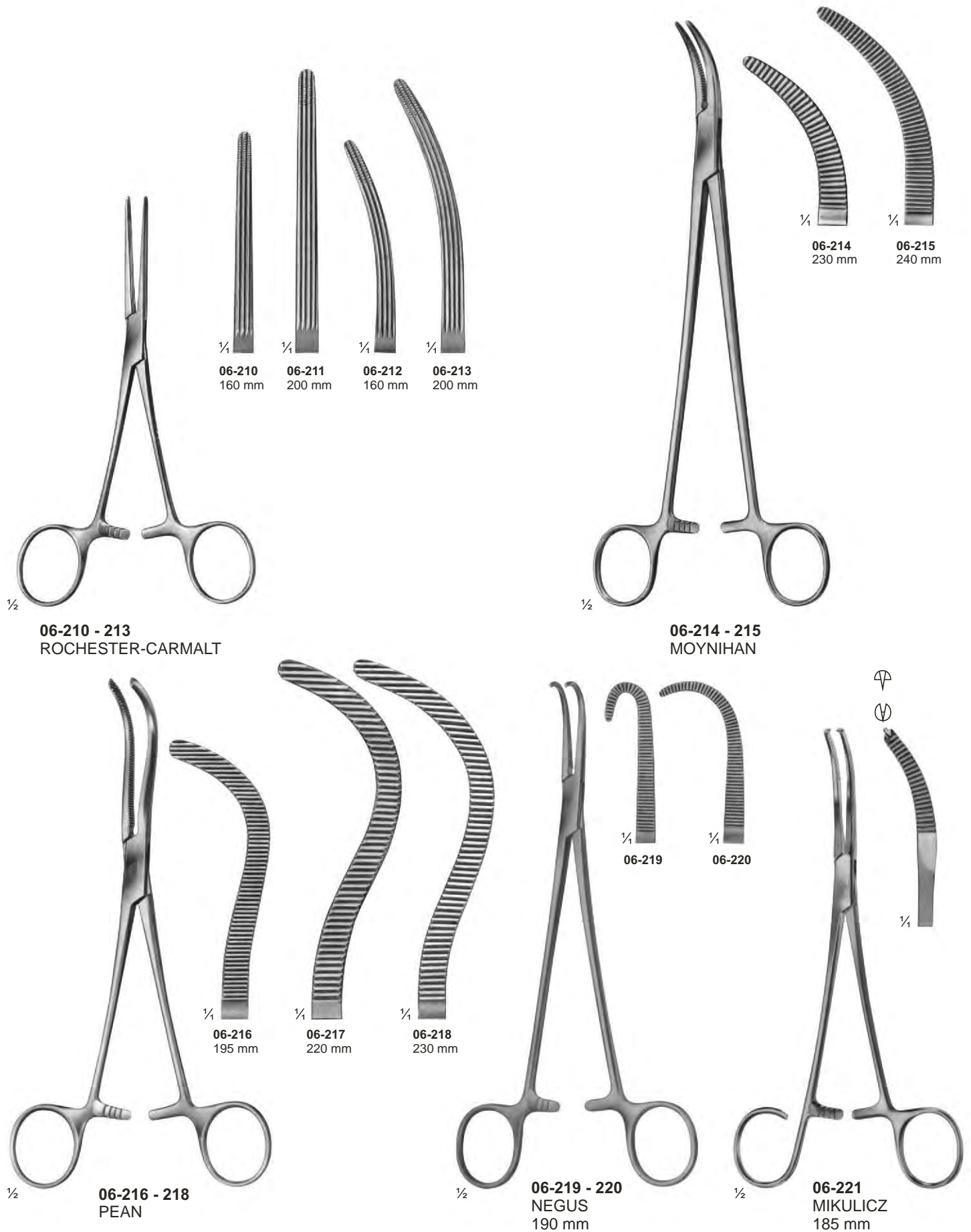



**06-222**  
MICRO-ADSON  
140 mm



**06-223**  
BABY-OVERHOLT  
135 mm



**06-224 - 225**  
BABY-MIXTER

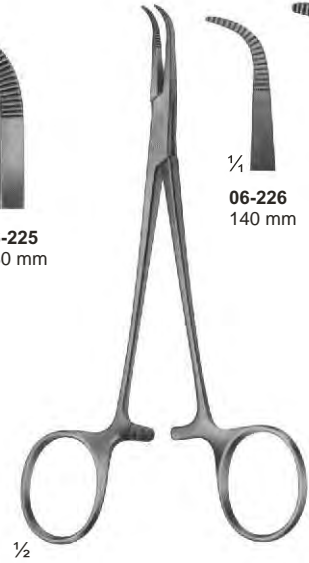
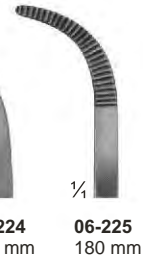

**06-226 - 227**  
BABY-ADSON

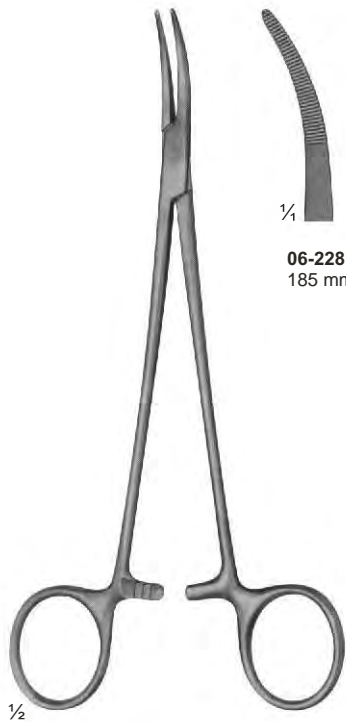
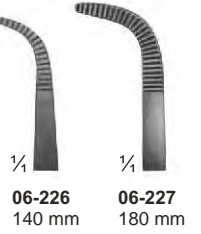

**06-228**  
NISSEN

**06-228**  
185 mm



**06-229 - 230**  
YASARGIL  
195 mm

**06-229**

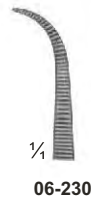

**06-230**



**06-231**  
OVERHOLT-MIXTER

**06-231**  
205 mm



**06-232 - 243**  
OVERHOLT-GEISSENDOERFER

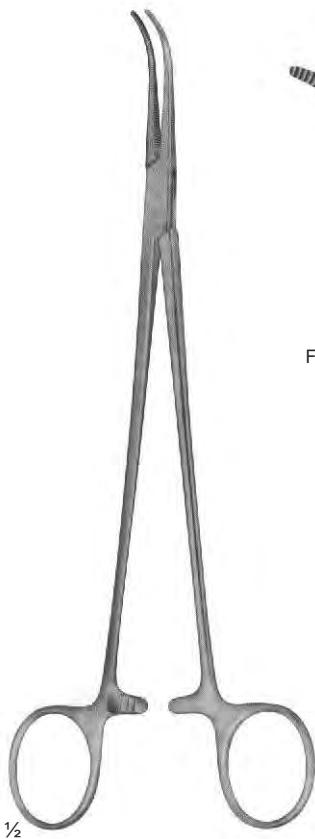
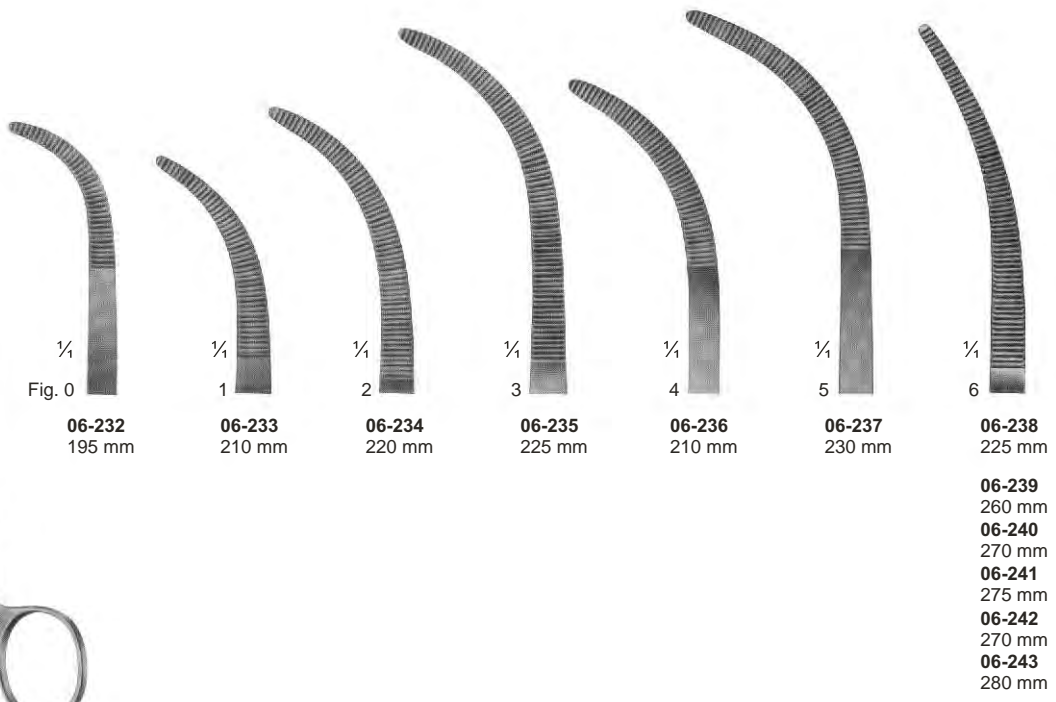

**06-244 - 251**  
OVERHOLT  
fine pattern

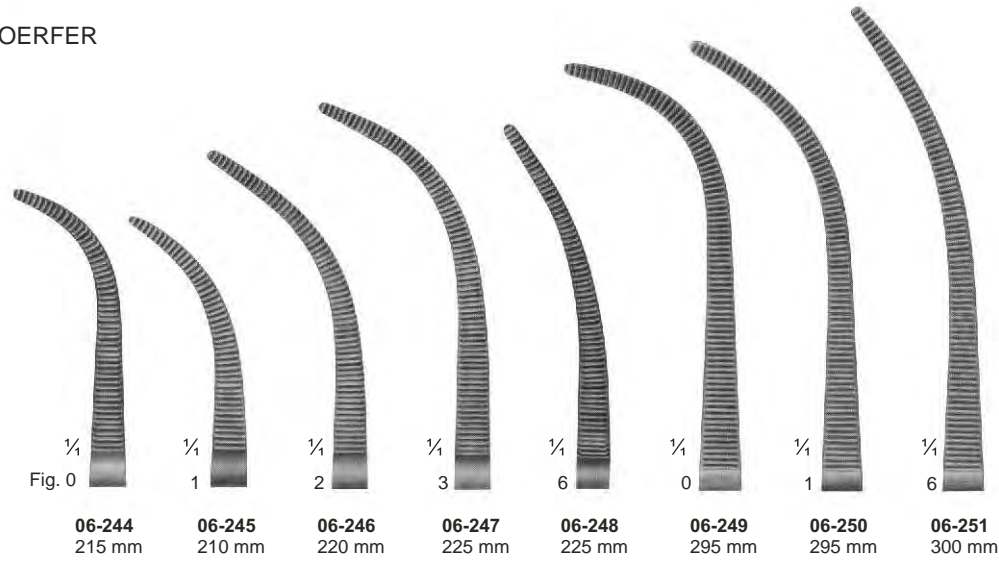



$\frac{1}{2}$   
**06-252**  
MIXTER-O'SHAUGHNESSY  
190 mm

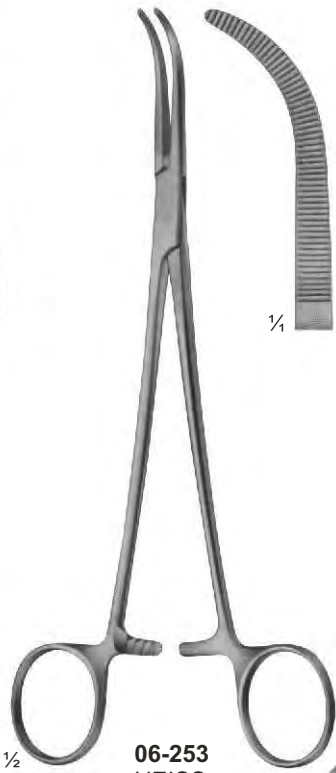

$\frac{1}{2}$   
**06-253**  
HEISS  
195 mm



$\frac{1}{2}$   
**06-254 - 258**  
RUMEL  
240 mm

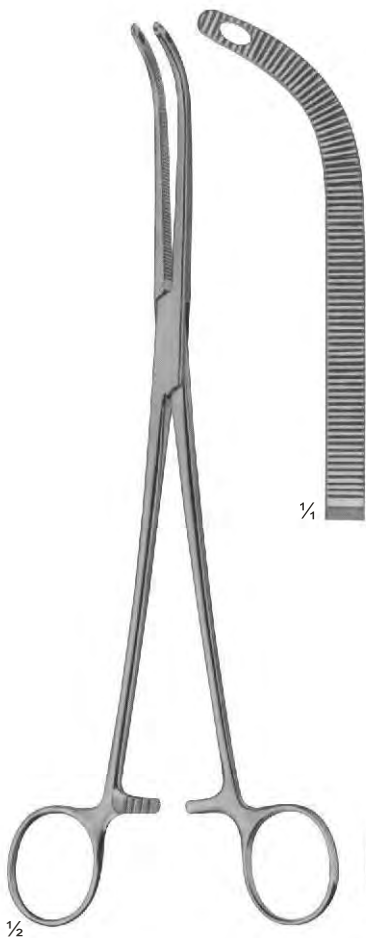

$\frac{1}{2}$   
**06-259**  
FINOCHIETTO  
245 mm

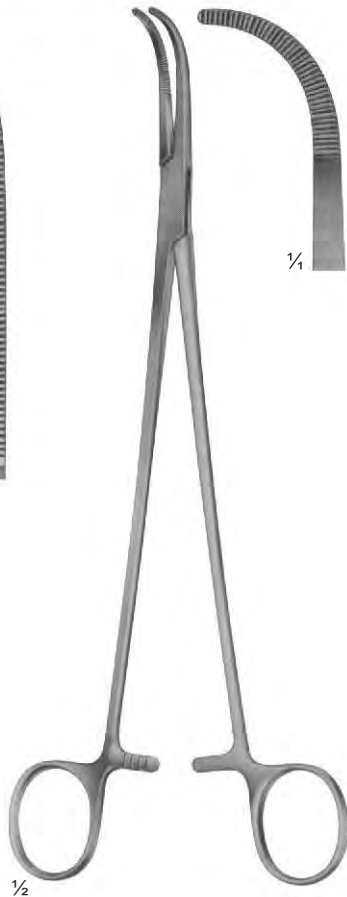

$\frac{1}{2}$   
**06-260**  
MIXTER  
230 mm



$\frac{1}{3}$   
**06-261**  
LAWRENCE  
270 mm

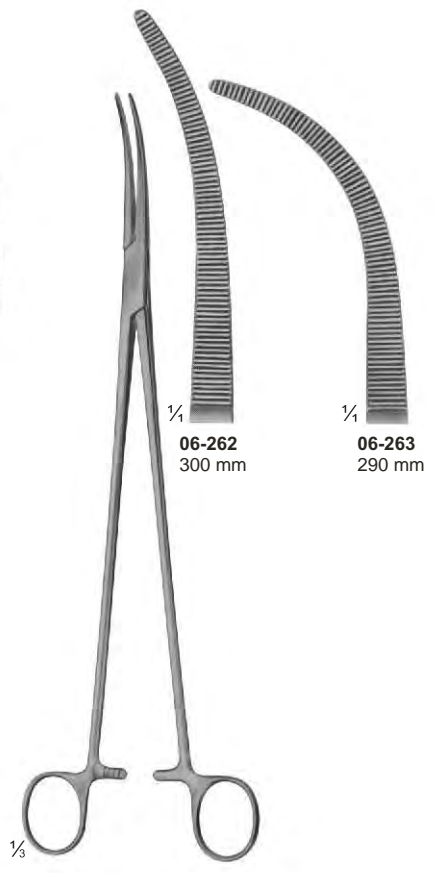

$\frac{1}{3}$   
**06-262 - 263**  
ZENKER

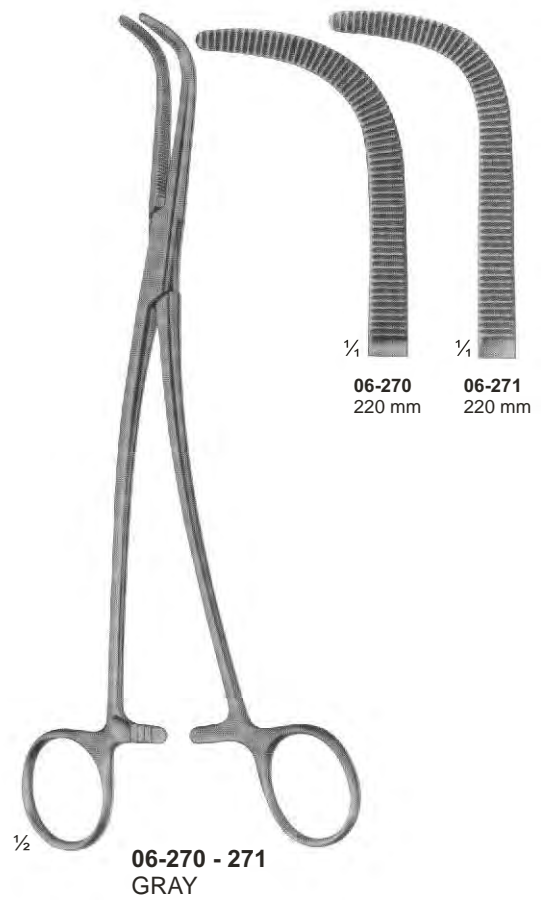
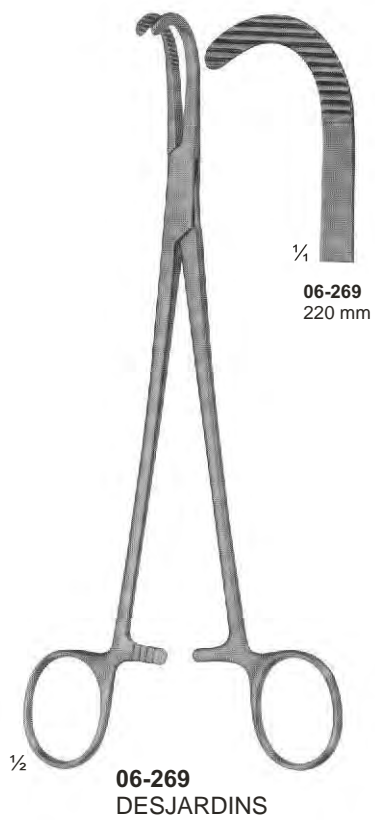

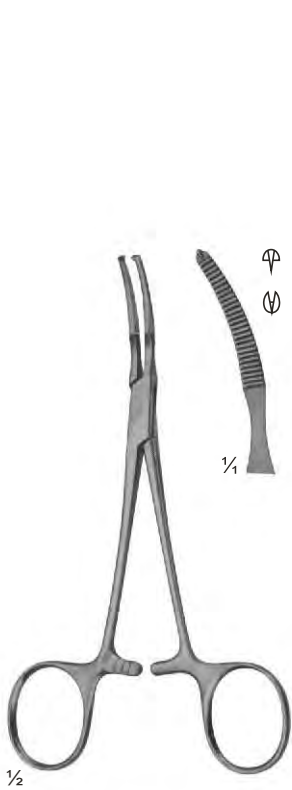

1/2  
**06-272**  
BABY-MIKULICZ  
140 mm

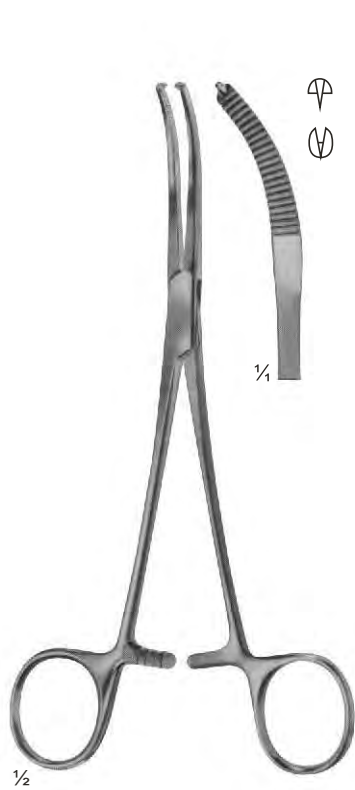

1/2  
**06-273**  
MIKULICZ  
185 mm

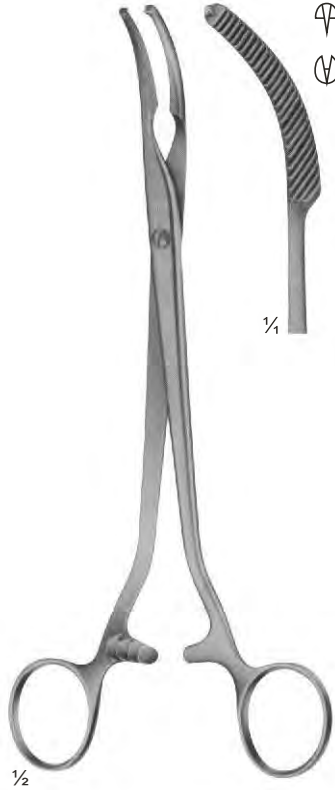

1/2  
**06-274**  
MIKULICZ  
205 mm

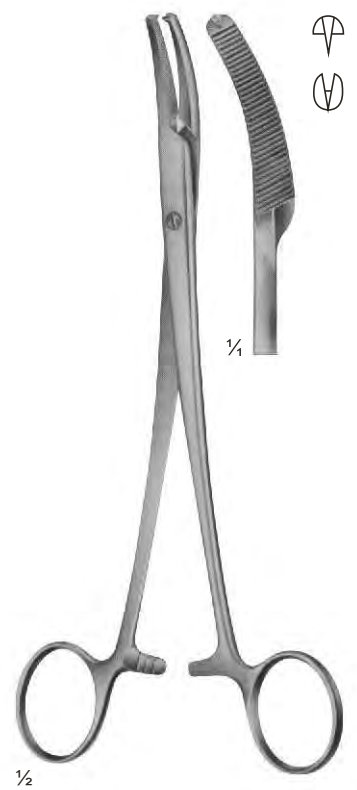

1/2  
**06-275**  
MIKULICZ  
200 mm

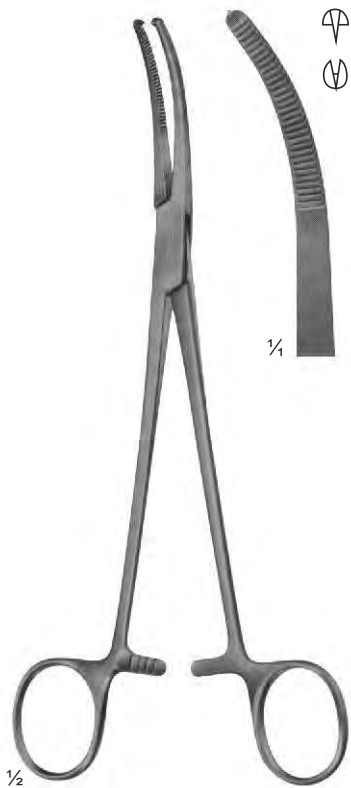

1/2  
**06-276**  
MIKULICZ  
205 mm

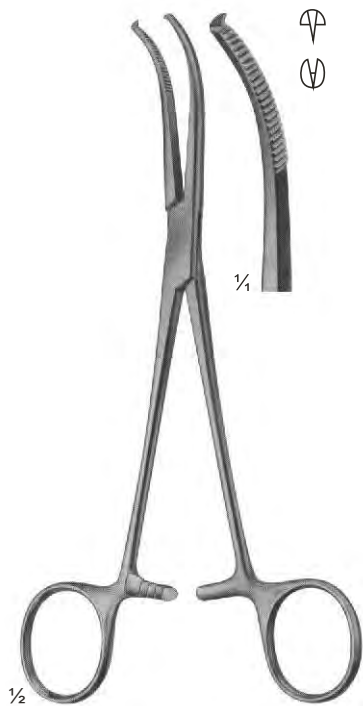

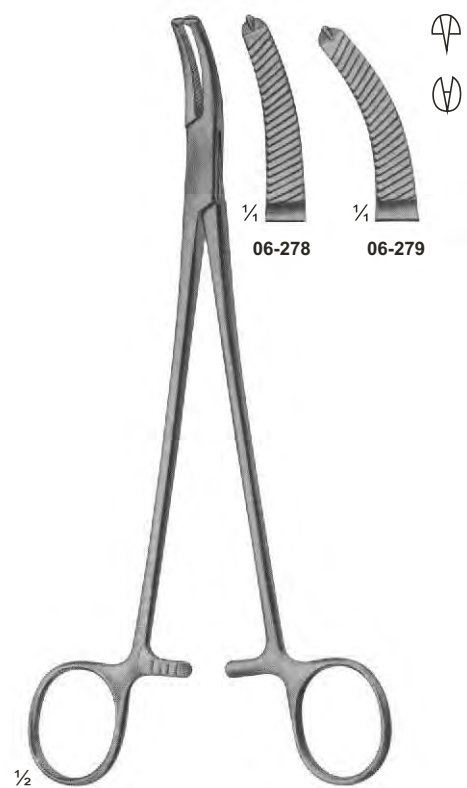

1/2  
**06-277**  
MIKULICZ  
185 mm



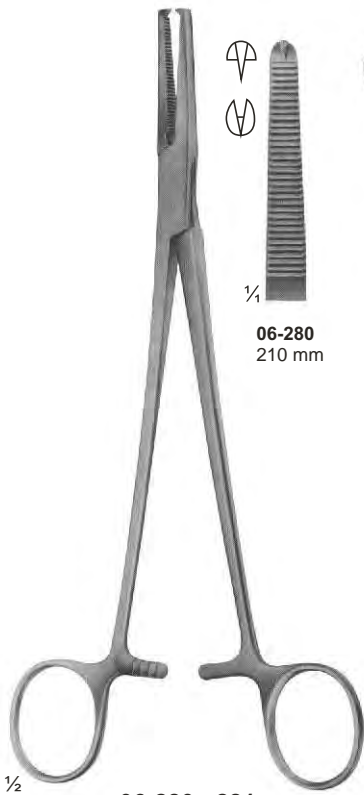

1/2  
**06-278 - 279**  
FAURE  
205 mm

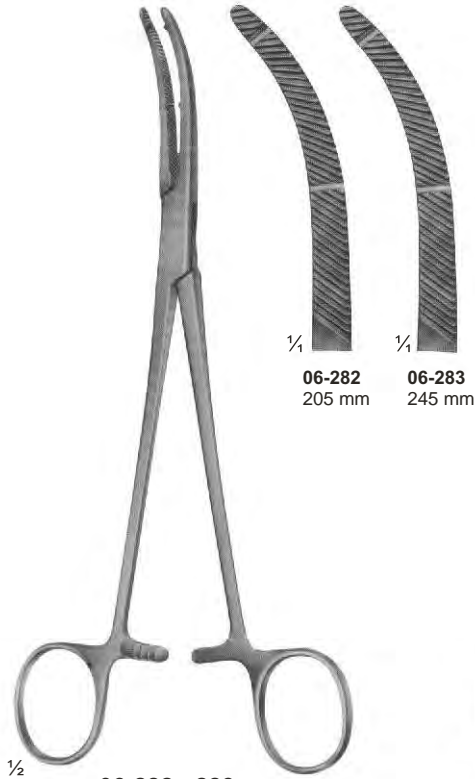

  
  
**06-280**  
 210 mm  
**06-281**  
 205 mm

**06-280 - 281**  
PHANEUF



  
  
**06-282**  
 205 mm  
**06-283**  
 245 mm

**06-282 - 283**  
HEANEY modif.



  
**06-284**  
 195 mm

**06-284**  
HEANEY

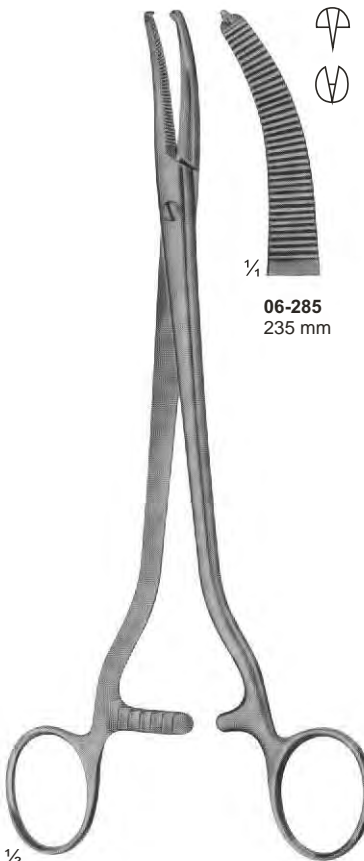

  
  
**06-285**  
 235 mm

**06-285**  
WERTHEIM

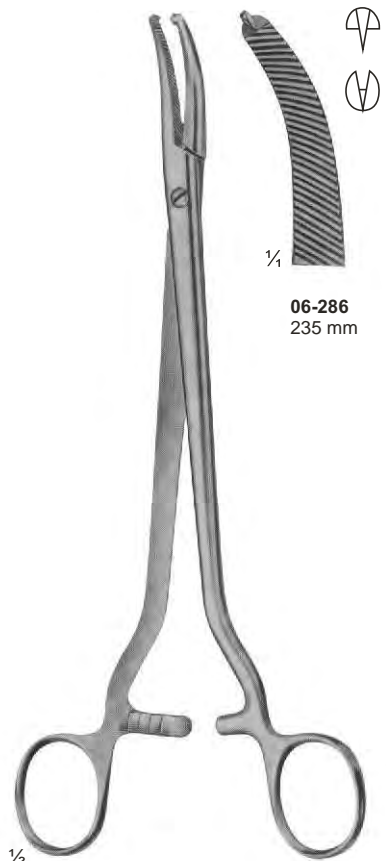

  
  
**06-286**  
 235 mm

**06-286**  
WERTHEIM



  
  
**06-287**  
 245 mm

**06-287**  
WERTHEIM



**06-288**  
225 mm



**06-289**  
220 mm



**06-290**  
215 mm

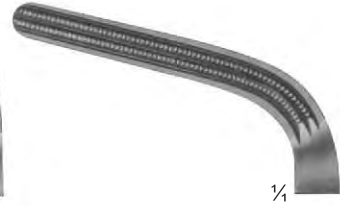

**06-291**  
205 mm



**06-292**  
250 mm



**06-293**  
245 mm



**06-294**  
240 mm

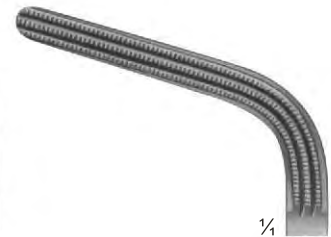

**06-295**  
220 mm

# Hysterectomy Forceps and Vaginal Clamps and Compression Forceps



1/2  
**06-296**  
 WERTHEIM  
 Hysterectomy Forceps  
 255 mm

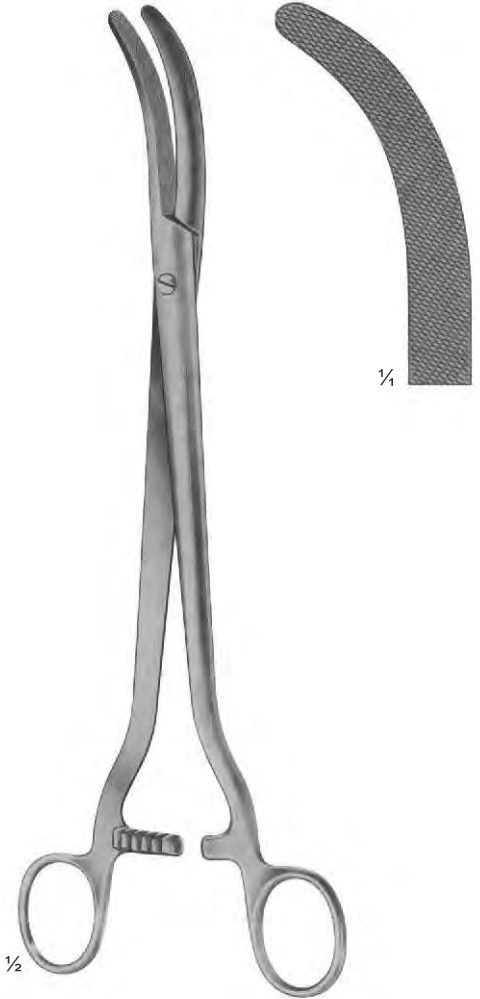

1/2  
**06-297**  
 WERTHEIM  
 Parametrium Clamp  
 260 mm



1/2  
**06-298 - 300**  
 DICK



1/4  
**06-298** 255 mm  
**06-299** 265 mm  
**06-300** 275 mm

# Hysterectomy Forceps and Vaginal Clamps and Compression Forceps



**06-301**  
WERTHEIM  
250 mm

1/2

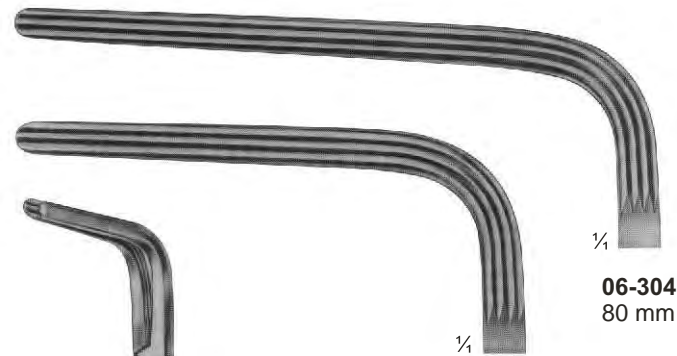

**06-304**  
80 mm

1/4

**06-303**  
60 mm



1/2

**06-303 - 304**  
230 mm



1/2

**06-302**  
WERTHEIM-CULLEN  
215 mm



**07-101**  
ROHRSCHEIDER  
With copper inserts  
100 mm



**07-102**  
KALT  
With catch  
135 mm



**07-103**  
ARRUGA  
With catch  
135 mm



**07-104 - 105**  
CASTROVIEJO  
With catch  
145 mm



**07-106 - 107**  
CASTROVIEJO  
With Catch  
160 mm



**07-108 - 109**  
Without catch  
185 mm



**07-109**



**07-110 - 111**  
JACOBSON  
185 mm

**07-110**  
Without catch

**07-111**  
With catch



**07-112**  
Without catch  
195 mm



**07-113 - 114**  
YASARGIL  
With catch  
200 mm

**07-113**

**07-114**



**07-115 116**  
BARRAQUER  
Without catch



**07-117 - 118**  
BARRAQUER  
Without catch  
120 mm



**07-119 - 120**  
BARRAQUER  
With catch  
120 mm



**07-121 - 122**  
BARRAQUER  
With Catch  
150 mm



**07-123**  
MULLER  
With Locking  
Mechanism  
145 mm



**07-124 - 125**  
BROCK  
Without catch  
150 mm



**07-126 - 127**  
YASARGIL  
200 mm



**07-128 - 129**  
YASARGIL  
225 mm



**07-130**  
YASARGIL  
245 mm



1/2 **07-131**  
CONVERSE  
125 mm



1/2 **07-132**  
WEBSTER  
125 mm



1/2 **07-133 - 134**  
HALSEY  
130 mm

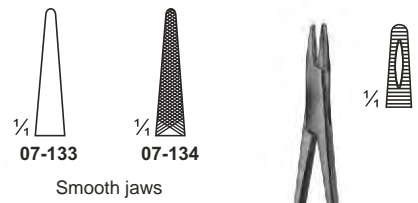

1/2 **07-135**  
DERF  
130 mm



1/2 **07-136**  
DOYEN  
125 mm



1/2 **07-137**  
BAUMGARTNER  
145 mm

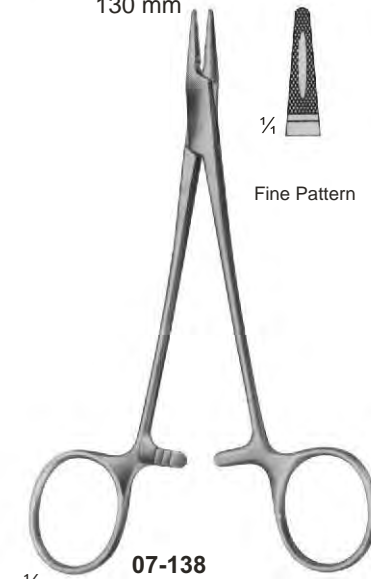

1/2 **07-138**  
CRILE-WOOD  
150 mm



1/2 **07-139**  
CRILE-WOOD  
160 mm



1/2 **07-140**  
CRILE-MURRAY  
150 mm

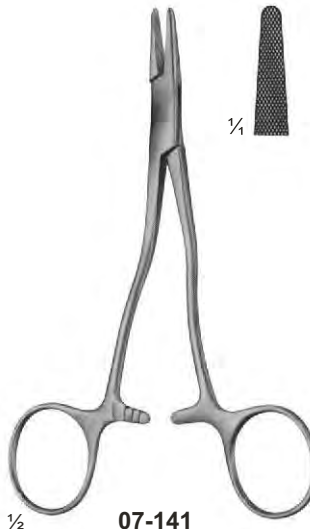

1/2 **07-141**  
KILNER  
135 mm



1/2 **07-142**  
ADSON  
175 mm

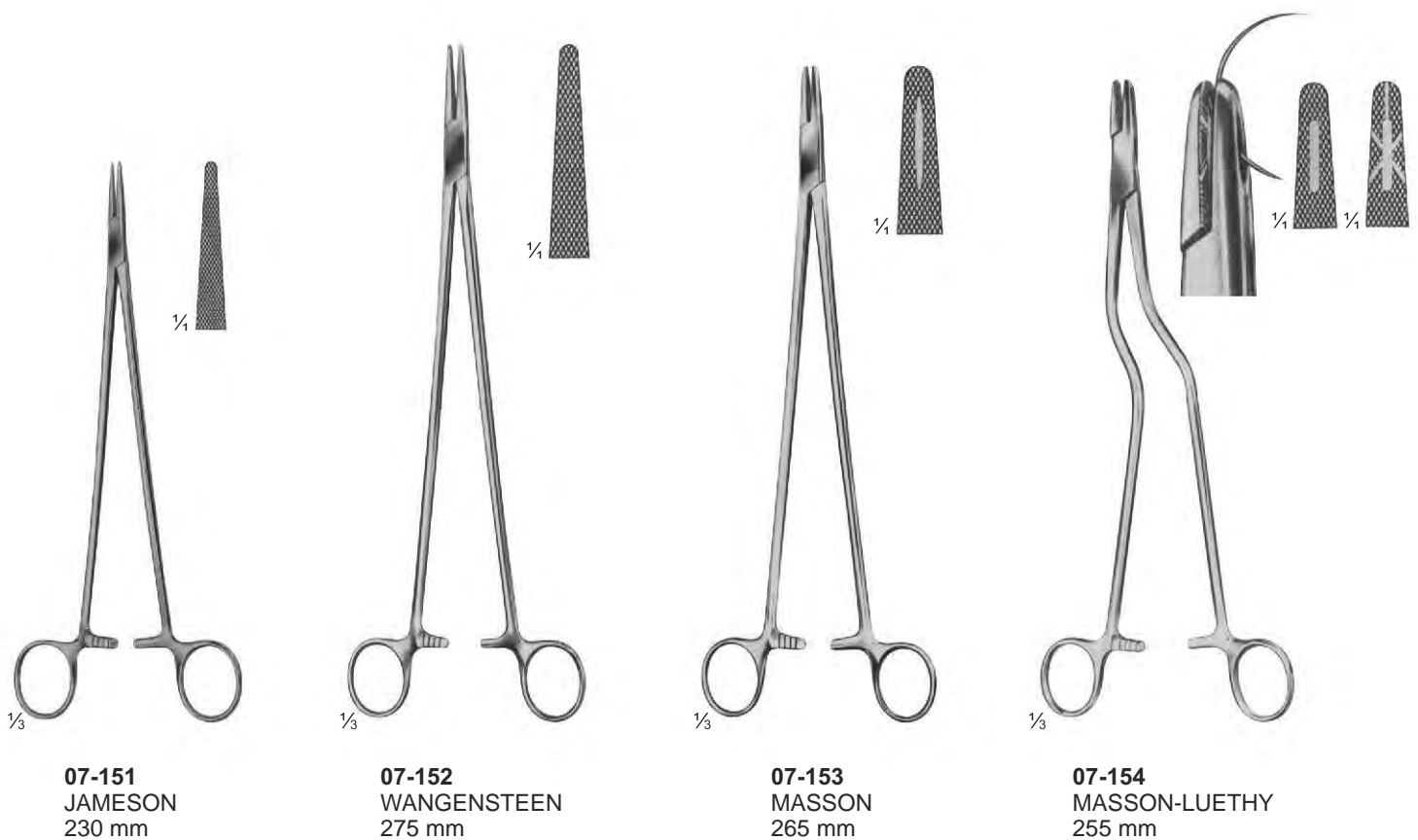

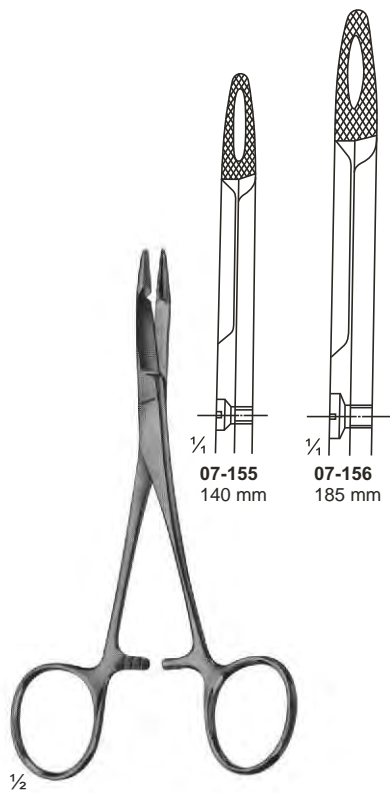

**07-155 - 156**  
HEGAR-OLSEN  
255 mm

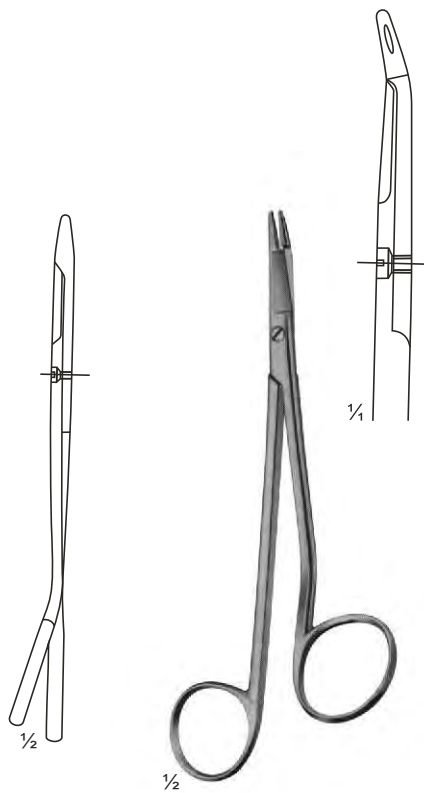

**07-157**  
GILLIES  
150 mm

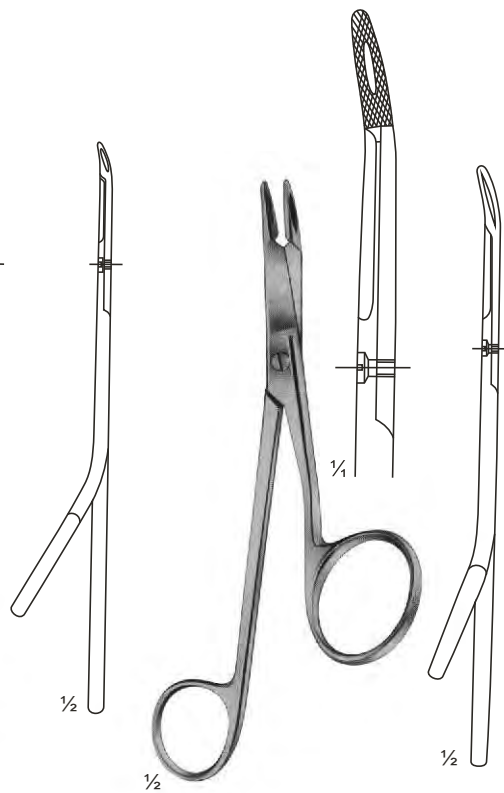

**07-158**  
GILLIES  
160 mm

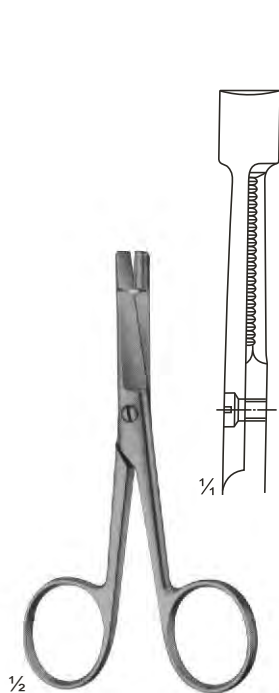

**07-159**  
EISELSBERG  
115 mm

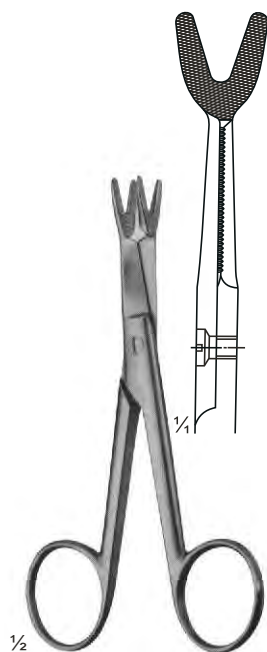

**07-160**  
SCHOEMAKER-LOTH  
125 mm



**07-161**  
CRILE  
150 mm



**07-162**  
TONNIS  
Elastic pattern for  
dura-or intestinal suture  
180 mm

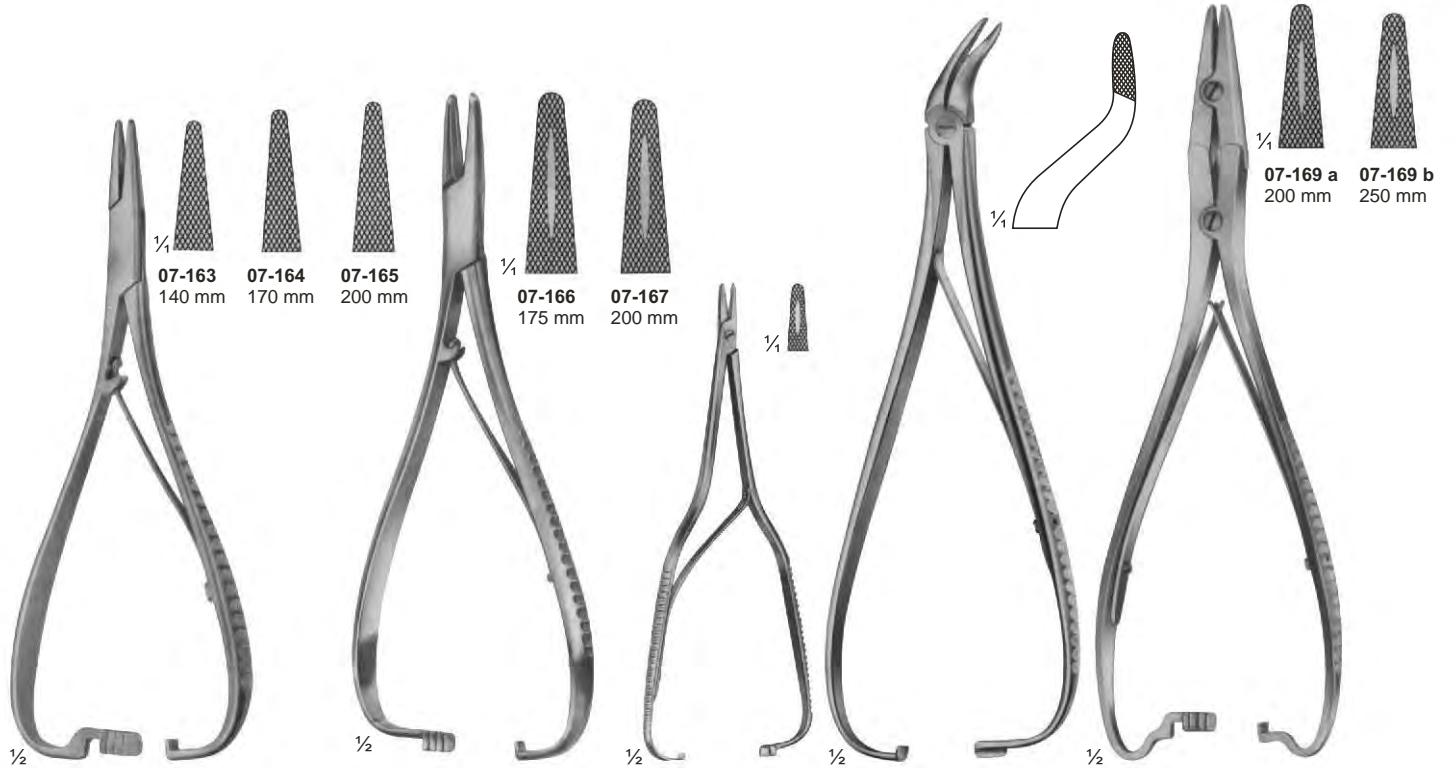

**07-163 - 165**  
MATHIEU

**07-166 - 167**  
MATHIEU-STILLE  
Very heavy models

**07-168**  
BOYNTON  
125 mm

**07-169**  
EISELSBERG-MATHIEU  
For palate suture  
195 mm

**07-169 a - 169 b**

**07-169 a**  
200 mm

**07-169 b**  
250 mm



**07-170**

**07-171**

**07-172**



**07-173** 1/2  
YOUNG-HRYNTSCHAK  
With 1 needle  
240 mm

**07-174** 1/2  
YOUNG-MILLIN  
With 1 needle  
200 mm



**07-175**  
MILLIN  
Ligature holding forceps  
245 mm

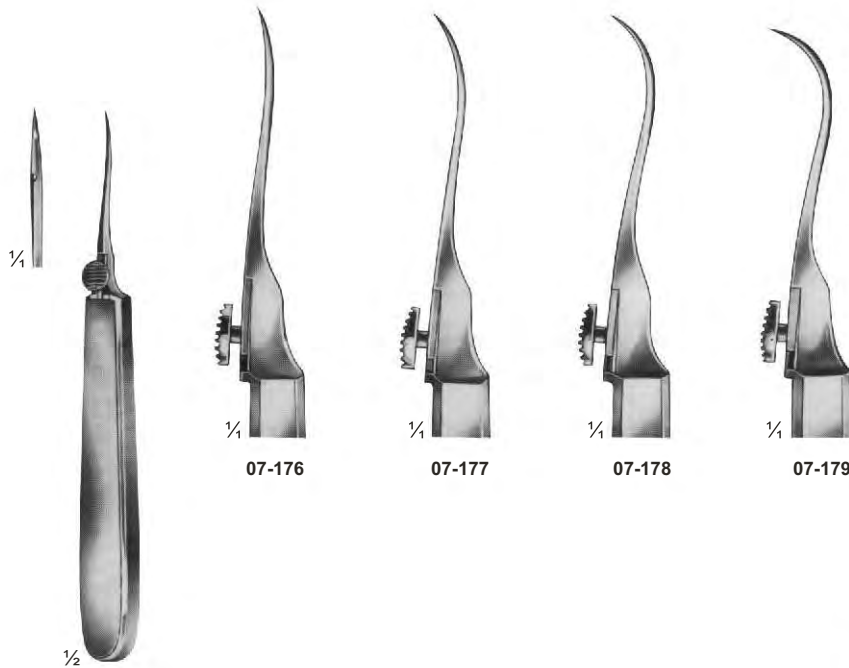

**07-176 - 179**  
REVERDIN  
140 mm



**07-180 - 183**  
REVERDIN  
195 mm

**07-184 - 188**  
REVERDIN  
220 mm

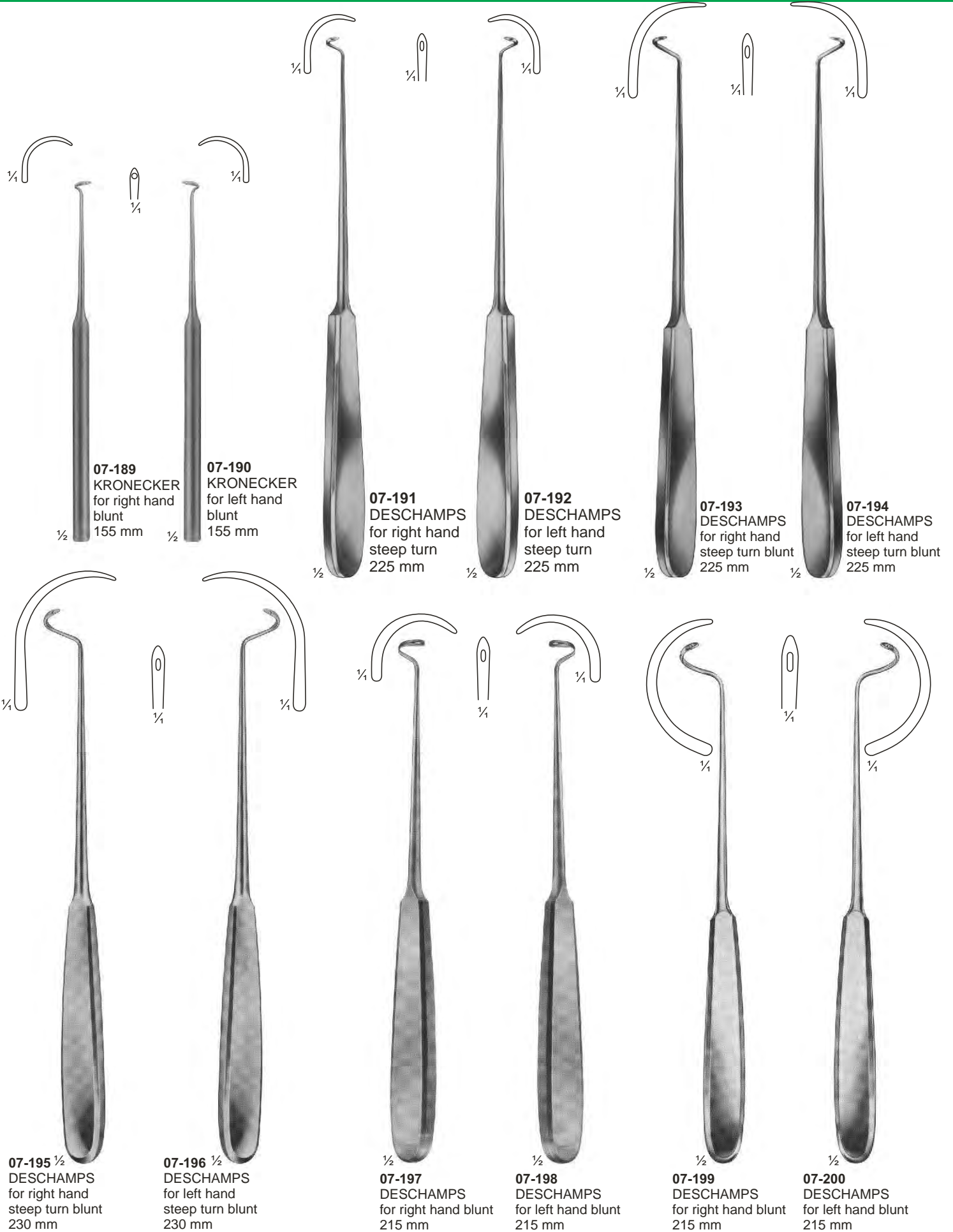



1/2  
**07-201**  
HURD  
for right hand  
sharp  
210 mm



1/4  
**07-202**  
HURD  
for left hand  
sharp  
210 mm



1/4  
**07-203**  
DESCHAMPS  
for right hand  
sharp  
215 mm



1/4  
**07-204**  
DESCHAMPS  
for left hand  
sharp  
215 mm



1/4  
**07-205**  
JONESCO  
Needle for wire suture  
185 mm



1/4  
**07-206**  
CLAUS VAN EICKEN  
Needle for wire suture  
250 mm

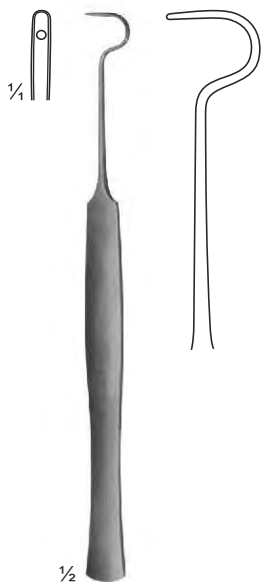

1/4  
**07-207**  
150 mm

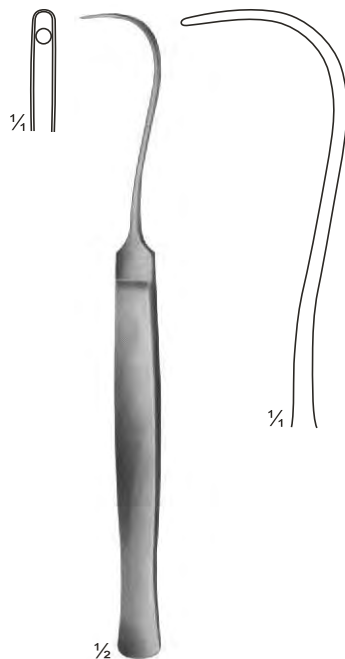

1/4  
**07-208**  
SYME  
170 mm

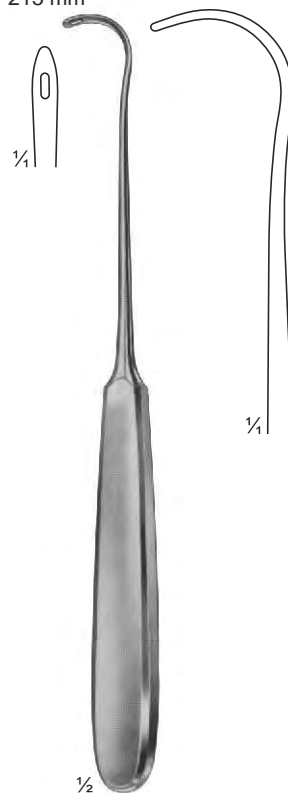

1/4  
**07-209**  
COOPER  
205 mm

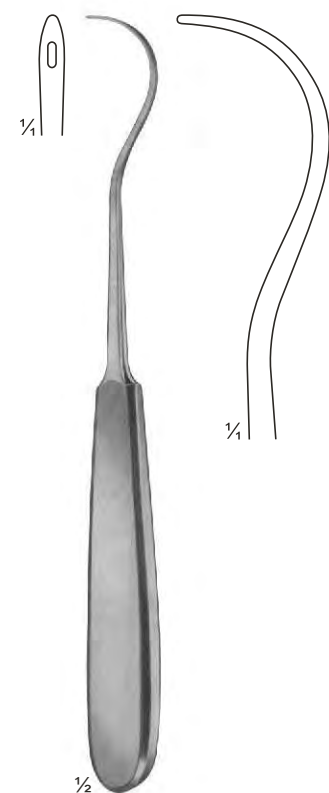

1/4  
**07-210**  
KOCHER  
205 mm

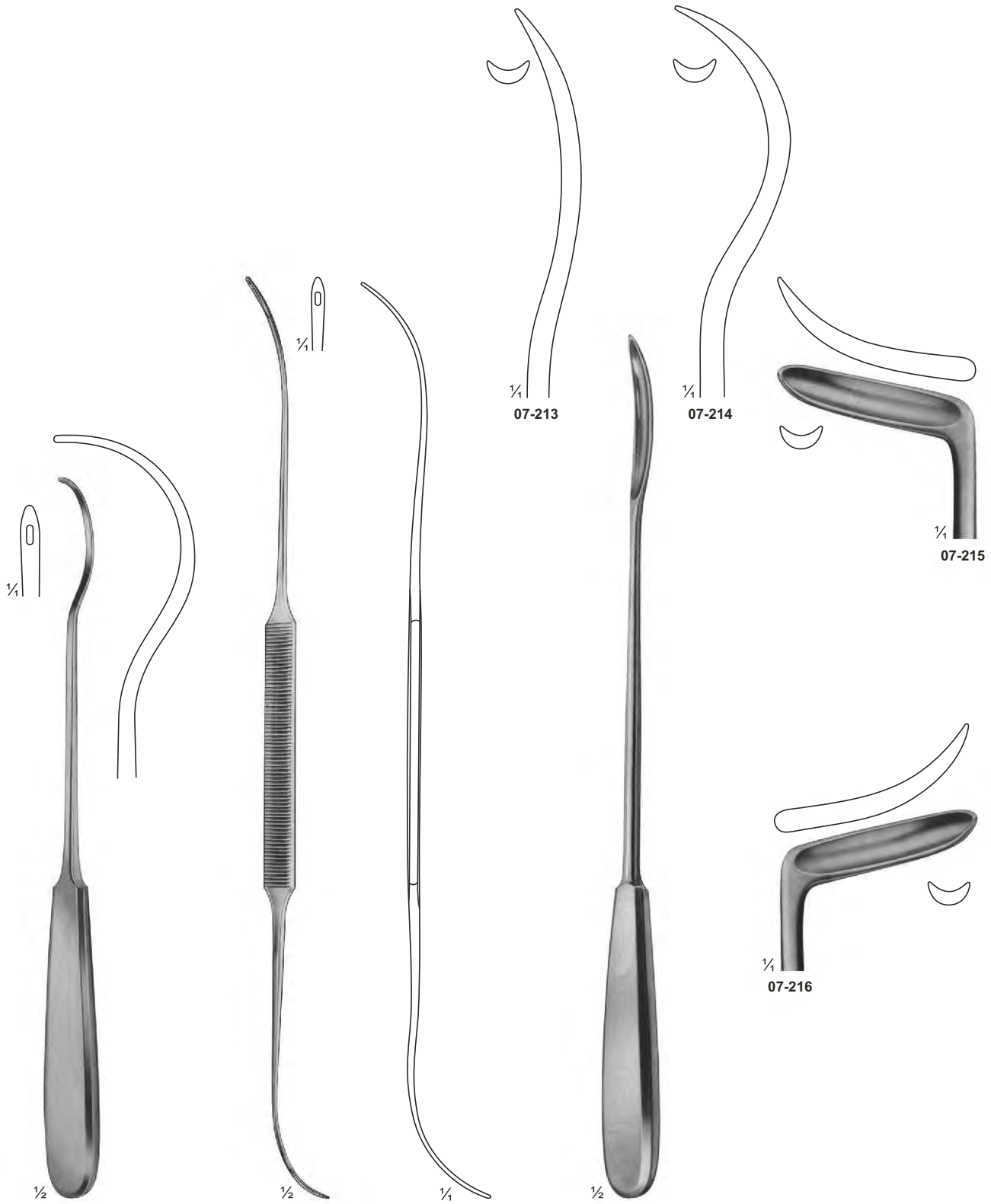

**07-211**  
BRUNNER  
240 mm

**07-212**  
SCHMIEDEN-DICK  
320 mm

**07-213 - 216**  
BRUNNER  
Guiding Probes  
300 mm





**07-242** 2,5 mm  
**07-243** 2,5 mm  
**07-244** 3,0 mm

1/2

**07-242** 145 mm  
**07-243** 160 mm  
**07-244** 200 mm  
 Probes with eye



1,5 mm

1/2

**07-245**  
 Myrtle leaf probe  
 145 mm



2,0 mm

1/2

**07-246** 130 mm  
**07-247** 145 mm  
**07-248** 160 mm  
**07-249** 180 mm  
**07-250** 200 mm



1/2

**07-251**  
 Probes



1/2

**07-252**  
 Double ended probe,  
 malleable, diam. of tips  
 3 mm with hole  
 190 mm



**07-253**  
 Double ended probes,  
 tin, malleable,  
 diam. of tips  
 3,5 mm with hole  
 250 mm, 300 mm



1/4

**07-254**  
 Double ended probes,  
 tin, malleable,  
 diam. of tips 4 mm  
 400 mm



1/3

$\varnothing$  tip  
**07-255** 1,5 mm  
**07-256** 2,0 mm  
**07-257** 2,5 mm  
 300 mm



**07-258**  
STACKE  
100 mm



**07-259**  
KILLIAN  
165 mm



**07-260**  
160 mm



**07-261**  
SEIFFERT  
180 mm



German Silver

**07-262**  
BOWMAN  
130 mm



**07-263**  
SPATULA  
145 mm



**07-264**  
SPATULA  
145 mm



**07-265**  
Modell PICCOLO  
Round Serrated  
110 mm



**07-266**  
Modell PICCOLO  
Triangular Serrated end  
110 mm



**07-267**  
FARRELL  
Round Serrated end  
110 mm



**07-268**  
LATHBURY-FARREL  
Triangular Serrated end  
110 mm





**07-269**  
BUCK  
Rough, spiral end  
120 mm

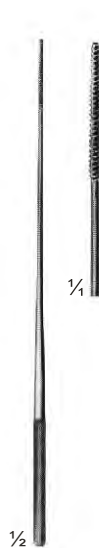

**07-270**  
Triangular  
serrated end  
140 mm



**07-271**  
Rough, spiral end  
140 mm



**07-272**  
Rough, spiral end  
140 mm



**07-273**  
Rough, spiral end  
140 mm



**07-274**  
FARRELL  
Round,  
serrated end  
140 mm



**07-275**  
LATHBURY-FARRELL  
Triangular,  
serrated end  
140 mm



**07-276**  
FARRELL  
Rough,  
spiral end  
160 mm



**07-277**  
LATHBURY-FARRELL  
Triangular,  
serrated end  
160 mm



**07-278**  
Triangular,  
serrated end  
160 mm

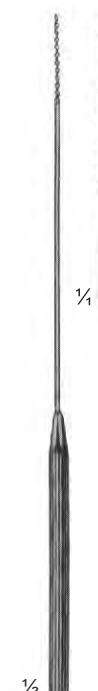

**07-279**  
Rough,  
spiral end  
180 mm



**07-280**  
Rough,  
spiral end  
180 mm



**07-281**  
Rough,  
spiral end  
270 mm



½

**07-282**  
MICHEL  
125 mm



½

**07-283**  
HEGENBARTH  
120 mm



½

**07-284**  
WACHENFELDT  
120 mm



½

**07-285**  
WACHENFELDT  
120 mm



½

**07-286**  
MICHEL  
125 mm



½

**07-287**  
MICHEL modif.  
130 mm



½

**07-288**  
HEATH  
135 mm



½

**07-289**  
COLLIN  
135 mm



## 07-290

Suturing instruments set, in metal case consisting of: Scissors, curved, sharp/sharp, 115mm  
25 MICHEL clip, 16 x 3mm  
1 Delicate tissue forceps, 130mm  
1 Scalpel, bellied  
1 MATHIEU needle holder, 140mm  
1 Perforated metal case, stainless containing:  
1 Suture needle  
1 item 1 item



## 07-291

Pocket instrument set, in metal case consisting of:

### Bottom tray

1 MATHIEU needle holder, 140mm  
1 MICHEL clip forceps, combined  
1 Myrtle leaf probe, 130mm  
1 Sharp double curette  
1 Skin hook  
1 Detachable scalpel handle, no.4  
1 Perforated metal case, containing  
6 Scalpel blades BB 520  
1 Perforated metal case, stainless, containing  
1 Suture needle  
1 item  
1 item

### Top tray

1 Tissue forceps, 130mm  
1 KOCHER haemostatic forceps, 130mm  
1 Straight surgical scissors, 130mm  
1 Dissecting forceps, 130mm  
1 FEILCHENFELD splinter forceps, 115mm  
25 MICHEL clip, 16 x 3mm  
1 Flacon of suture skin, sterile in alcohol



## 07-292

Pocket instrument set, in metal case consisting of:

### Bottom tray

1 MAYO-HEGER needle holder, 150mm  
1 MICHEL clip forceps, combined  
1 Myrtle leaf probe, 130mm  
1 Sharp double curette  
1 Skin hook  
1 Detachable scalpel handle, no. 4  
1 Perforated metal case, consisting  
6 Scalpel blades BB 520  
1 Perforated metal case, stainless, consisting:  
1 Suture needle  
1 item, & 1 item

### Bottom tray

1 Tissue forceps, 130mm  
1 CRILE haemostatic forceps, 140mm  
1 Straight surgical scissors, 130mm  
1 Dissecting forceps, 130mm  
1 FEILCHENFELD splinter forceps, 115mm  
25 MICHEL clip, 16 x 3mm  
1 Flacon of suture silk, sterile in alcohol



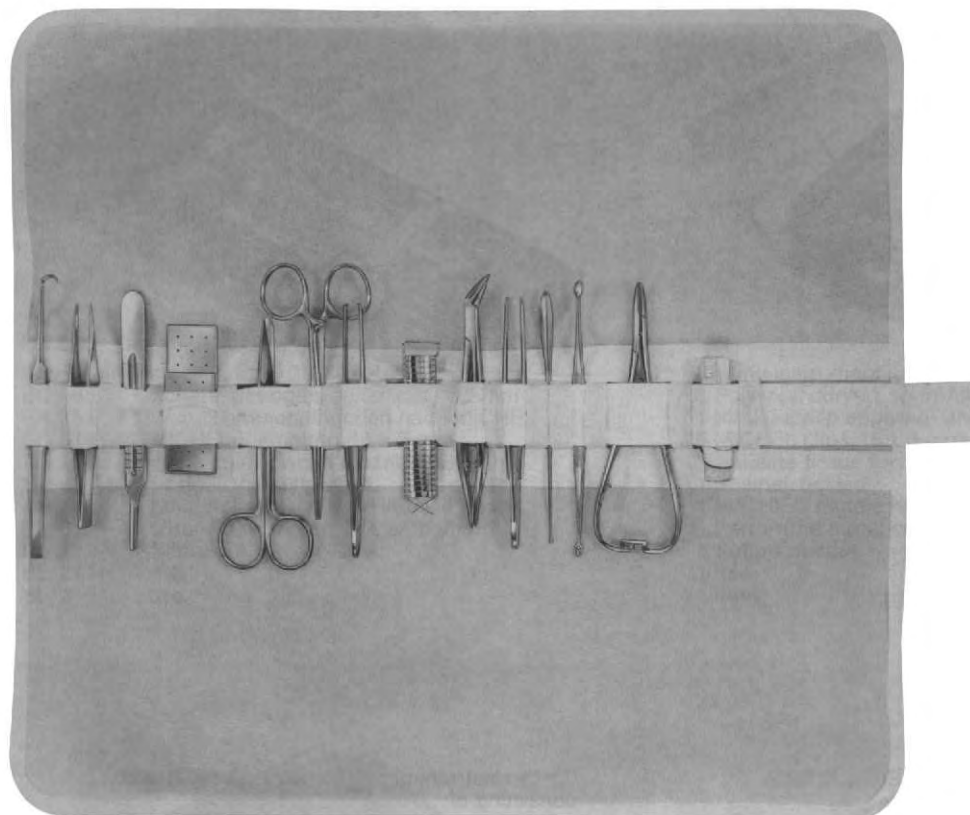

## 07-293

Pocket instrument set in metal case 170 x 90mm with sterilizable canvas roll consisting of:

- 1 Myrtle leaf probe, 130mm
- 1 Sharp double curette
- 1 FEILCHENFELD splinter forceps, 115mm
- 1 Dissecting forceps, 130mm
- 1 Tissue forceps, 130mm

- 1 Straight surgical scissors, 130mm
- 1 Scalpel handle no. 4
- 1 Perforated metal case, consisting 6 scalpel blades BB 520
- 1 KOCHER haemostatic forceps, 130mm
- 1 Skin hook
- 1 MATHIEU needle holder, 140mm
- 1 Tube of suture skin, sterile in alcohol
- 1 MICHEL clip forceps, 120mm

- 25 MICHEL clip, 16 x 3mm
- 1 Perforated metal case, stainless, consisting:
- 1 Suture needle
- 1 item
- 1 item

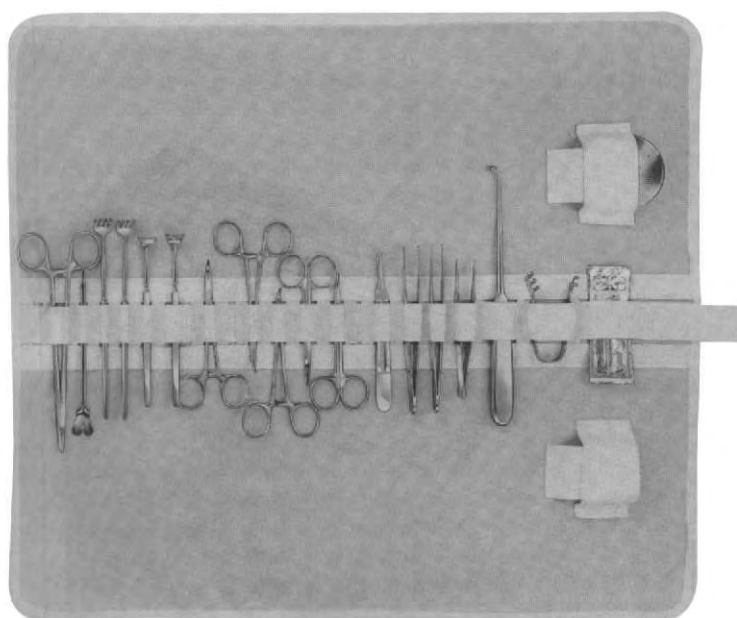

## 07-294

Venae sectio set, in sterilizable canvas roll consisting of:

- 1 Tissue forceps, 1 x 2 teeth, 140mm
- 1 Dissecting forceps, 145mm
- 1 FEILCHENFELD straight scissors, sharp, 110mm
- 1 curved scissors, blunt, 115mm
- 1 HALSTED mosquito forceps, curved on flat, 125mm

- 1 DESCHAMPS needle, blunt, 210mm
- 1 DOYEN Director, curved, 140mm
- 2 Wound retractors, 4 blunt prongs, 160mm
- 2 DESMARRES wound retractors, 135mm
- 1 FINSEN retractors, 2 x3 blunt prongs, 80mm

- 1 Scalpel handle no. 4
- 4 Sterile scalpel blades, no 18, single peel pack
- 1 Needle box, perforated, round, diam. 65mm
- 1 HEGAR-MAYO DUROGRIP needle holder, 180mm



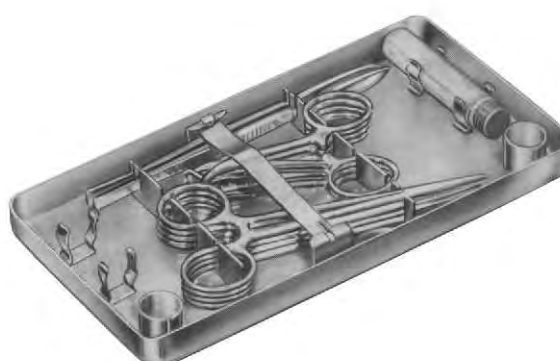

## 07-295

Venae sectio set, in metal case

consisting of:

### Bottom tray

- 1 MATHIEU needle holder, fine pattern 140mm
- 1 Ligature needle, fine short pattern
- 1 DOYEN director, curved
- 1 HEGENBARTH clip forceps,
- 1 ELSCHNIG tissue forceps, 1 x 2 teeth fine, 150mm
- 1 Dressing forceps, fine 105mm
- 1 Tissue forceps, 1 x 2 teeth, 110mm
- 1 Vessel scissors, straight, with 1 ball point, 110mm
- 1 Vessel scissors, curved, pointed 105mm
- 1 FINSSEN retractor
- 1 Perforated needle case

### Top tray

- 1 Scalpel, pointed
- 1 Scalpel, bellied
- 2 HALSTED mosquito forceps, curved, 125mm
- 2 HALSTED mosquito forceps, straight, 1x 2 teeth, 125mm
- 3 BACKHAUS towel forceps, 90mm
- 2 Flacon holder

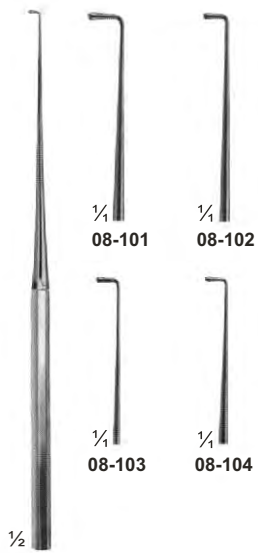

**08-101 - 104**  
WAGENER  
150 mm

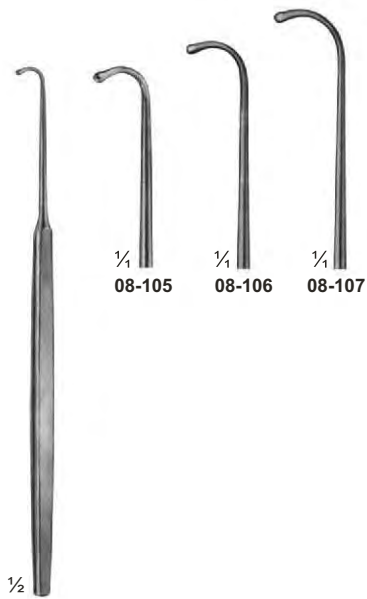

**08-105 - 107**  
GRAEFE  
140 mm



**08-108**  
BROM  
Vein hook  
170 mm



**08-109**  
CRILE  
200 mm



**08-110 - 111**  
CUSHING  
190 mm

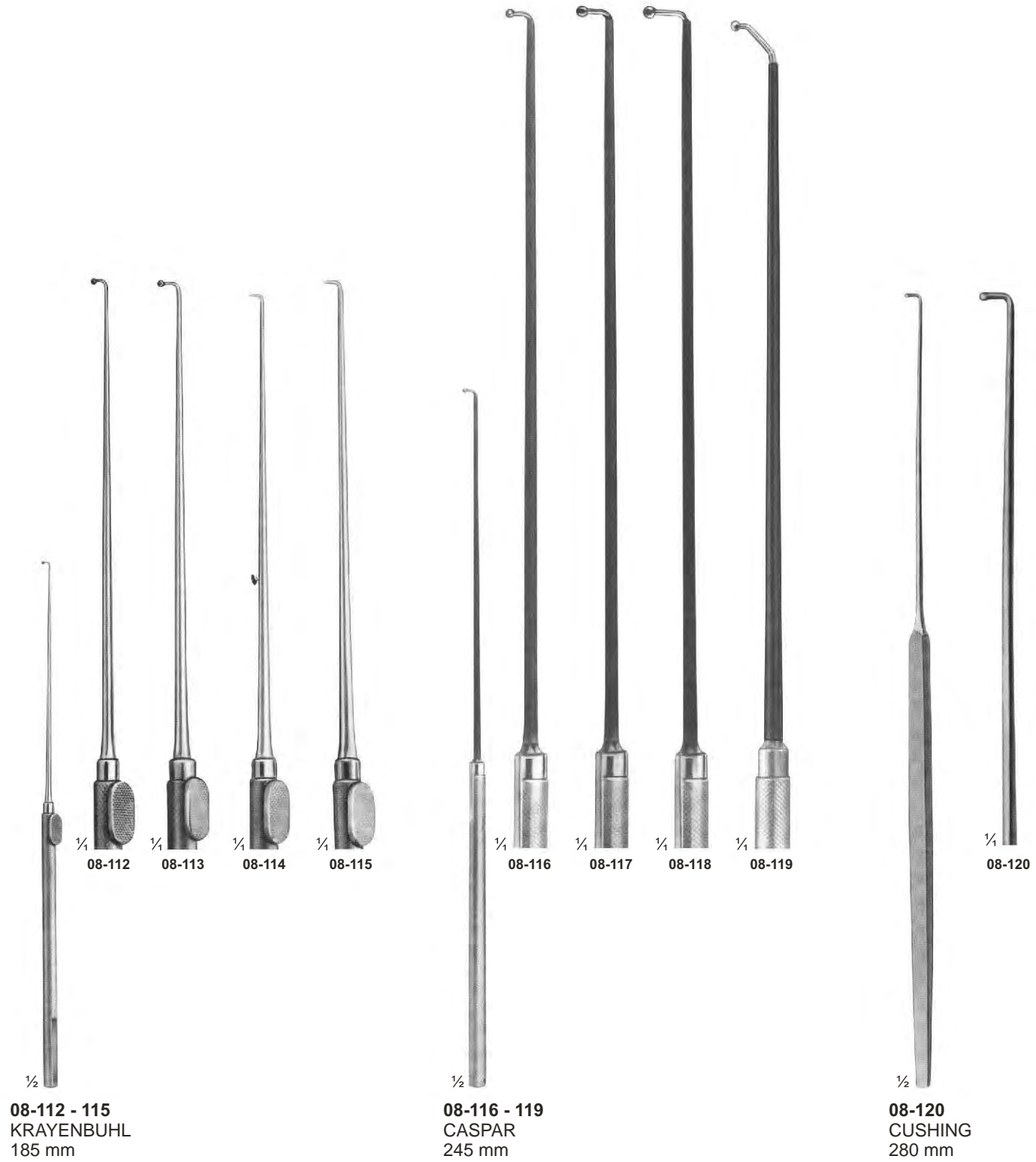

# Fine Wound Retractors (Dura- and Skin Retractors)

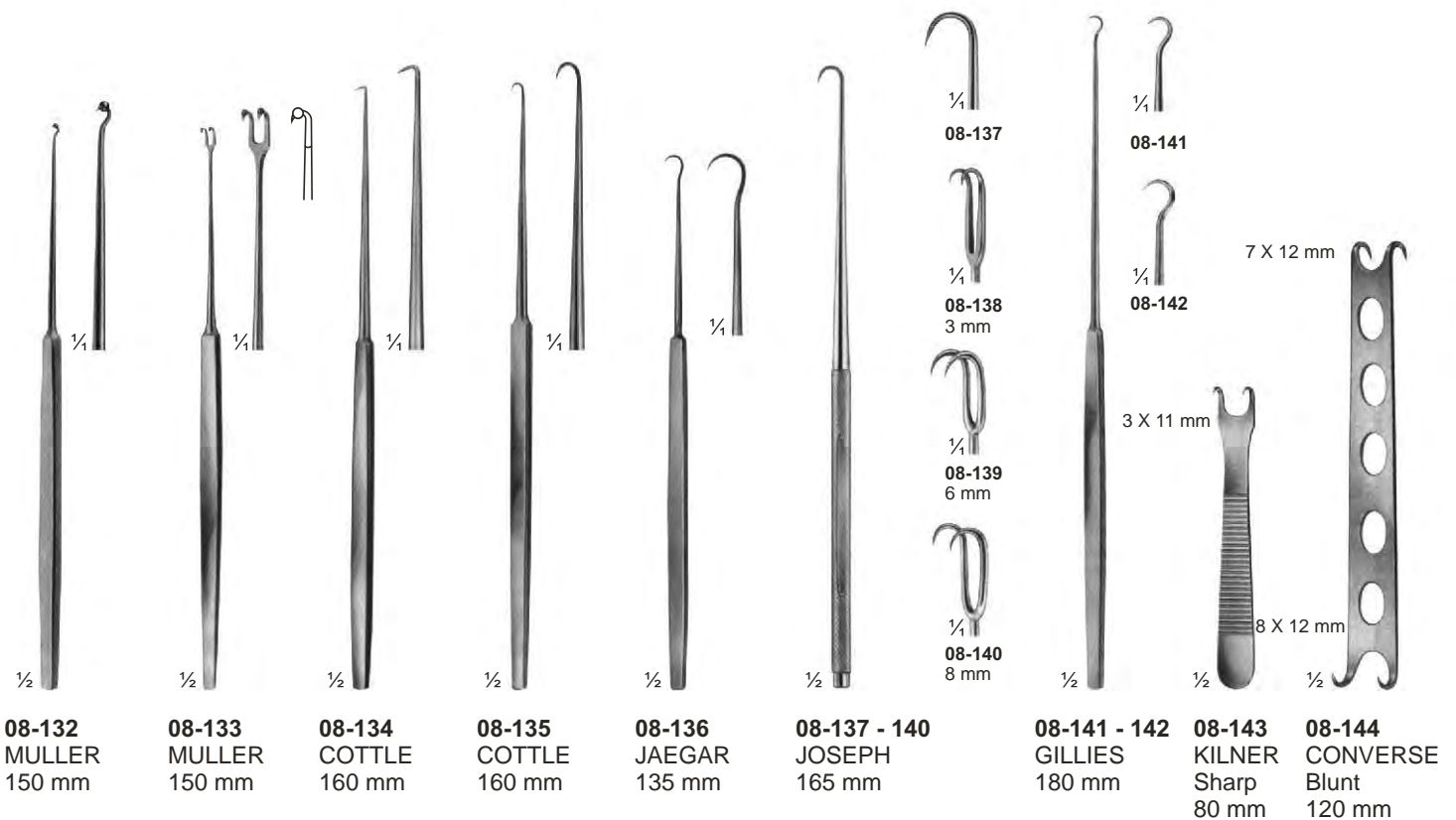
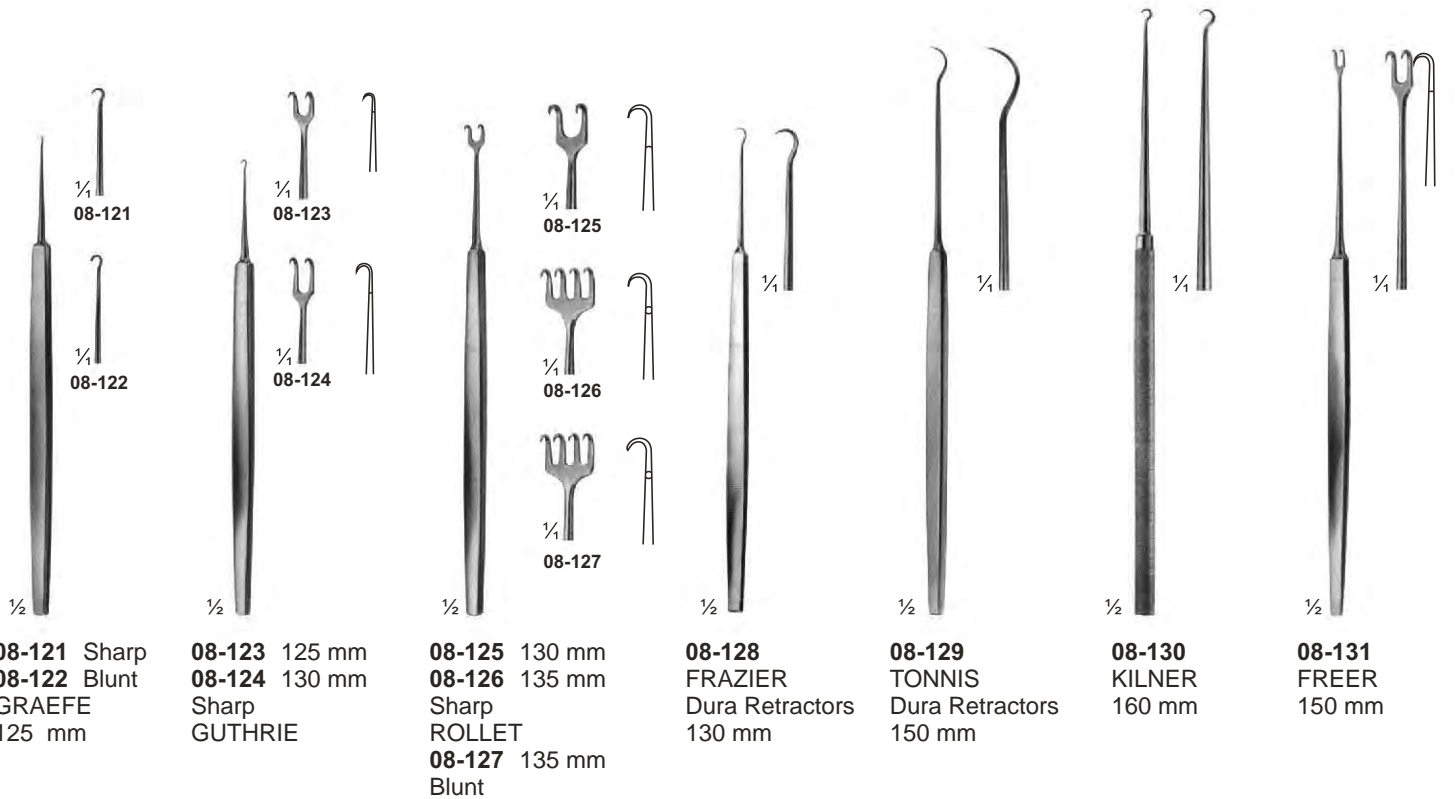



**08-145**  
BERGMANN  
140 mm

**08-146**  
BOSE  
165 mm

**08-147**  
BOSE  
165 mm

**08-148 - 150**  
180 mm

**08-151 - 153**  
Flexible shaft, sharp  
155 mm

**08-154 - 156**  
Flexible shaft, blunt  
155 mm

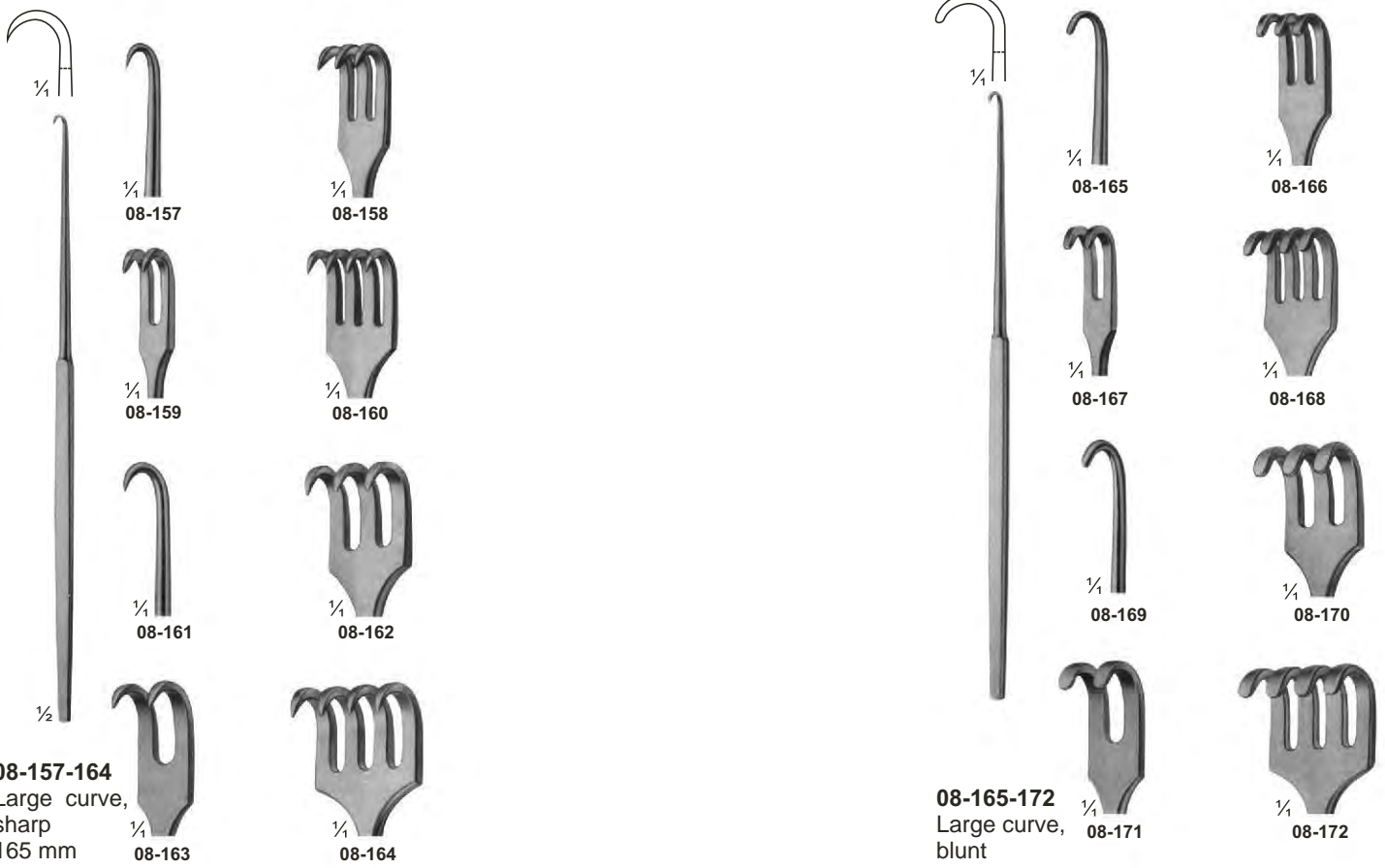

**08-157-164**  
Large curve,  
sharp  
165 mm

**08-165-172**  
Large curve,  
blunt  
165 mm



<p>1/2</p>	<p>1/4</p>	<p>1/4</p>	<p>1/2</p>	<p>1/4</p>	<p>1/4</p>
<p><b>08-173</b> MANNERFELT modif. sharp 135 mm</p>	<p><b>08-174</b> MANNERFELT modif. sharp 155 mm</p>	<p><b>08-175</b> MANNERFELT modif. sharp 155 mm</p>	<p><b>08-176 - 178</b> MANNERFELT modif. Small curve, sharp 155 mm</p>		<p><b>08-179 - 181</b> MANNERFELT modif. Large curve, blunt 155 mm</p>
<p>1/2</p>	<p>1/4</p>	<p>1/4</p>	<p>1/4</p>	<p><b>08-186</b> 12 x 12 mm</p>	<p><b>08-187</b> 12 x 14 mm</p>
<p><b>08-182 - 185</b> LANGENBECK- MANNERFELT modif. 155 mm</p>			<p><b>08-188</b> 14 x 16 mm</p>	<p><b>08-189</b> MANNERFELT modif. Saddle hooks, fenestrated 155 mm</p>	



08-190  
FOMON  
145 mm



08-191 - 192  
160 mm



08-193 - 194  
LANGENBECK-GREEN  
160 mm

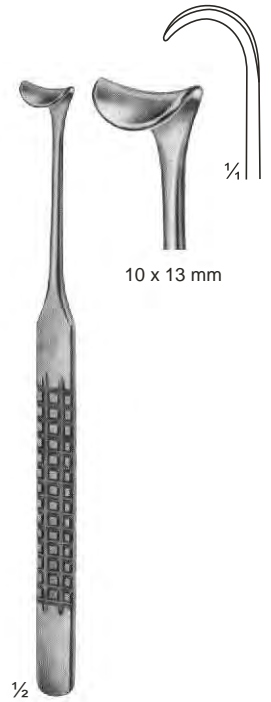

08-195  
160 mm



08-196 - 201  
MEYERDING  
Fig. A - Fig. F  
180 mm



A  
08-196  
18 x 7 mm

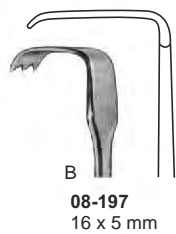

B  
08-197  
16 x 5 mm

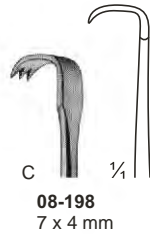

C  
08-198  
7 x 4 mm

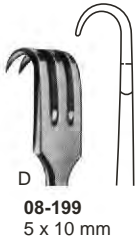

D  
08-199  
5 x 10 mm



E  
08-200  
11 x 4 mm



F  
08-201  
6 x 4 mm

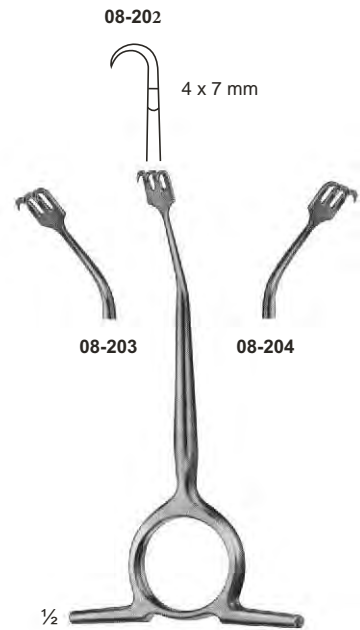

08-202 - 204  
WILLIGER  
120 mm



**08-205**  
EMMET  
Fistula hook  
220 mm



**08-206**  
SIMON  
Fistula hook  
220 mm

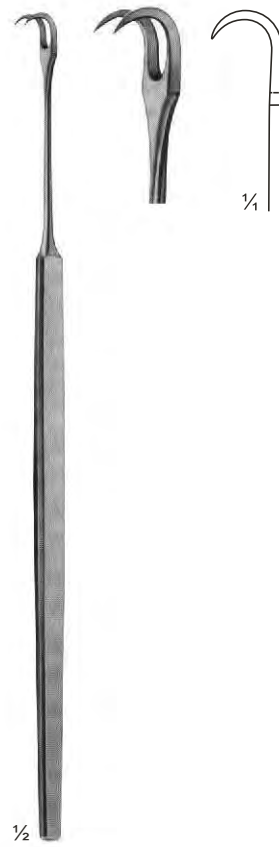

**08-207**  
SIMON  
Fistula hook  
220 mm



**08-208**  
LANGE  
Fistula hook  
230 mm

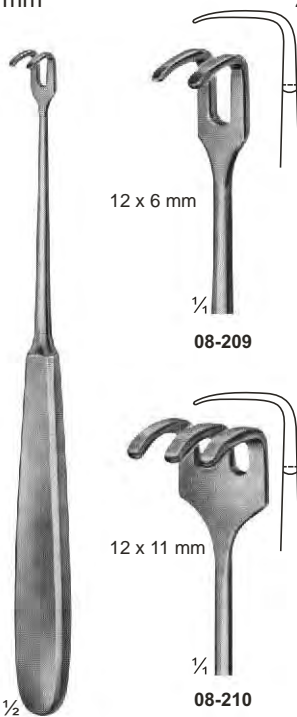

**08-209 - 210**  
Tendon hooks  
175 mm

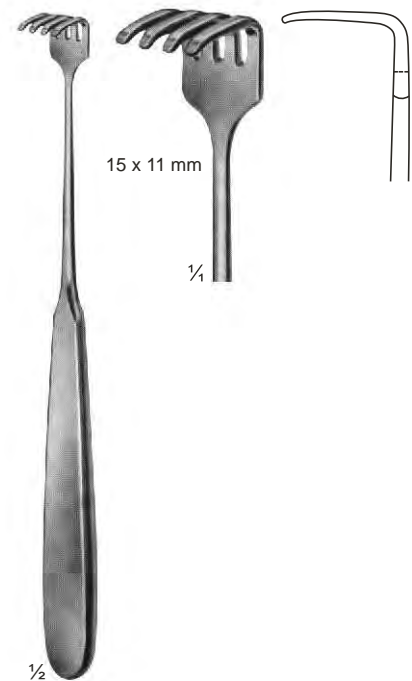

**08-211**  
KLAPP  
Tendon hooks  
175 mm

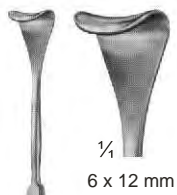

1/2  
**08-212**  
MASING  
140 mm

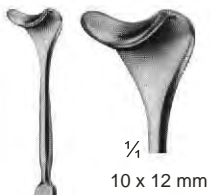

1/2  
**08-213**  
COTTLE  
140 mm



1/2  
**08-214 - 218**  
DESMARRES  
140 mm



1/4  
**08-215**  
9 x 12 mm



1/4  
**08-216**  
11 x 14 mm



1/4  
**08-217**  
12 x 16 mm



1/4  
**08-218**  
13 x 18 mm

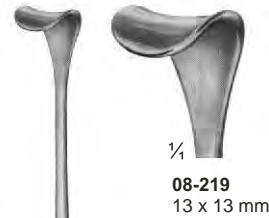

1/4  
**08-219**  
13 x 13 mm



1/4  
**08-220**  
12 x 16 mm

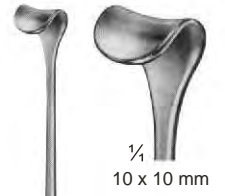

1/4  
10 x 10 mm

1/2  
**08-219 - 220**  
KONIG  
180 mm

1/2  
**08-221**  
CUSHING-KOCHER  
175 mm

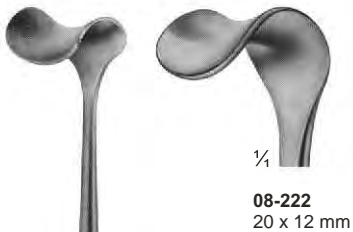

1/4  
**08-222**  
20 x 12 mm

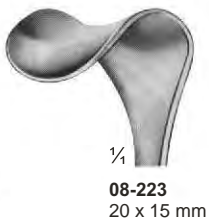

1/4  
**08-223**  
20 x 15 mm



1/4  
13 x 6 mm



1/4  
**08-225**  
10 x 13 mm



1/4  
**08-226**  
14 x 18 mm

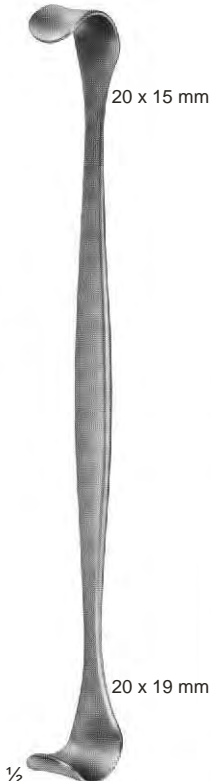

1/2  
**08-227**  
205 mm

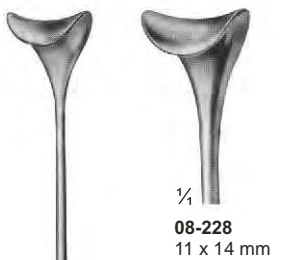

1/4  
**08-228**  
11 x 14 mm



1/4  
**08-229**  
13 x 18 mm

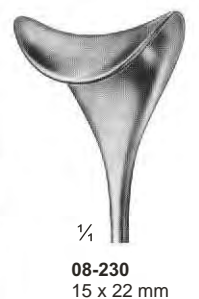

1/4  
**08-230**  
15 x 22 mm

1/2  
**08-228 - 230**  
CUSHING  
250 mm

1/2  
**08-222 - 223**  
KOCHER  
205 mm

1/2  
**08-224**  
SCHOENBORN  
200 mm

1/2  
**08-225 - 226**  
CUSHING  
205 mm



**08-231 - 232**  
BABY-SENN-MILLER  
155 mm

**08-233**  
SENN-MILLER  
165 mm

**08-234**  
COLLIN-HARTMANN  
150 mm

**STERBERG**  
**08-235** 120 mm  
**08-236** 130 mm  
**08-237** 135 mm  
**08-238** 140 mm

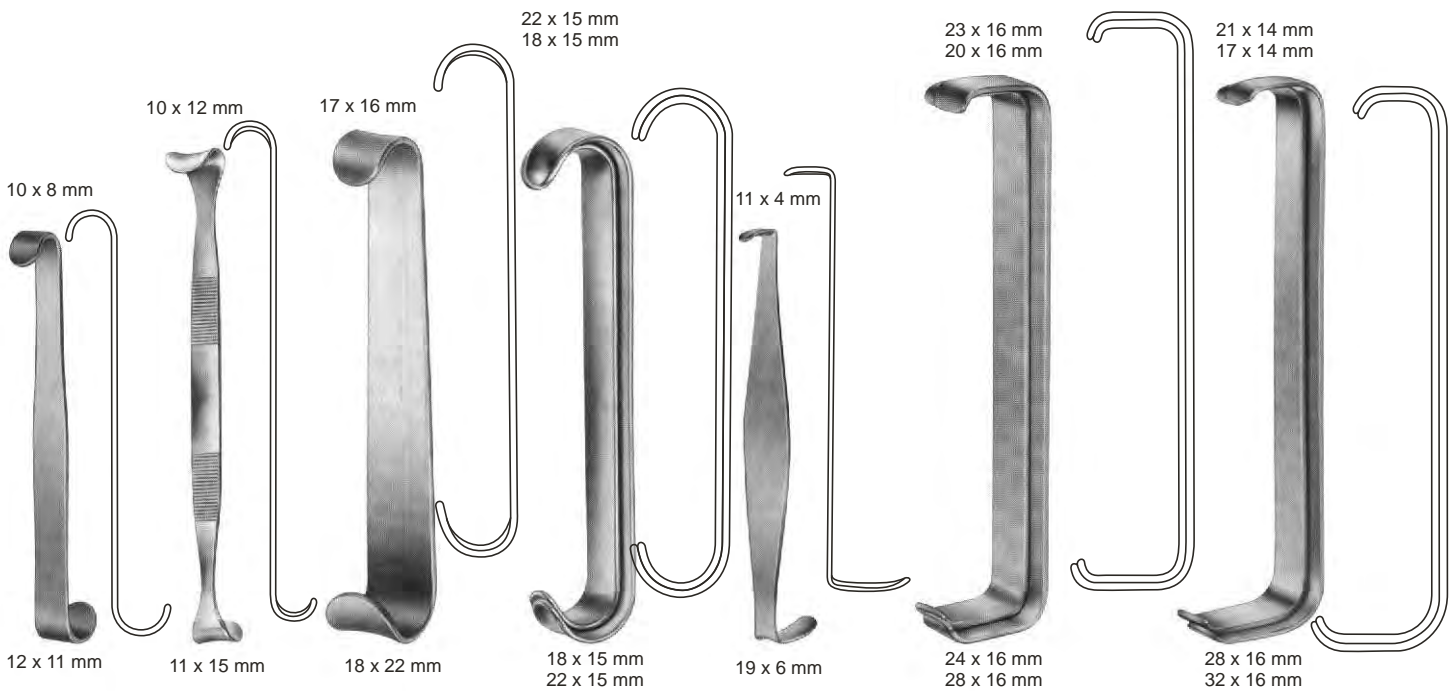

**08-239**  
LUER  
110 mm

**08-240**  
ROSE  
130 mm

**08-241**  
BABY-ROUX  
135 mm

**08-242**  
PARKER  
135 mm

**08-243**  
CRILE  
110 mm

**08-244**  
FARABEUF  
150 mm

**08-245**  
COLLIN  
150 mm

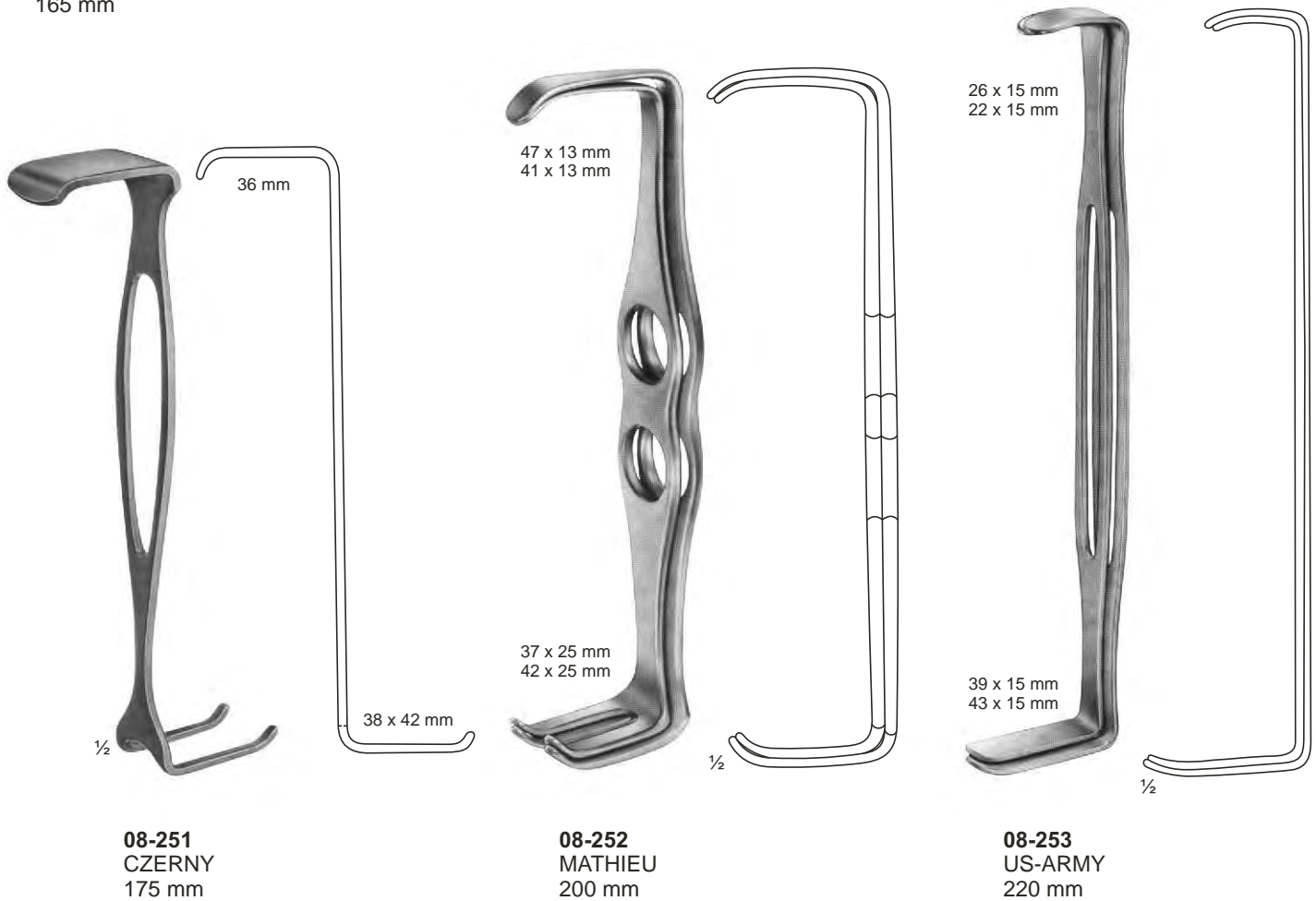
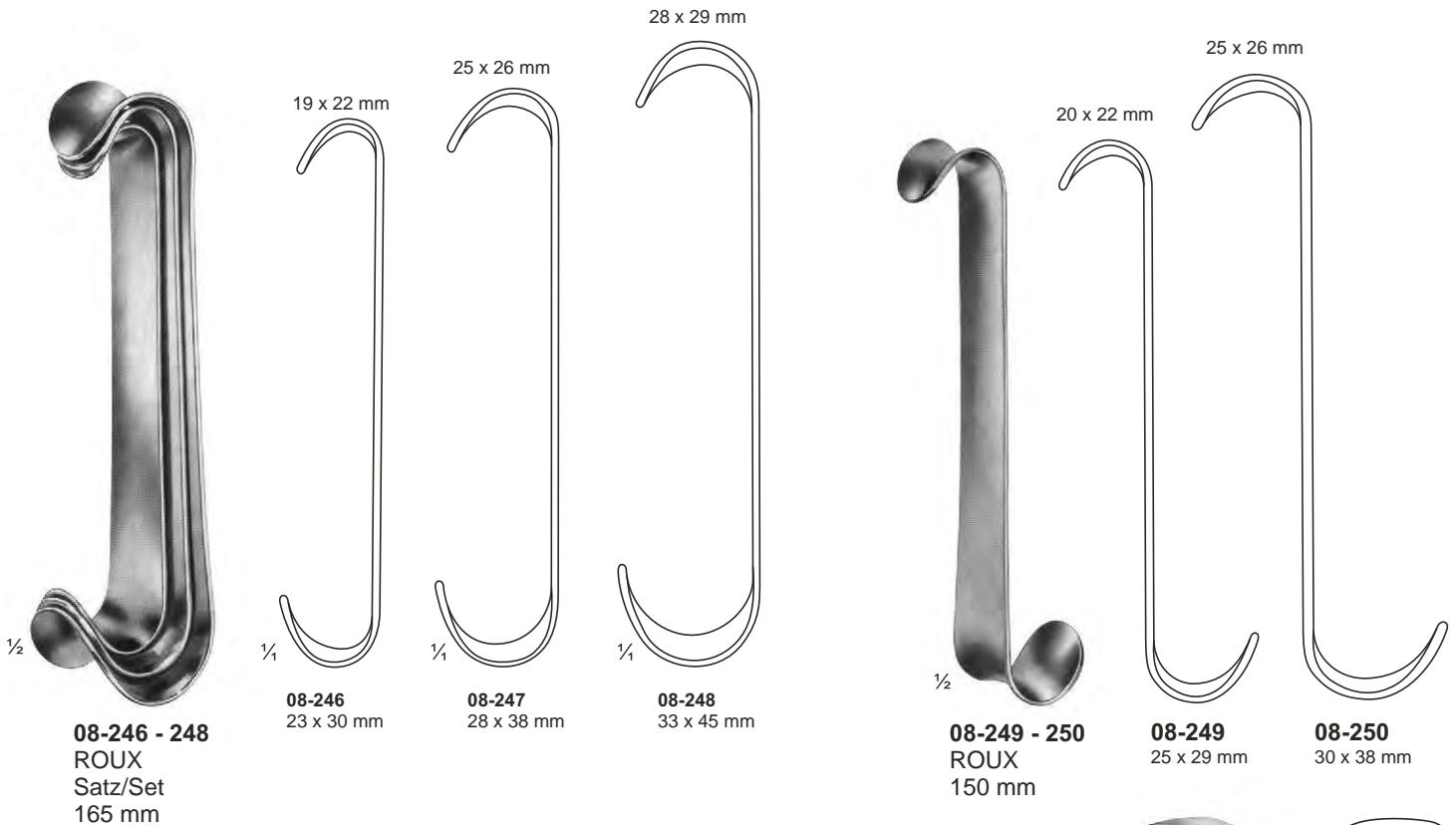



**08-254**  
KOCHER  
Sharp  
205 mm



**08-255**  
KOCHER  
Sharp  
220 mm



**08-256**  
KOCHER  
Blunt  
220 mm



**08-257**  
VOLKMANN  
Sharp  
220 mm



**08-258**  
VOLKMANN  
Sharp  
220 mm



**08-259 - 266**  
VOLKMANN  
225 mm

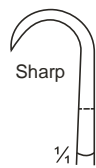

Sharp

1/4

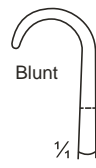

Blunt

1/4



**08-259**  
9 x 8 mm



**08-260**  
9 x 13 mm



**08-261**  
9 x 19 mm



**08-262**  
9 x 29 mm



**08-263**  
8,5 x 8 mm



**08-264**  
8,5 x 13 mm



**08-265**  
8,5 x 19 mm



**08-266**  
8,5 x 29 mm

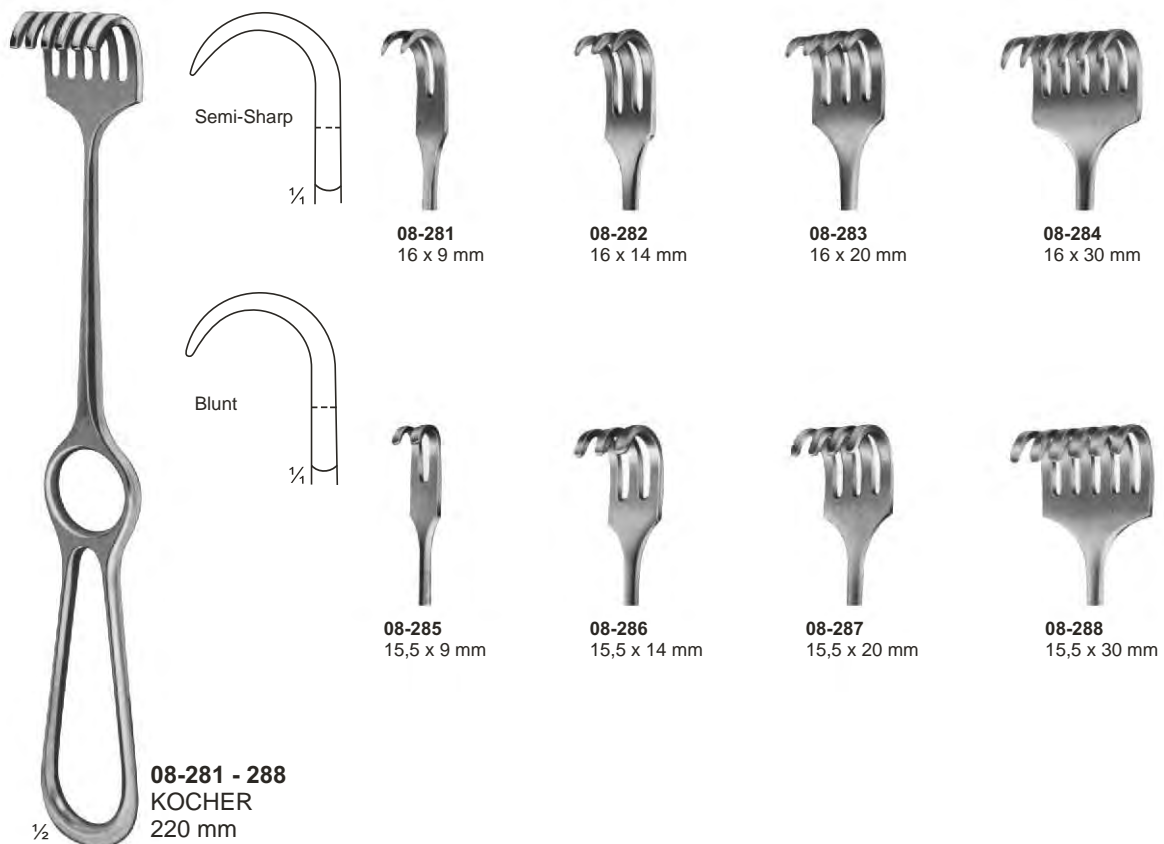
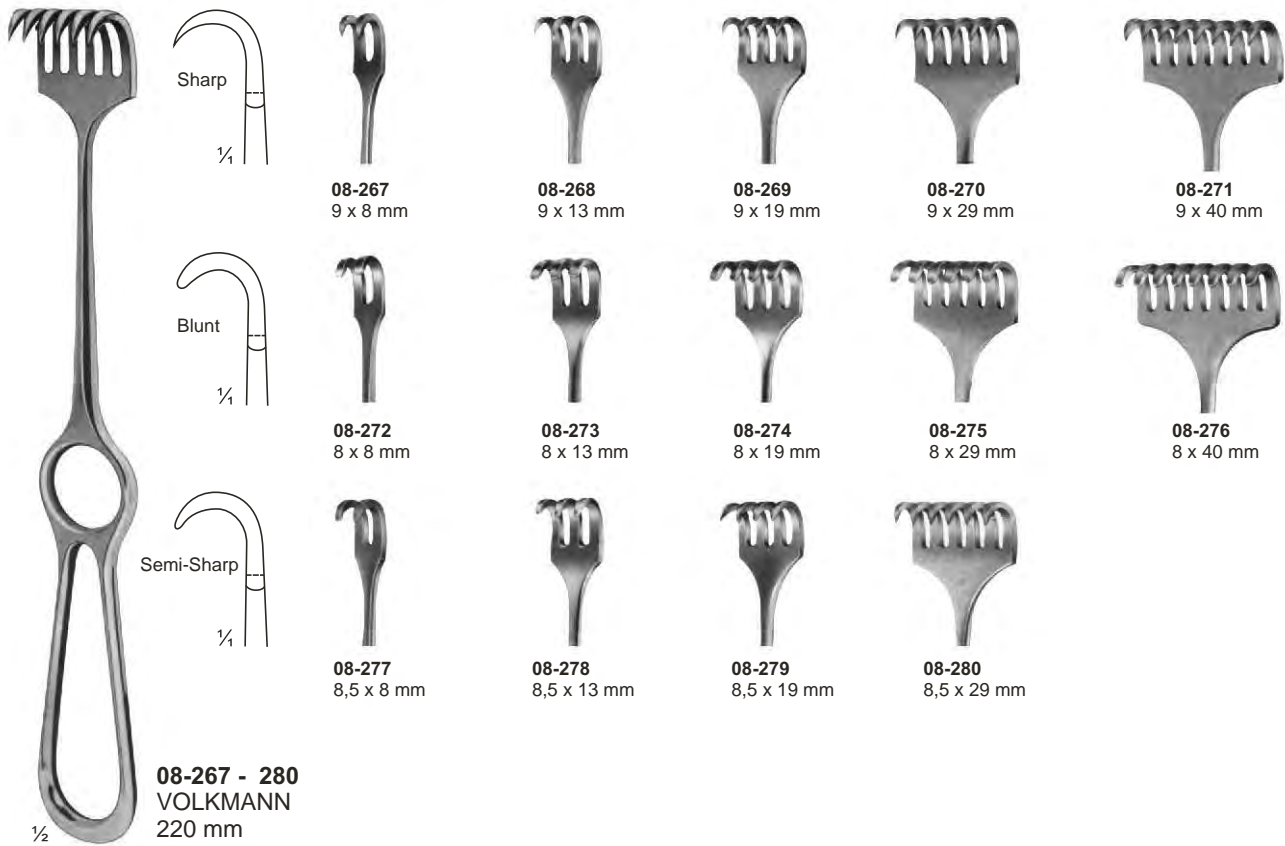



**08-289 - 290**  
KORTE  
240 mm



**08-289**  
8 Prongs, blunt



**08-290**  
8 Prongs, sharp



**08-291 - 294**  
ISRAEL  
255 mm

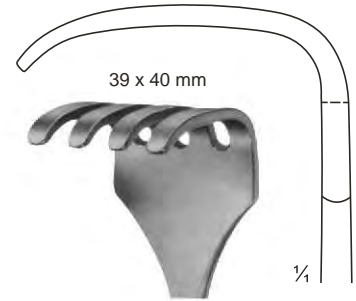

**08-291**  
4 Prongs, blunt

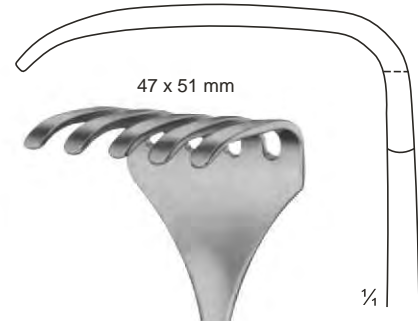

**08-292**  
5 Prongs, blunt

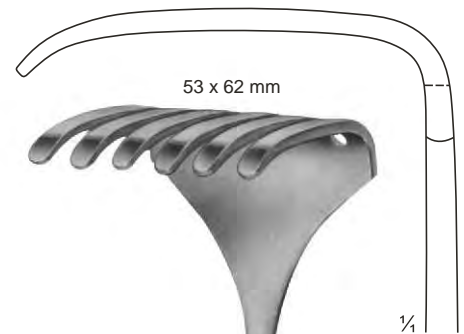

**08-293**  
6 Prongs, blunt

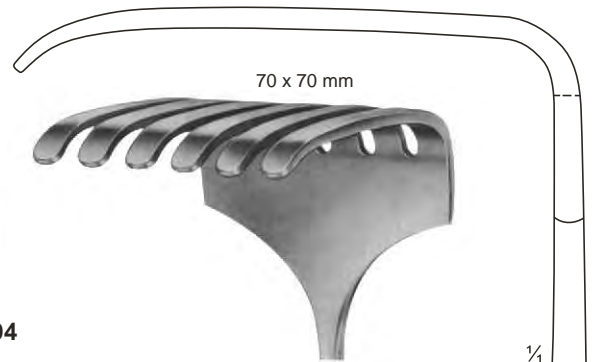

**08-294**  
6 Prongs, blunt



1/2

**08-309 - 313**  
KOCHER  
230 mm



1/2

**08-314 - 316**  
SAUERBRUCH  
225 mm

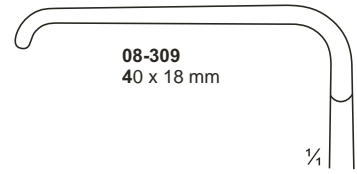

**08-309**  
40 x 18 mm

1/4

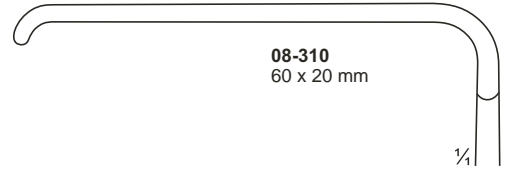

**08-310**  
60 x 20 mm

1/4

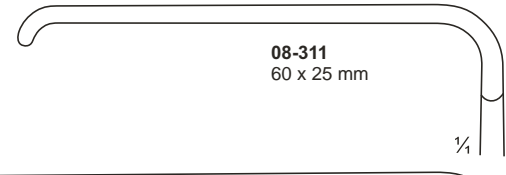

**08-311**  
60 x 25 mm

1/4



**08-312**  
75 x 30 mm

1/4

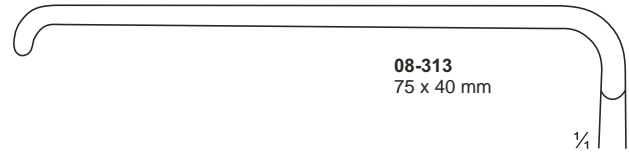

**08-313**  
75 x 40 mm

1/4

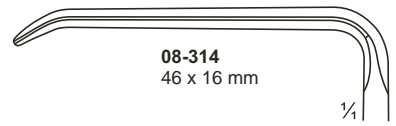

**08-314**  
46 x 16 mm

1/4

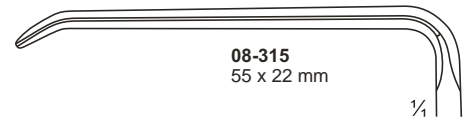

**08-315**  
55 x 22 mm

1/4

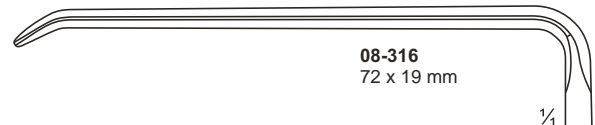

**08-316**  
72 x 19 mm

1/4

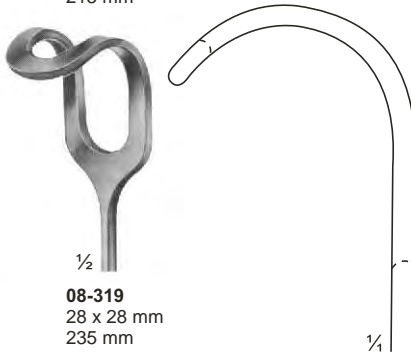
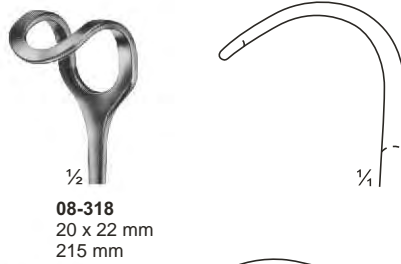

**08-317 - 319**  
MIDDELDORPF



**08-320**  
BUCHS  
205 mm



**08-321**  
CASPAR  
210 mm

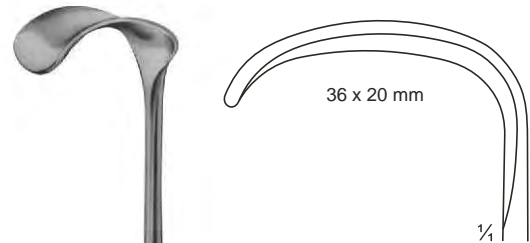

**08-322**  
KOCHER  
230 mm



**08-323 - 328**  
HOSEL  
250 mm

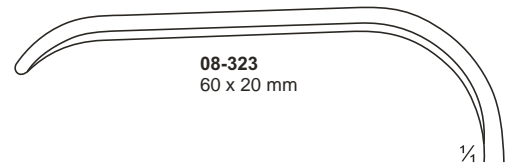

**08-323**  
60 x 20 mm

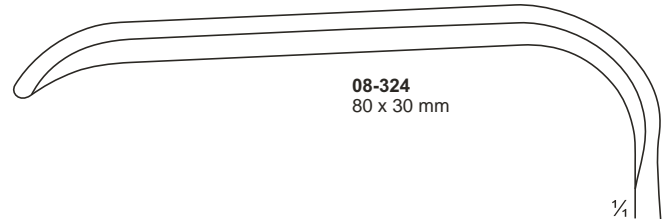

**08-324**  
80 x 30 mm

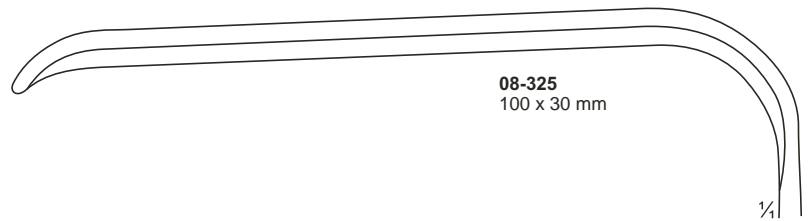

**08-325**  
100 x 30 mm

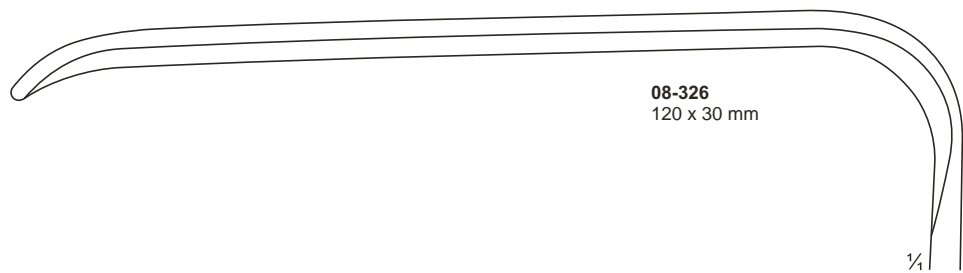

**08-326**  
120 x 30 mm

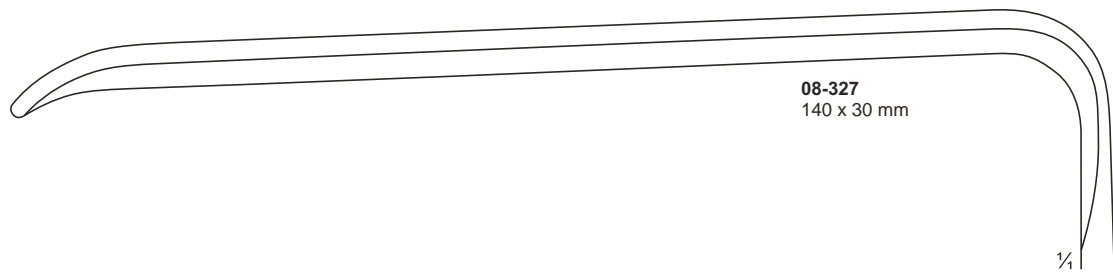

**08-327**  
140 x 30 mm

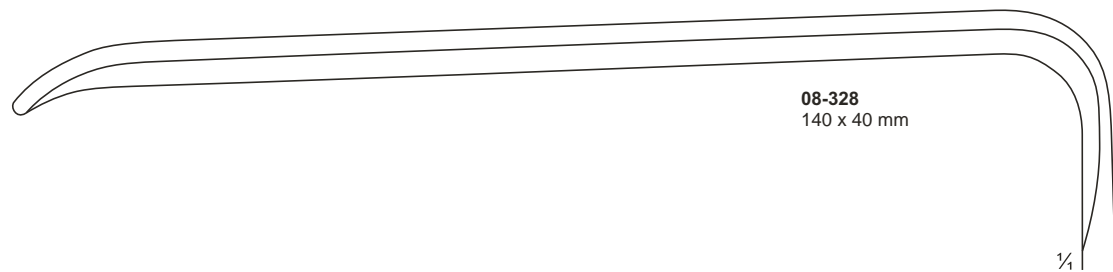

**08-328**  
140 x 40 mm



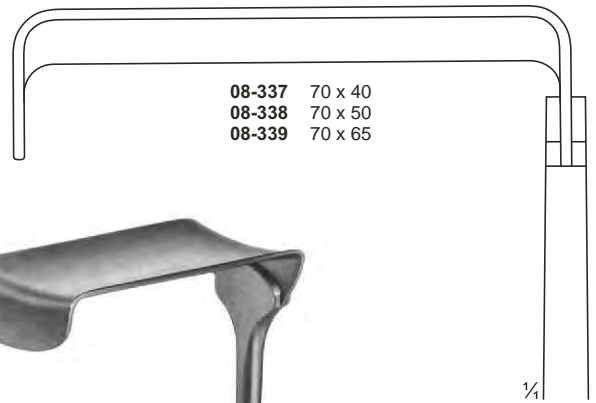
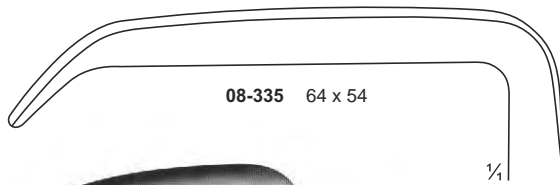
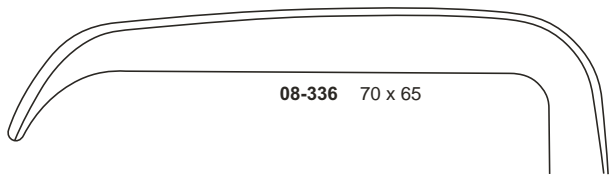

**08-335 - 336**  
KELLY  
260 mm



**08-337 - 339**  
MORRIS  
245 mm







- 08-347 - 353**  
BRUNNER  
275 mm
- 08-347 80 x 20
  - 08-348 100 x 25
  - 08-349 120 x 25
  - 08-350 130 x 30
  - 08-351 140 x 30
  - 08-352 160 x 30
  - 08-353 180 x 30

1/2



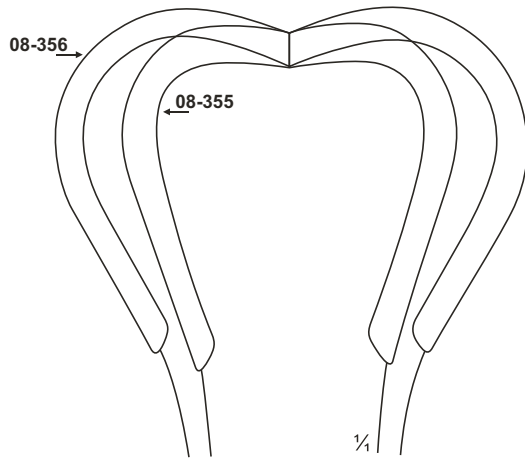

**08-355 - 356**  
**HARRINGTON**  
**08-355** 123 x 45 mm  
**08-356** 123 x 64 mm  
 Flexible  
 295 mm



**08-357**  
**ALLISON**  
 255 mm



**08-358**  
**ALLISON**  
 320 mm



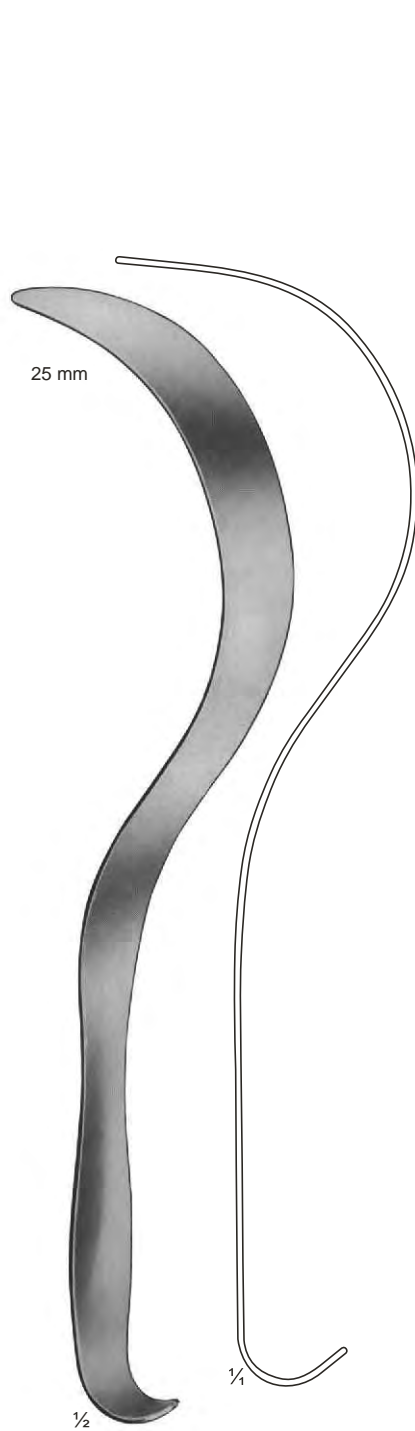

**08-364**  
DEAVER  
300 mm  
Fig. 1



**08-365**  
DEAVER  
315 mm  
Fig. 2

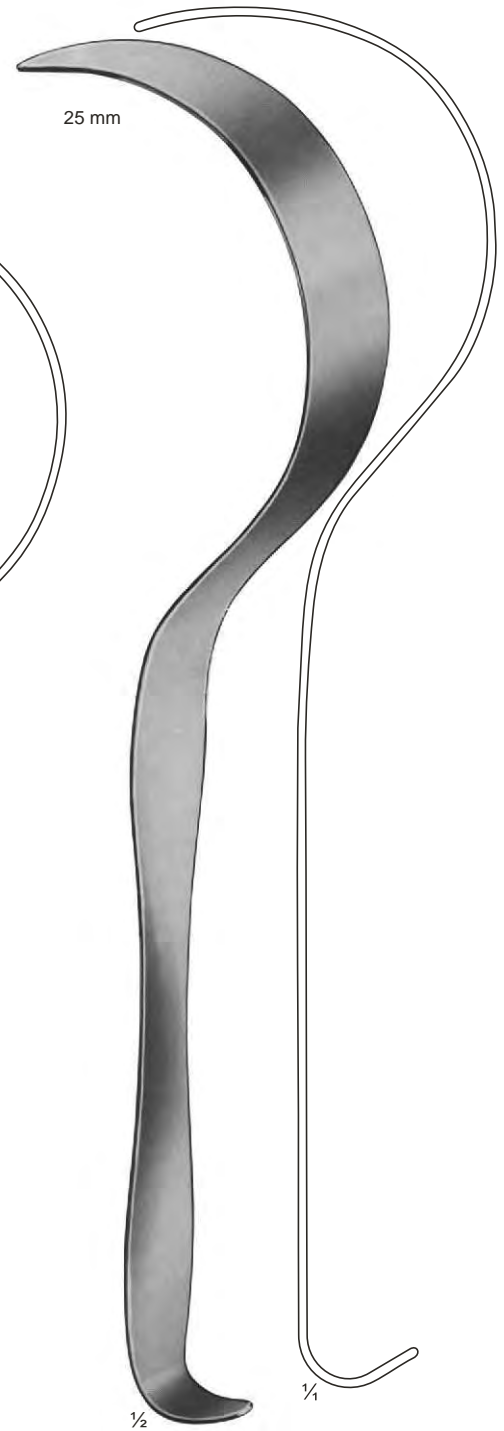

**08-366**  
DEAVER  
365 mm  
Fig. 2



**08-367**  
DEAVER  
300 mm  
Fig. 3

**08-368**  
DEAVER  
310 mm  
Fig. 4

**08-369**  
DEAVER  
320 mm  
Fig. 5

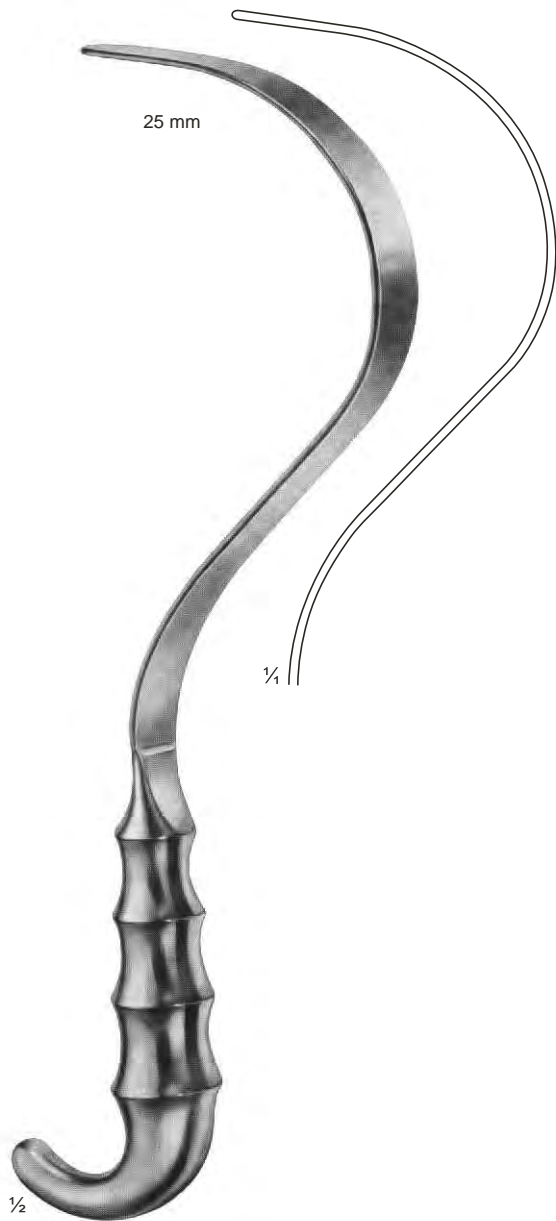

**08-370**  
DEAVER  
310 mm  
Fig. 1

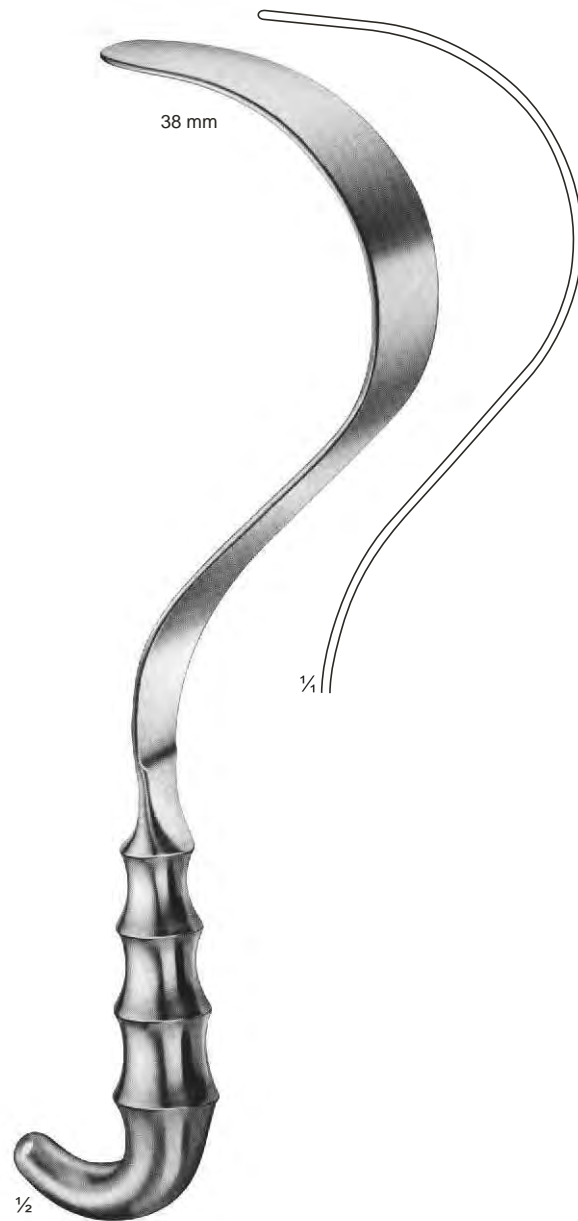

**08-371**  
DEAVER  
310 mm  
Fig. 3

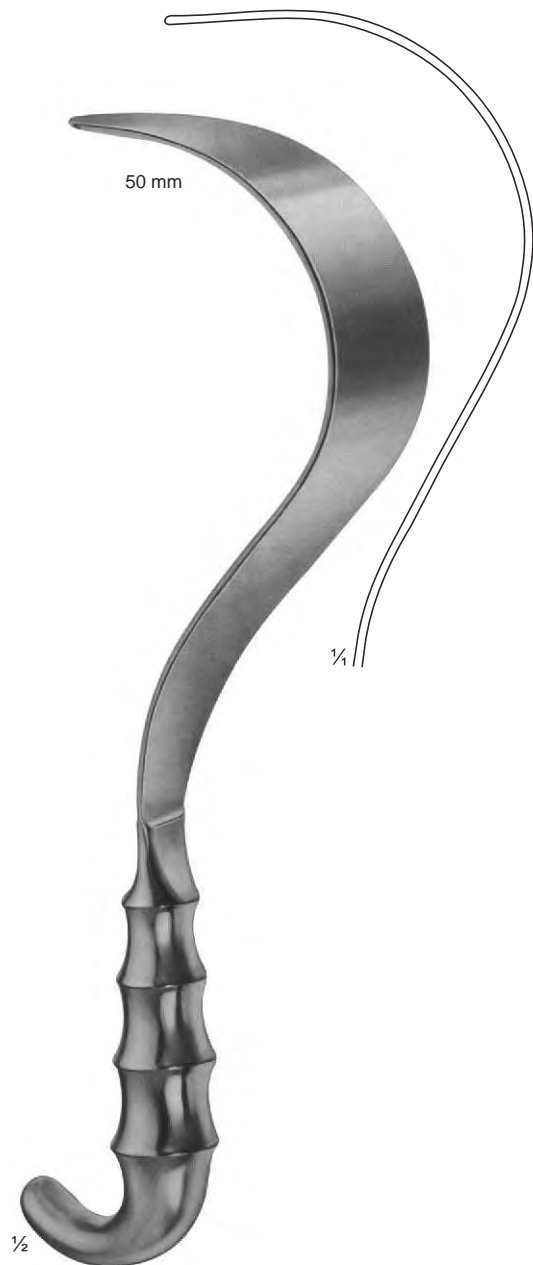

**08-372**  
DEAVER  
305 mm  
Fig. 3

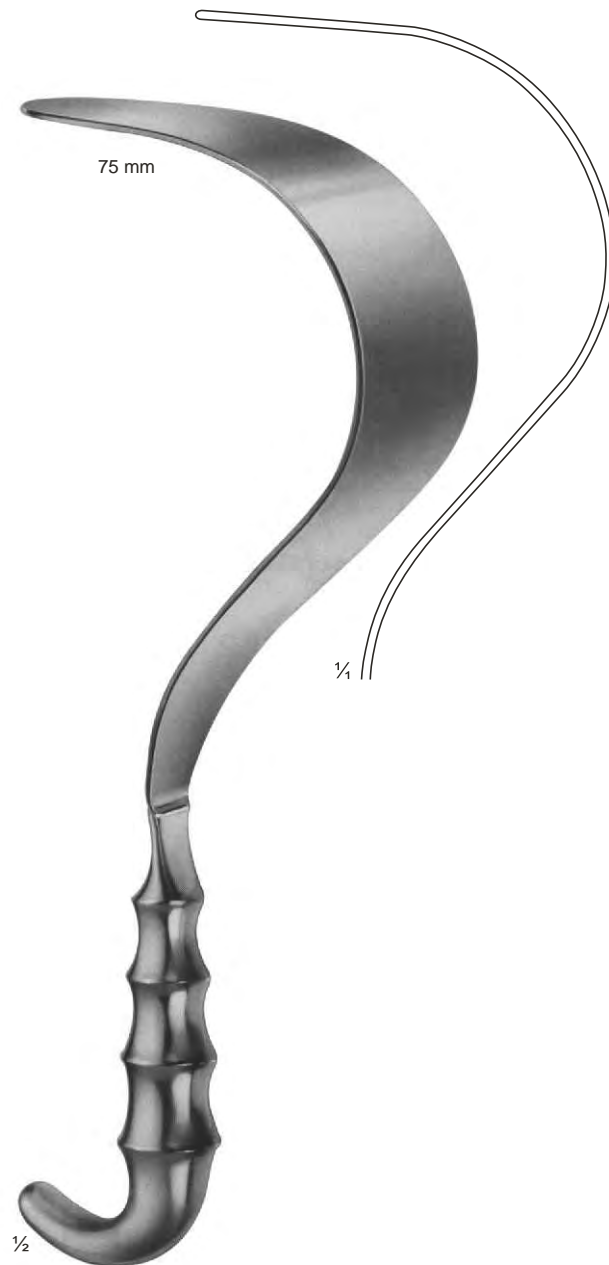

**08-373**  
DEAVER  
310 mm  
Fig. 4

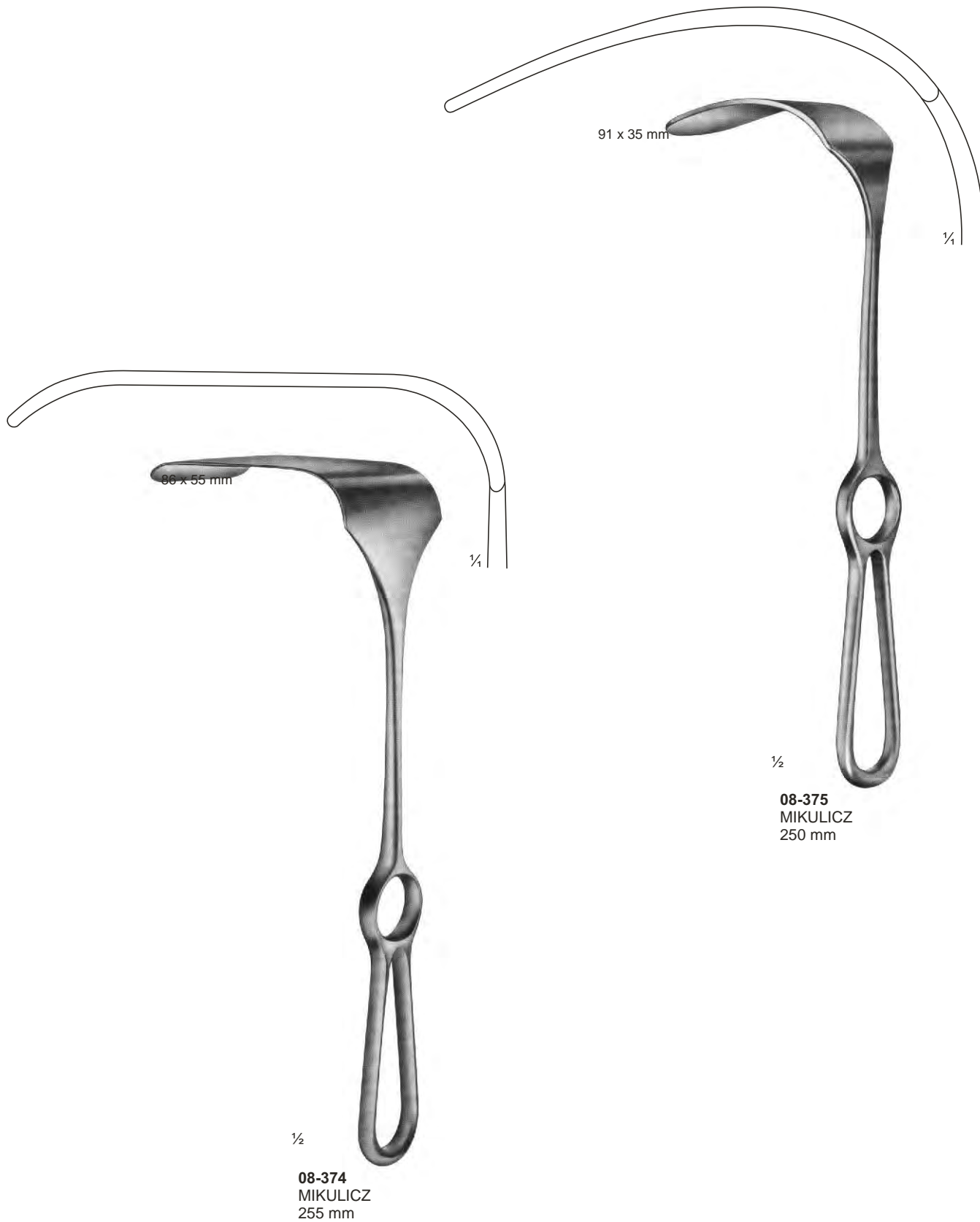

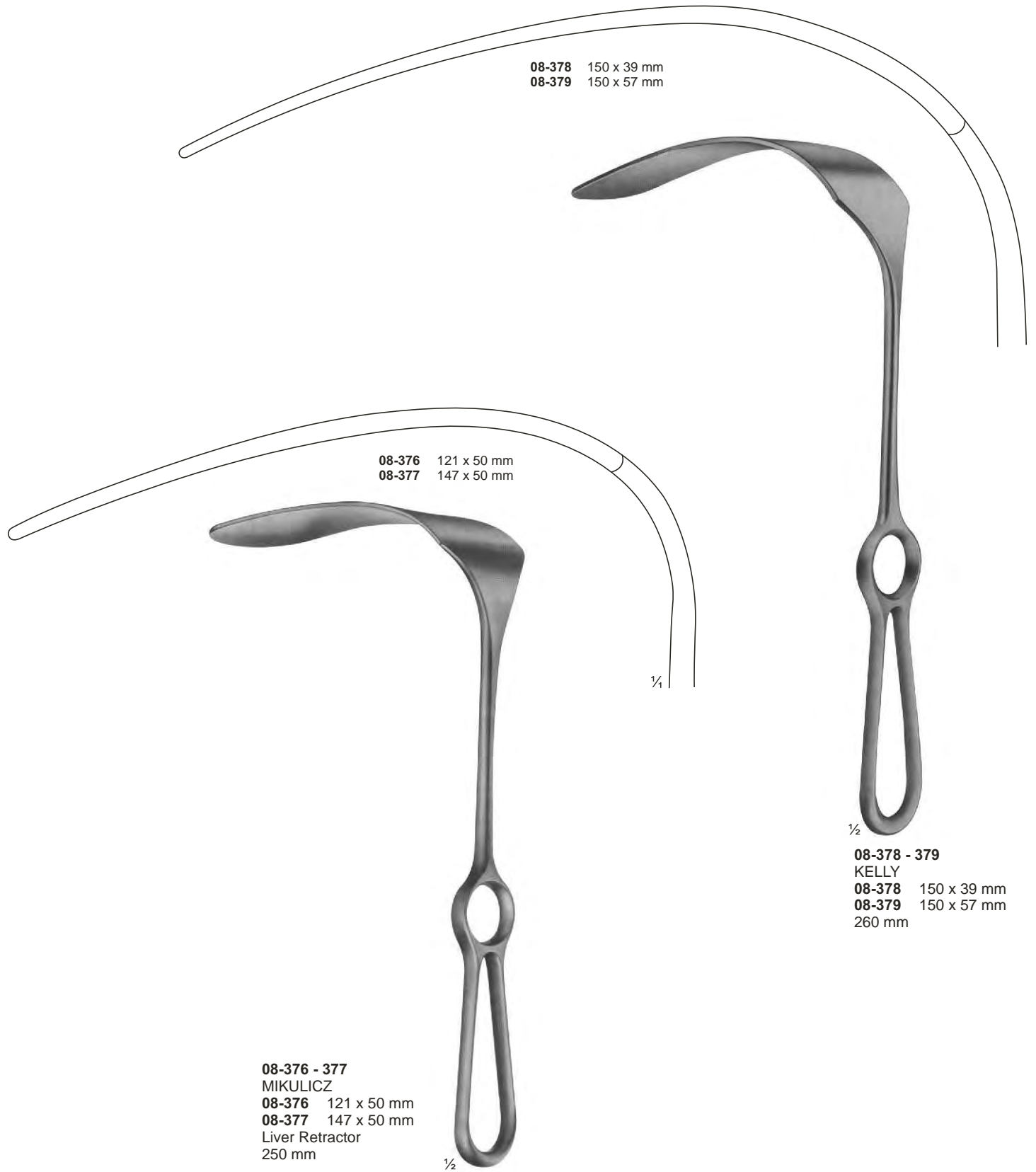

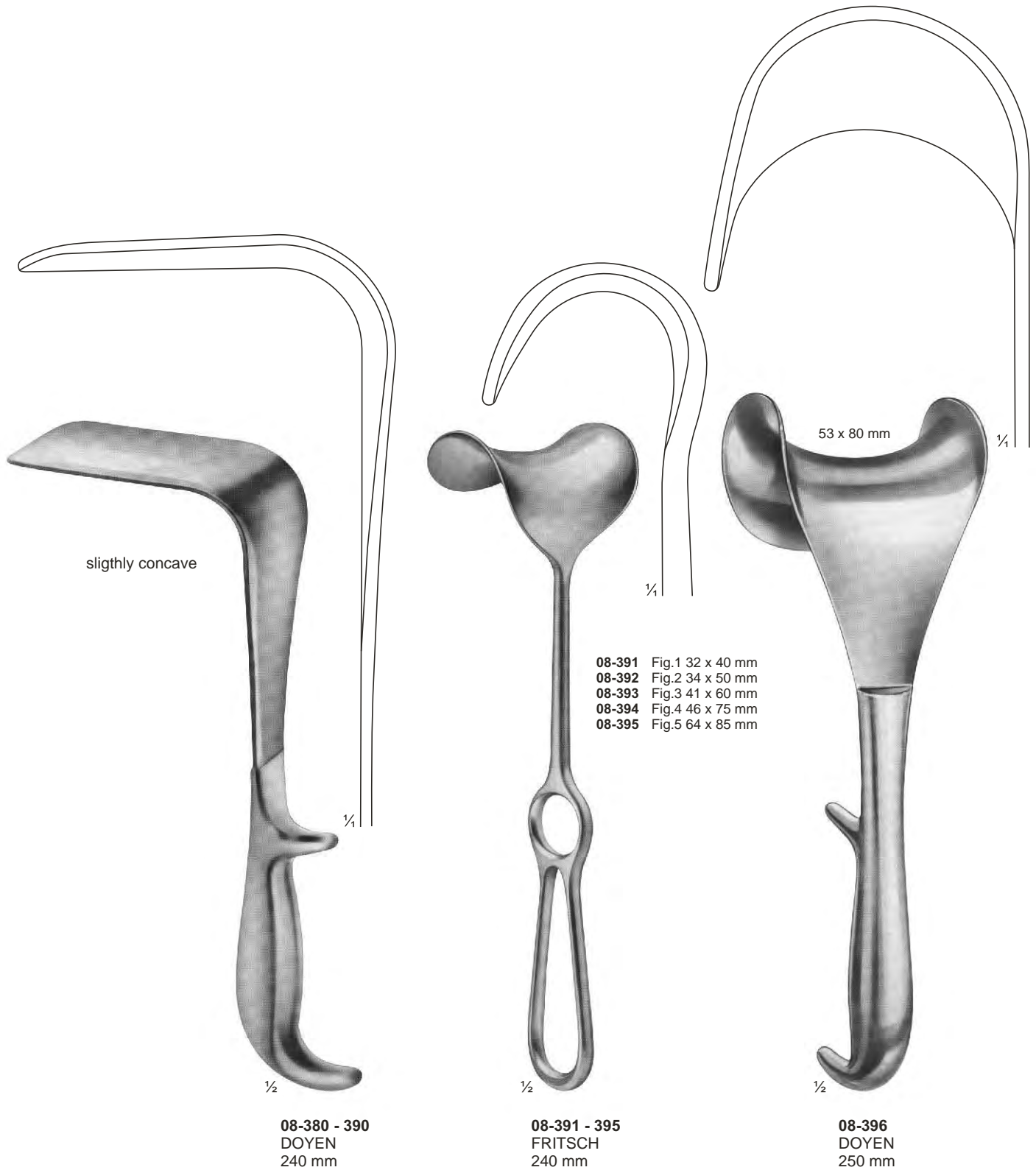

- 08-391 Fig.1 32 x 40 mm
- 08-392 Fig.2 34 x 50 mm
- 08-393 Fig.3 41 x 60 mm
- 08-394 Fig.4 46 x 75 mm
- 08-395 Fig.5 64 x 85 mm

**08-380 - 390**  
DOYEN  
240 mm

**08-391 - 395**  
FRITSCH  
240 mm

**08-396**  
DOYEN  
250 mm

	<b>Width of Blades</b>
	35 mm, 45 mm, 60 mm
<b>Length of Blades</b>	
62 mm	<b>08-380 , 08-381 , 08-382</b>
92 mm	<b>08-383 , 08-384 , 08-385</b>
122 mm	<b>08-386 , 08-387 , 08-388</b>
160 mm	<b>08-389 , 08-390</b>



**08-397 - 401**  
**ROCHARD**  
 310 mm  
**08-397** 48 x 90 mm  
**08-398** 48 x 105 mm  
**08-399** 48 x 120 mm  
**08-400** 48 x 135 mm  
**08-401** 48 x 155 mm



**08-402**



**08-403 - 406**  
**DOYEN**  
 280 mm  
**08-403** 48 x 90 mm  
**08-404** 48 x 105 mm  
**08-405** 48 x 120 mm  
**08-406** 48 x 135 mm



**08-407**  
**DOYEN-CHILD**  
 Fixation device  
 220 mm



**08-408**  
 Chain with  
 weight (747 / 645g)  
 790 mm

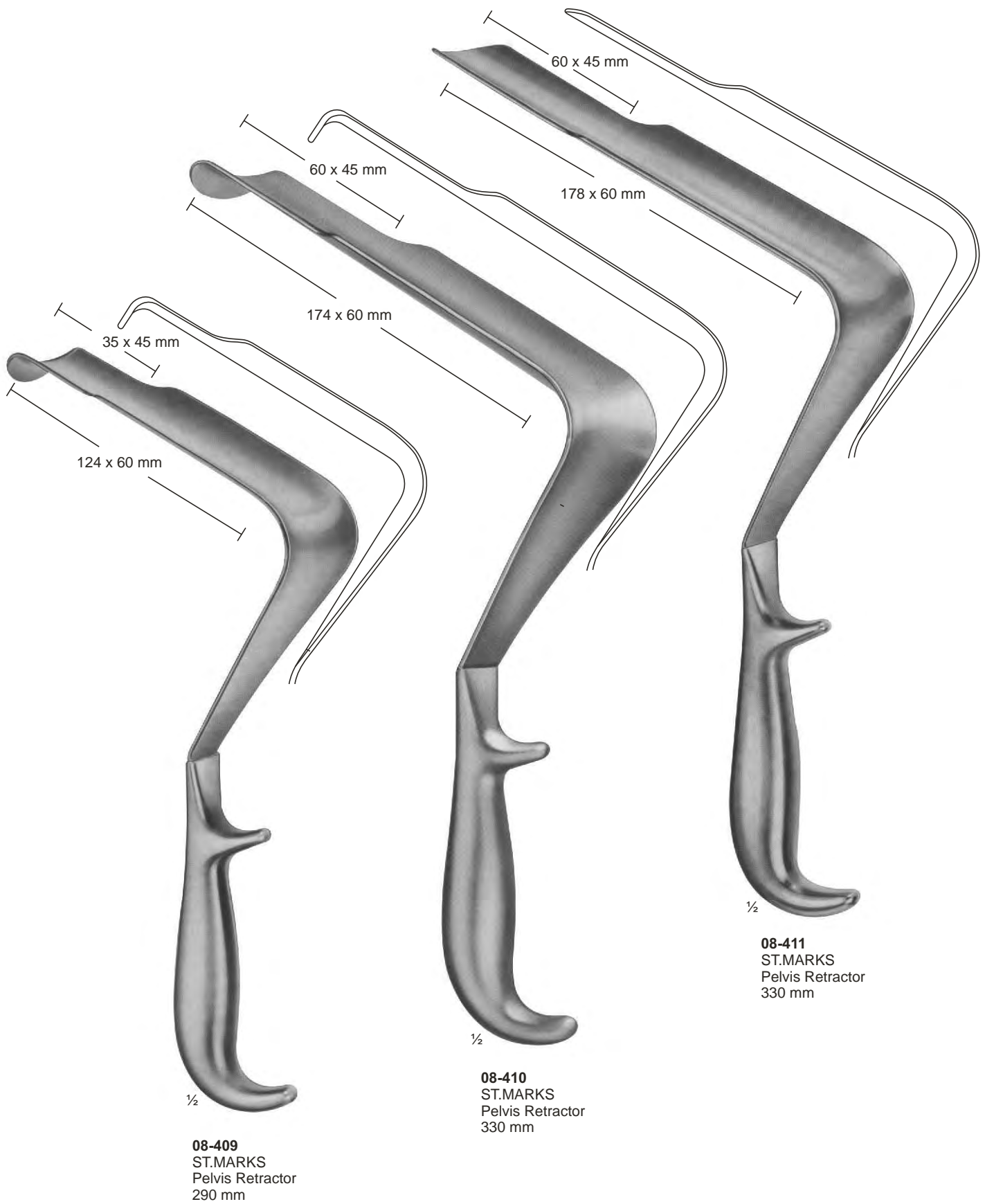



**08-412**  
LERICHE  
255 mm

**08-413**  
KUMMEL  
Melleable  
285 mm

**08-414**  
MIKULICZ  
29 mm  
250 mm

**08-415 - 416**  
KADER  
**08-415** 30 mm  
**08-416** 40 mm  
270 mm



45 mm  
**08-417**  
 REVERDIN  
 285 mm



50 mm  
**08-418**  
 HABERER  
 Malleable  
 305 mm



30 mm  
**08-419**  
 40 mm  
**08-420**  
 50 mm  
**08-421**  
 Malleable  
 330 mm



25 mm  
**08-422**  
 TUFFIER  
 Melleable  
 200 mm



**08-423**  
BOSE  
60 mm



**08-424**  
FINSEN  
50 mm



**08-425**  
FINSEN  
70 mm



**08-426**  
FINSEN modif.  
75 mm



**08-427**  
45 mm



**08-428**  
55 mm



**08-429**  
MUELLER  
65 mm



**08-430**  
100 mm



**08-431**



**08-432**



**08-431 - 432**  
ALM  
**08-431** 70 mm  
**08-432** 100 mm



**08-433**  
LOGAN  
modif. REILL  
50 mm

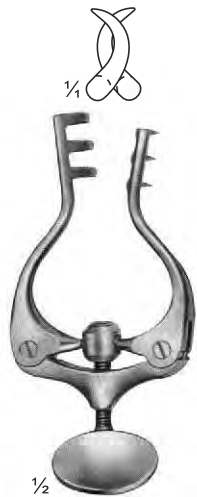

**08-434**  
JANSEN  
100 mm



**08-435**  
JANSEN  
100 mm

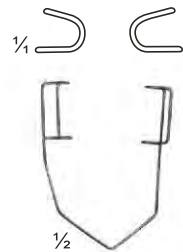

**08-436**  
BARRAQUER  
45 mm



**08-437**  
WEITLANER  
Sharp  
110 mm



**08-438**  
WEITLANER  
Semi-Sharp  
110 mm



**08-439**  
WEITLANER  
Blunt  
110 mm



**08-440**  
WEITLANER  
Sharp  
130 mm



**08-441**  
WEITLANER  
Semi-Sharp  
130 mm



**08-442**  
WEITLANER  
Blunt  
130 mm

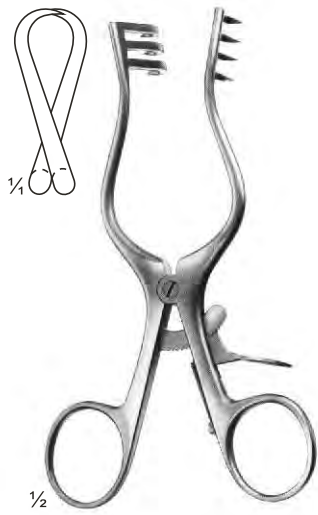

**08-443**  
WEITLANER  
Sharp  
130 mm

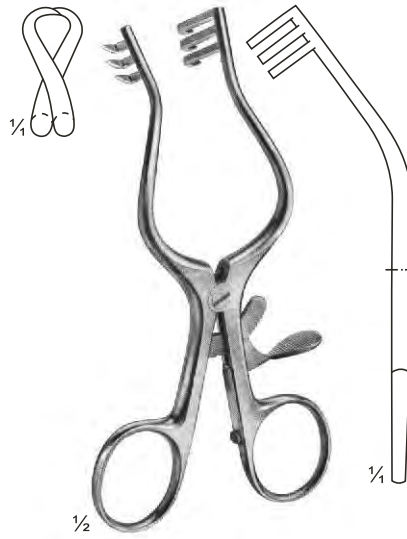

**08-444**  
WULLSTEIN  
Sharp  
130 mm

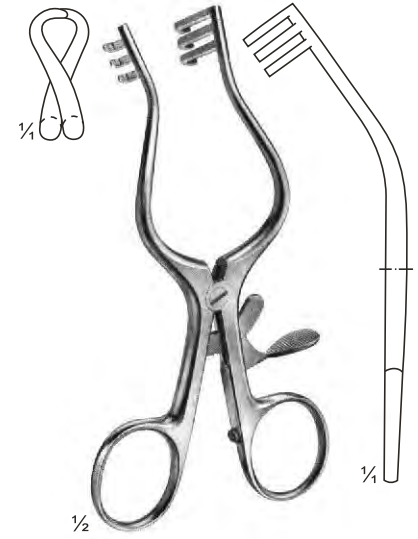

**08-445**  
WULLSTEIN  
Blunt  
130 mm



**08-446**  
WEITLANER  
Sharp  
165 mm

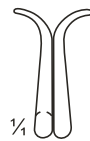

**08-447**  
PLESTER  
Blunt  
110 mm



**08-448**  
PERKINS  
130 mm



**08-449**  
ADSON-BABY  
Blunt  
140 mm

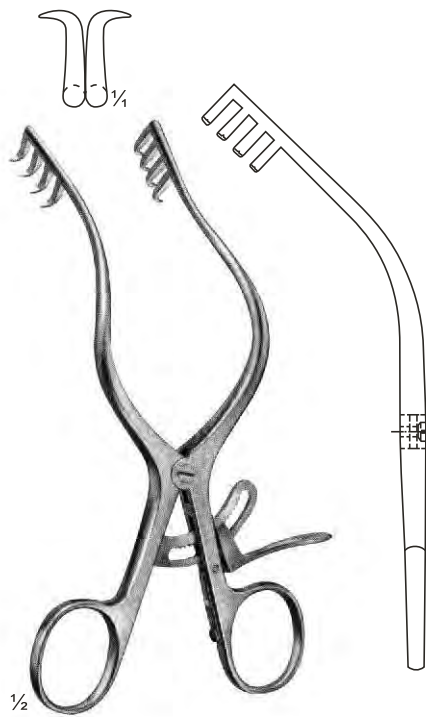

**08-450**  
MOLLISON  
Sharp  
155 mm



**08-451**  
MAYO-ADAMS  
165 mm

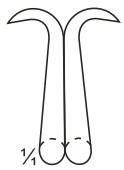

**08-452**  
ANDERSON-ADSON  
Sharp  
190 mm



**08-453**  
NORFOLK and  
NORWICH  
Blunt  
220 mm



**08-454**  
ADSON  
Sharp  
265 mm

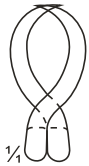

Sharp



Semi-Sharp

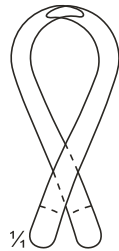

Semi-Sharp

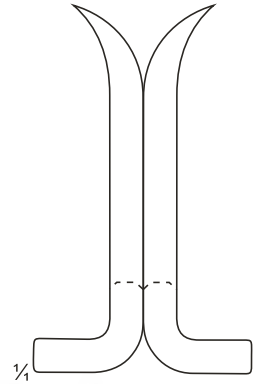

1/4

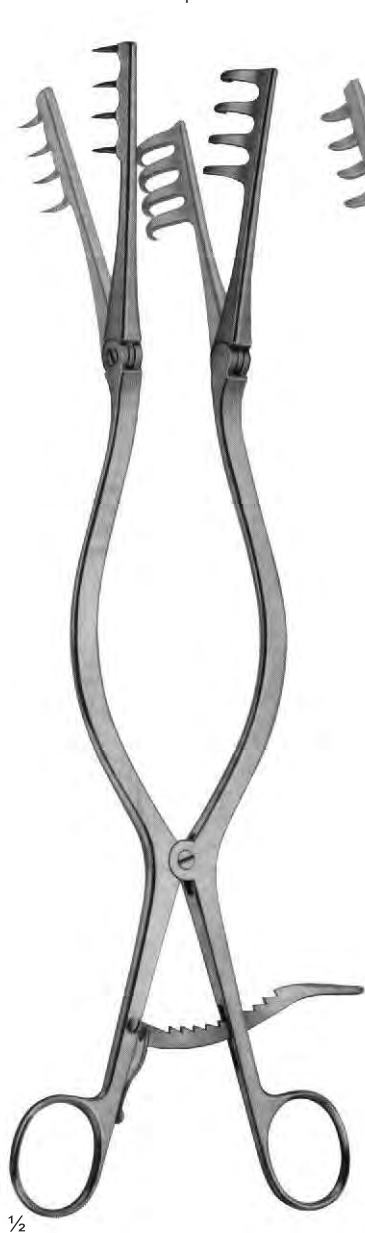

1/2

**08-455 - 456**  
BECKMANN-ADSON  
Sharp  
310 mm



**08-456**  
BECKMANN-ADSON  
Semi-Sharp  
310 mm



1/2

**08-457**  
ADSON  
Semi-Sharp  
320 mm



1/2

**08-458**  
BECKMANN-EATON  
Sharp  
320 mm



1/2

**08-459**  
**JOLL ( FRIEDMAN )**  
 Thyroid- and Vaginal Retractor  
 155 mm

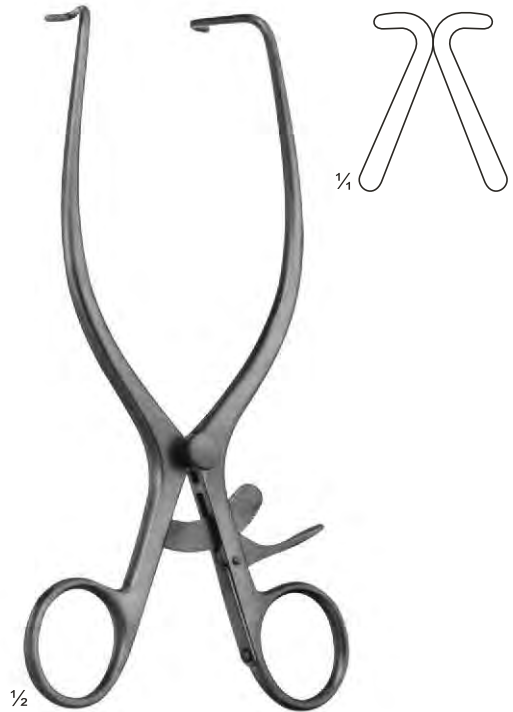

1/2

**08-460**  
**JACKSON BURROWS**  
 Retractor, blunt  
 185 mm

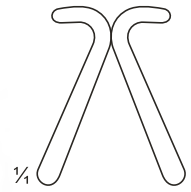

1/4

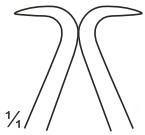

1/4



1/2

**08-461**  
**GELPI**  
 Vaginal Retractor  
 135 mm

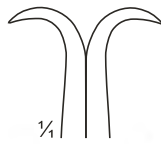

1/4



1/2

**08-462**  
**GELPI**  
 Skin- and Vaginal Retractor  
 175 mm

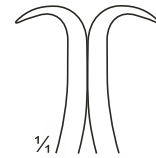

1/4



1/2

**08-463**  
**DE BAKEY**  
 Femur Retractor  
 145 mm

# Self Retaining Retractors for Laminectomy and other Operations

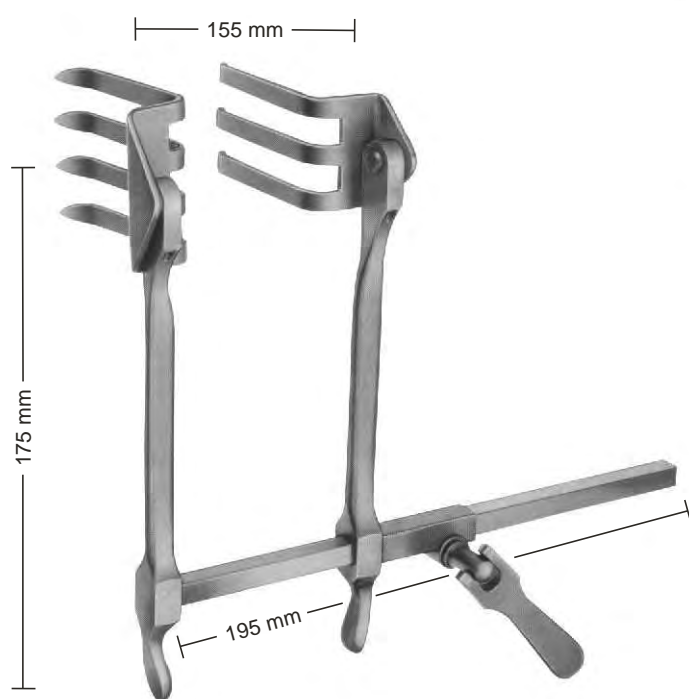

**08-464 - 468**  
**SCOVILLE-RICHTER**  
 Retractor with 1 pair  
 blades reversible type.  
 The Retractor bar and  
 shanks may be easily  
 rotated 180° when  
 blades are in situ.



**08-465**  
 62 x 52 mm    62 x 37 mm  
 PR= Pair



**08-466**  
 47 x 51 mm



**08-467**  
 30 x 40 mm



**08-468**  
 37 x 62 mm



**08-469**  
CLOWARD modif.  
Spreader Only



16 mm  
**08-470**

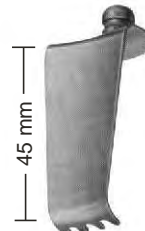

16 mm  
**08-471**



16 mm  
**08-475**



16 mm  
**08-476**



16 mm  
**08-472**

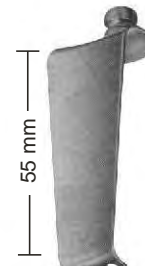

16 mm  
**08-473**

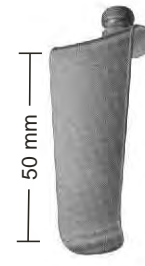

16 mm  
**08-477**

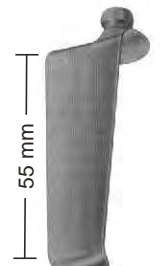

16 mm  
**08-478**

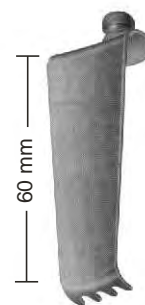

16 mm  
**08-474**



16 mm  
**08-479**

08-470 blade  
08-471 blade  
08-472 blade  
08-473 blade  
08-474 blade

08-475 blade  
08-476 blade  
08-477 blade  
08-478 blade  
08-479 blade

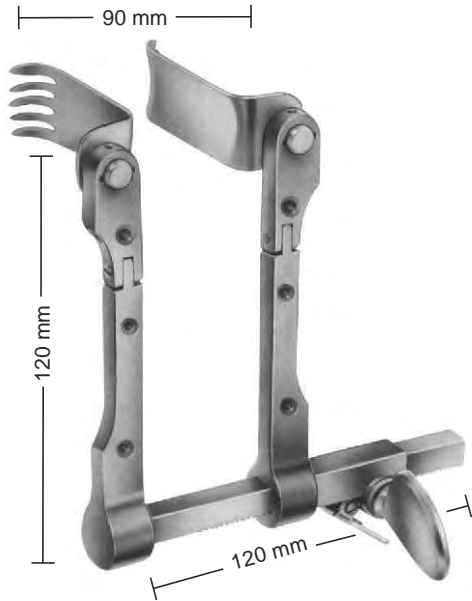

**08-480**  
CASPAR  
Retractor, adjustable,  
consisting of: 5 medial  
blades, 5 Lateral blades.

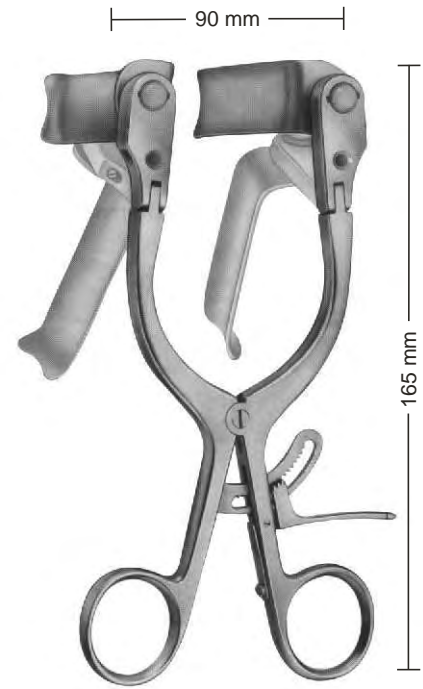

**08-480 A**  
CASPAR  
Counter retractor, adjustable,  
consisting of: 5 blades.



**08-481** 40 x 23 mm  
**08-482** 45 x 23 mm  
**08-483** 50 x 23 mm  
**08-484** 55 x 23 mm  
**08-485** 60 x 23 mm  
Medial blades

**08-486** 40 x 23 mm  
**08-487** 45 x 23 mm  
**08-488** 50 x 23 mm  
**08-489** 55 x 23 mm  
**08-490** 60 x 23 mm  
Lateral blades

**08-491** 45 x 23 mm  
**08-492** 50 x 23 mm  
**08-493** 55 x 23 mm  
**08-494** 60 x 23 mm  
**08-495** 65 x 23 mm  
Blunt blades

**08-496** 50 x 25 mm  
**08-497** 60 x 25 mm  
Blunt blades,  
for harvesting of the  
fusion graft from the  
iliac crest

**08-498** 40 x 25 mm  
**08-499** 45 x 25 mm  
**08-500** 50 x 25 mm  
**08-501** 55 x 25 mm  
**08-502** 60 x 25 mm  
Medial Titan blades  
semi transparent to x-ray

**08-503** 40 x 25 mm  
**08-504** 45 x 25 mm  
**08-505** 50 x 25 mm  
**08-506** 55 x 25 mm  
**08-507** 60 x 25 mm  
Lateral Titan blades  
semi transparent to x-ray

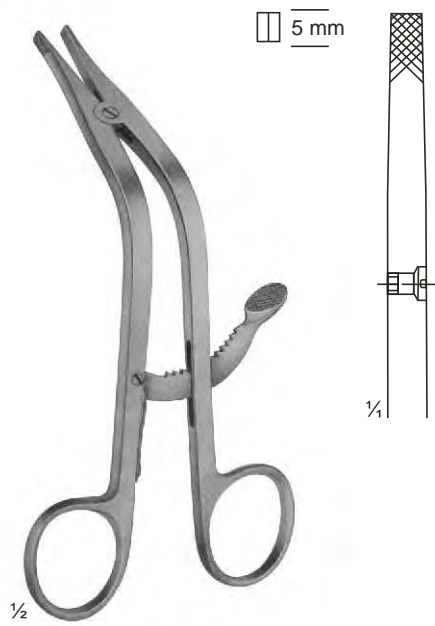

5 mm

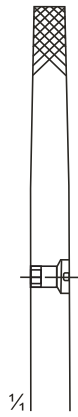

**08-508**  
CLOWARD  
155 mm



4,5 mm



**08-509**  
CLOWARD  
135 mm



6 mm

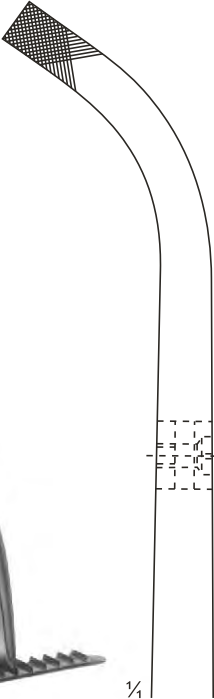

**08-510**  
INGE  
170 mm

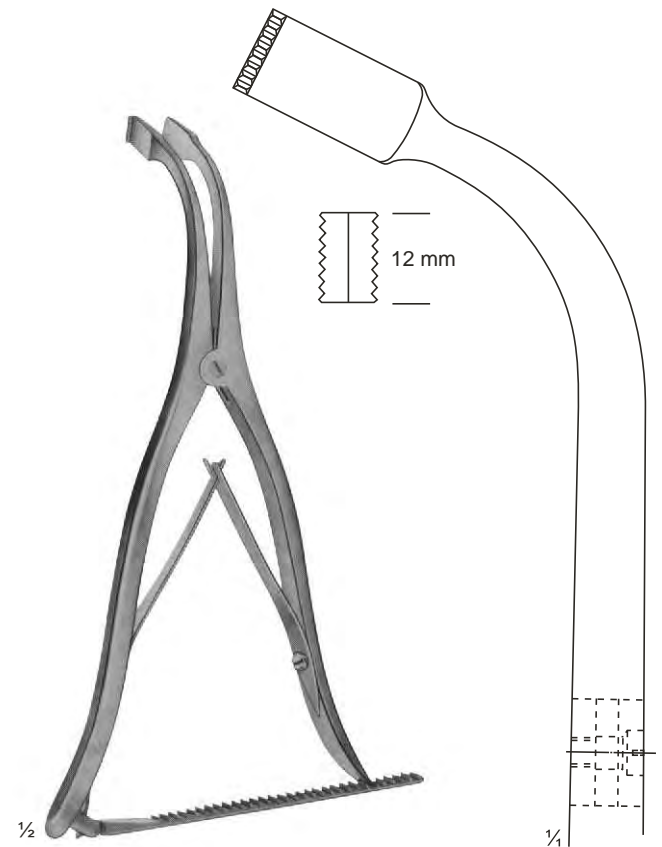

12 mm



**08-511**  
INGE  
275 mm



**08-512**  
BABY-COLLIN  
with 2 pair of blades

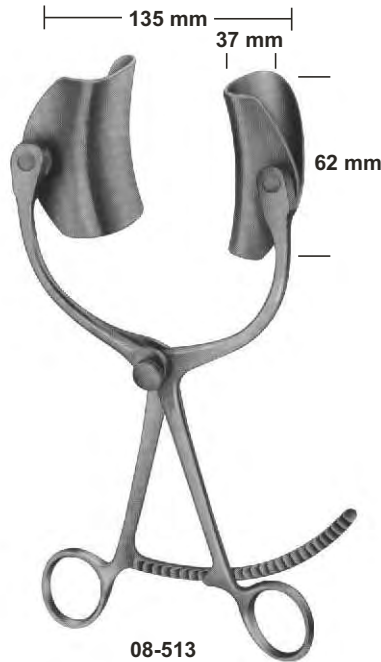

**08-513**  
COLLIN  
complete

08-817 135 mm  
08-818 160 mm



08-516  
08-515  
08-514  
08-514  
08-514  
08-514

Spreader only  
Lateral blade  
Canter blade

37x98mm  
37x80mm  
54x67mm  
37x62mm  
54x55mm

**08-514 - 518**  
COLLIN  
complete

210 mm



**08-519 - 520**  
RICARD  
complete

Spreader only  
Lateral blade  
Canter blade

08-519  
58x80mm  
54x70mm

08-520  
72x84mm  
72x90mm

275 mm



**08-521 - 523**  
HOLZBACH  
Complete

08-521 Spreader only  
08-522 Lateral blade  
08-523 Canter blade

59x80mm  
74x82mm

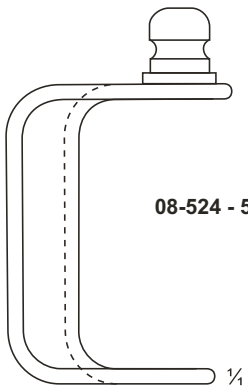

**08-524 - 526**

Lateral blades only  
**08-524** 37x62 mm  
**08-525** 37x80 mm  
**08-526** 37x98 mm

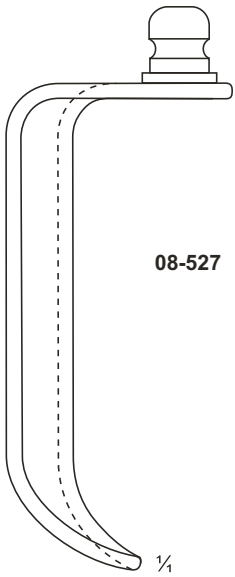

**08-527**

**08-527** 61x80 mm

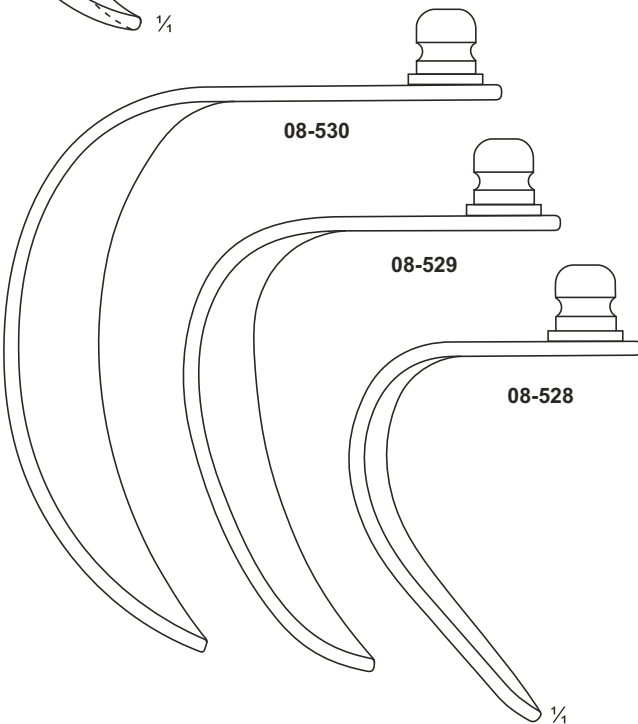

**08-530**

**08-529**

**08-528**

**08-528** 48x59 mm  
**08-529** 58x80 mm  
**08-530** 72x84 mm

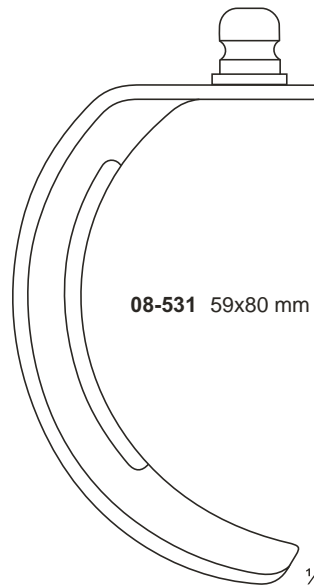

**08-531** 59x80 mm



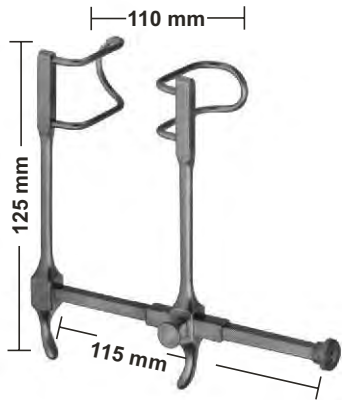

**08-532**  
GOSSET  
Blades: 38 mm deep

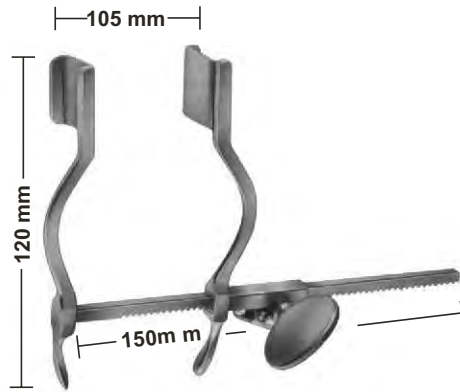

**08-533**  
HERTZLER  
Blades 20 X 25 mm

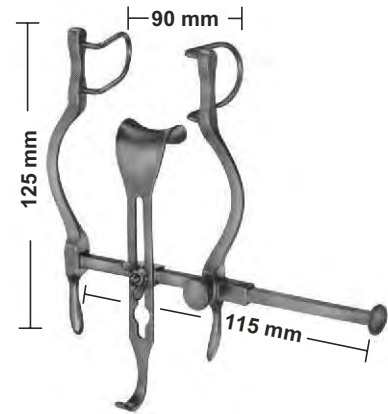

**08-534**  
BALFOUR-BABY  
Lateral blades 27 mm deep  
Center blade 21x24 mm

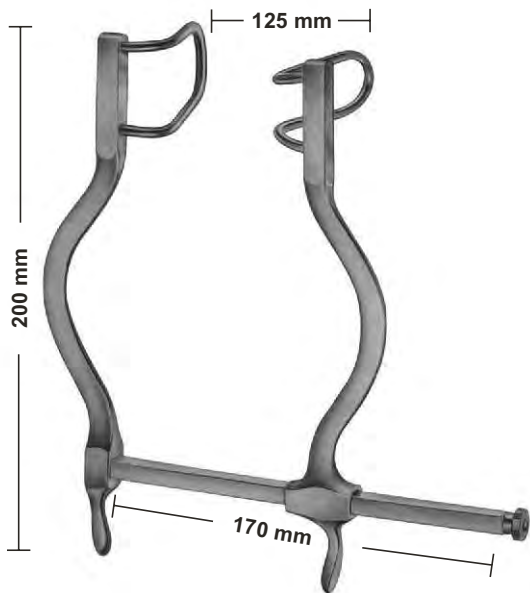

**08-535**  
GOSSET  
Blades: 55 mm deep

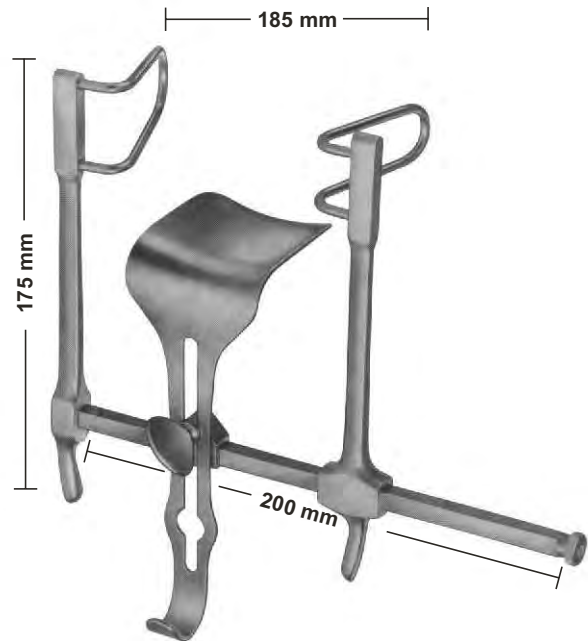

**08-536**  
GOSSET  
Lateral blades 58 mm deep  
Center blade 59 x 57 mm

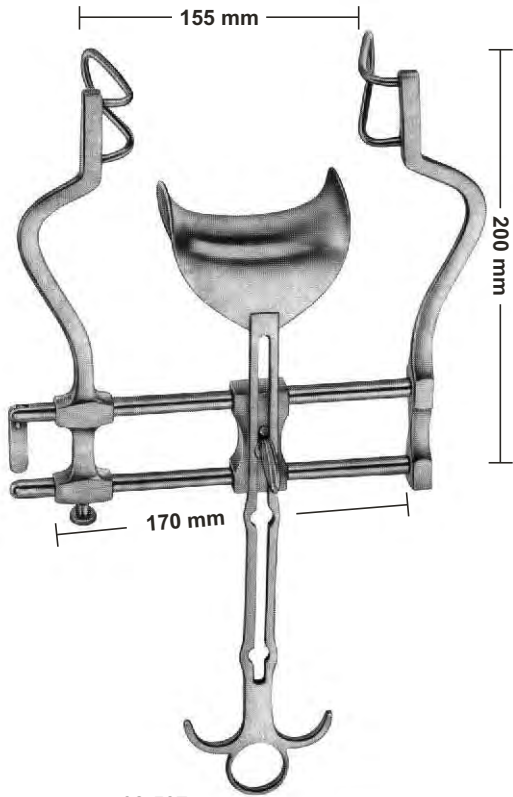

**08-537**  
BALFOUR  
Lateral blades 60 mm deep  
Center blade 47 x 80 mm

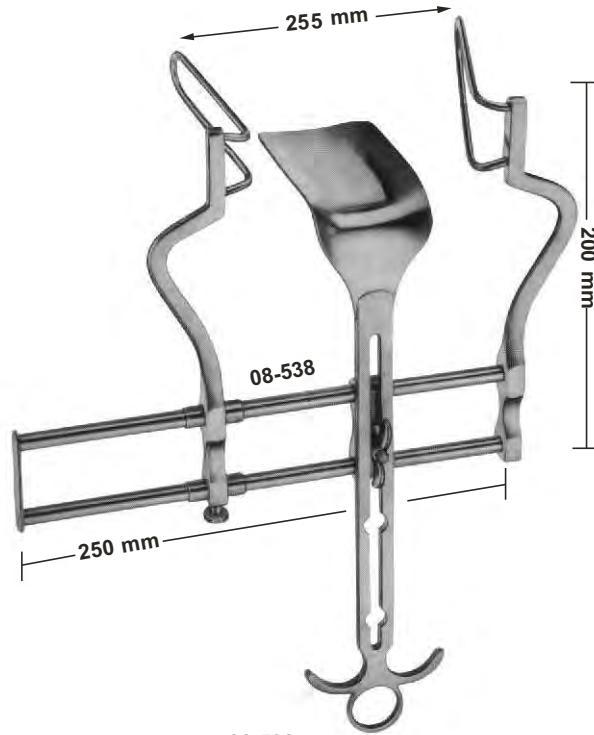

**08-538**  
BALFOUR  
Lateral blades 105 mm deep  
Center blade 107x 59 mm

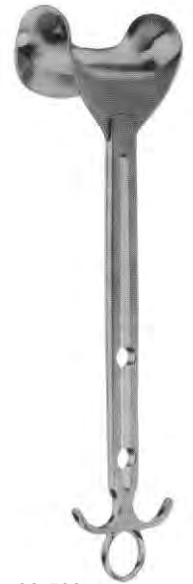

**08-539**  
Center blade only  
54x80 mm

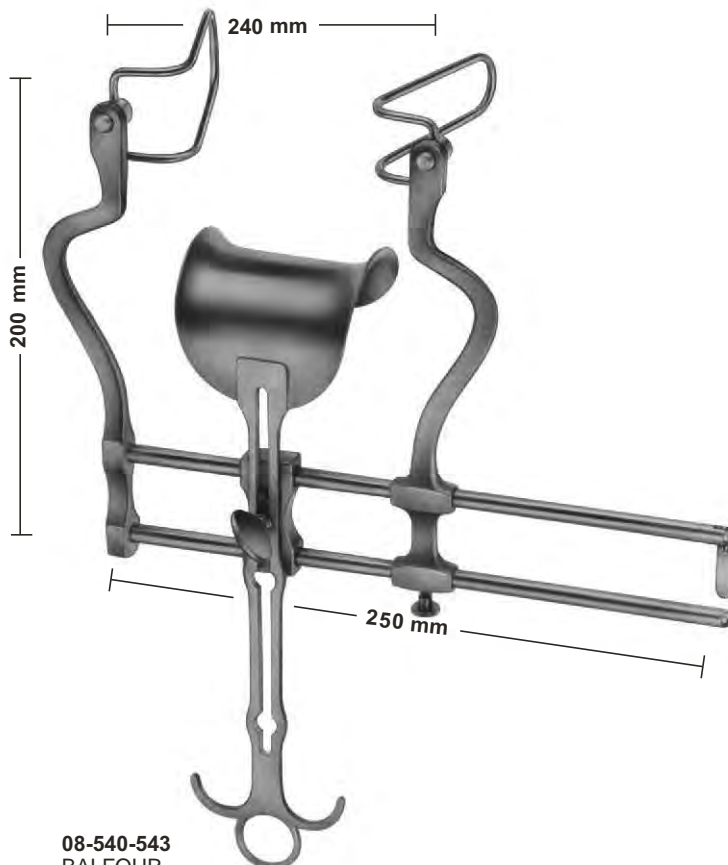

**08-540-543**  
BALFOUR  
Spreader only **08-540**    **08-541**    **08-542**    **08-543**  
Lateral blades 50 mm    60 mm    75 mm    90 mm  
Center blade 47 x 80 mm    62x76 mm    80x80 mm    80x80 mm



Lateral blades  
**08-544** 50 mm deep  
**08-545** 60 mm deep  
**08-546** 75 mm deep  
**08-547** 90 mm deep  
Sales Unit of blades: PR = pair

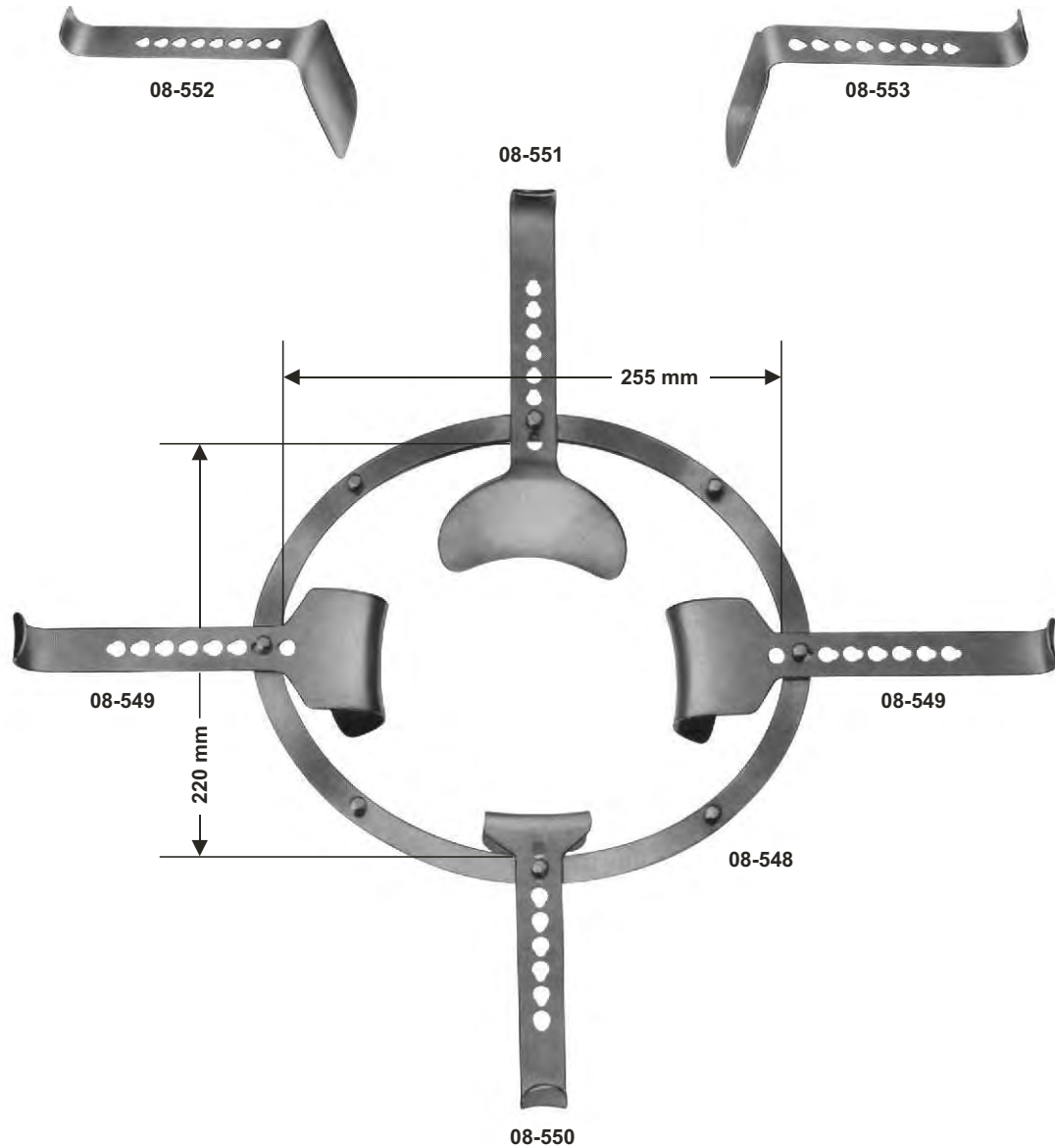

**08-548 - 08-553**

SEMM  
consisting of:

- 08-548** 1 frame 225 x 220 mm
- 08-549** 2 blades 46 x 64 mm
- 08-550** 1 blade 53 x 54 mm  
(for bladder)
- 08-551** 1 blade 82 x 97 mm  
(for intestine)
- 08-552** 1 blade 98 x 51 mm  
(for intestine)
- 08-553** 1 blade, narrow  
107 x 36 mm

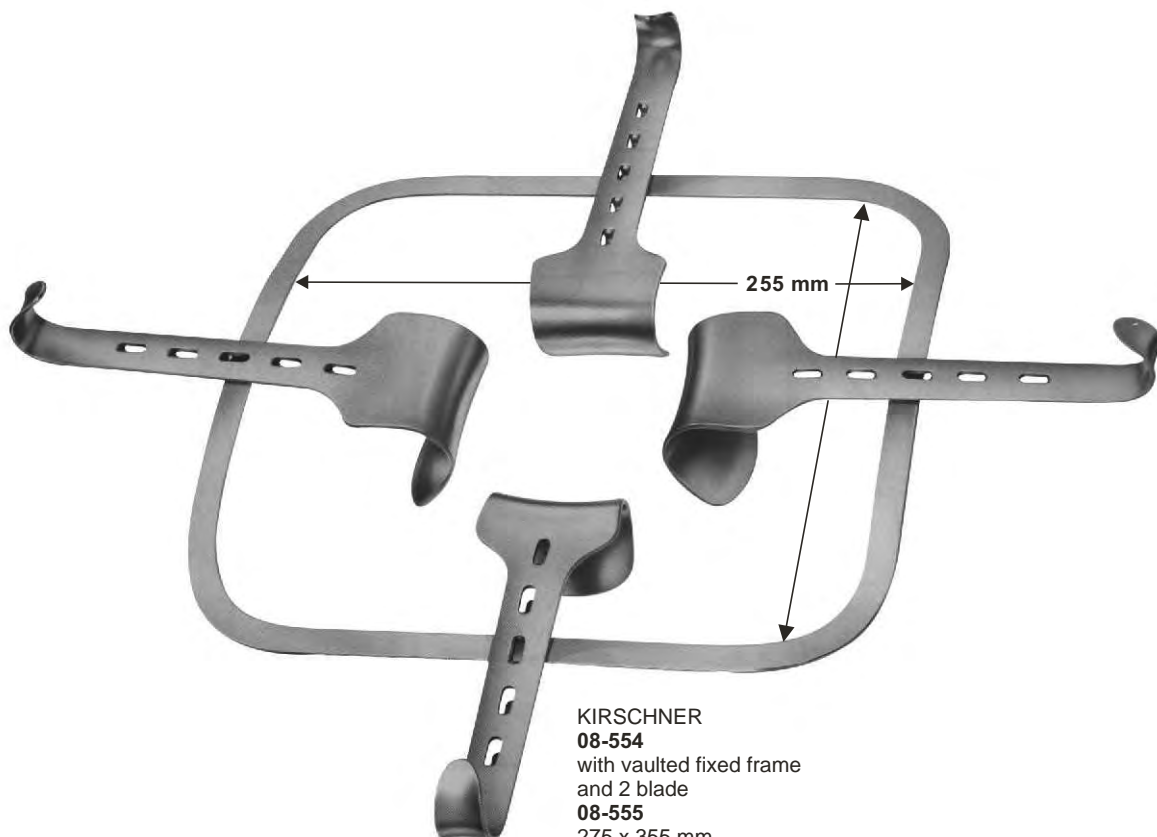

**KIRSCHNER**  
**08-554**  
 with vaulted fixed frame  
 and 2 blade  
**08-555**  
 275 x 355 mm  
 Frame only, over-sized  
**08-556**  
 295 x 275 mm  
 Frame only



**08-557**  
**KIRSCHNER**  
 64 x 80 mm



**08-558**  
**KIRSCHNER-BALFOUR**  
 80x 82 mm



**08-559 - 561**  
**KIRSCHNER**  
**08-559** 90x 69mm  
**08-560** 92x 95mm  
**08-561** 78x 58mm



**08-562 - 564**  
**KIRSCHNER**  
**08-562** 108x42mm  
**08-563** 91x 55mm  
**08-564** 121x 55mm

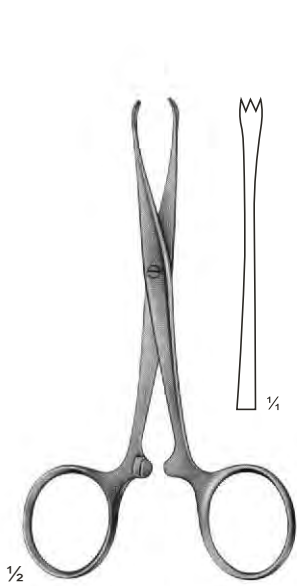

**09-101**  
**CHAPUT**  
 2 X 3 teeth, sharp  
 125 mm,

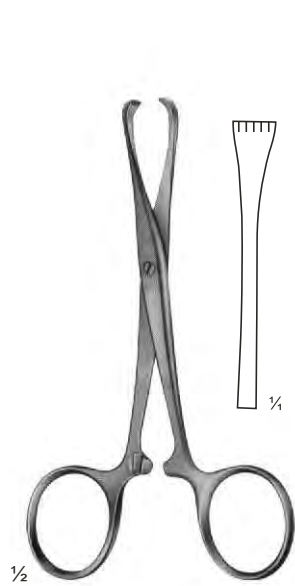

**09-102**  
**TUFFIER**  
 5 X 6 teeth, sharp  
 125 mm,



**09-103**  
**BOYS-ALLIS**  
 5 X 6 teeth, sharp  
 155 mm,

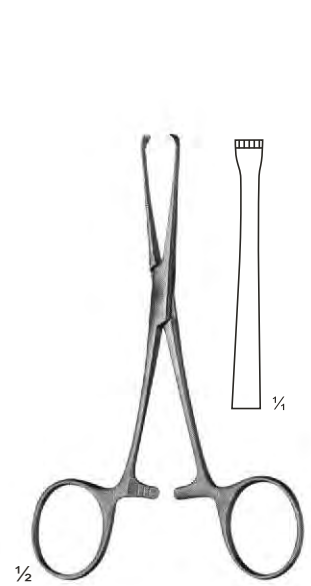

**09-104**  
**ALLIS**  
 4 X 5 teeth  
 155 mm,

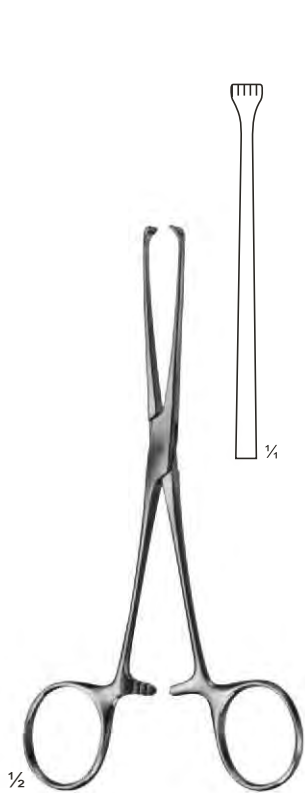

**09-105**  
**ALLIS**  
 155 mm,  
 4 X 5 teeth

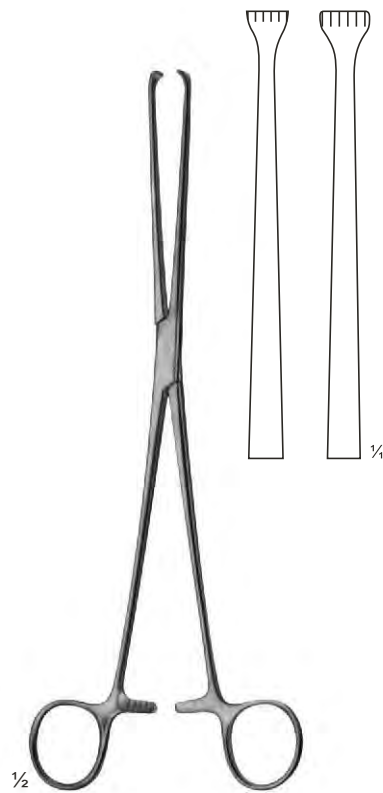

**09-106**  
**ALLIS**  
 190 mm,  
**09-107**  
 255 mm,  
 5 X 6 teeth

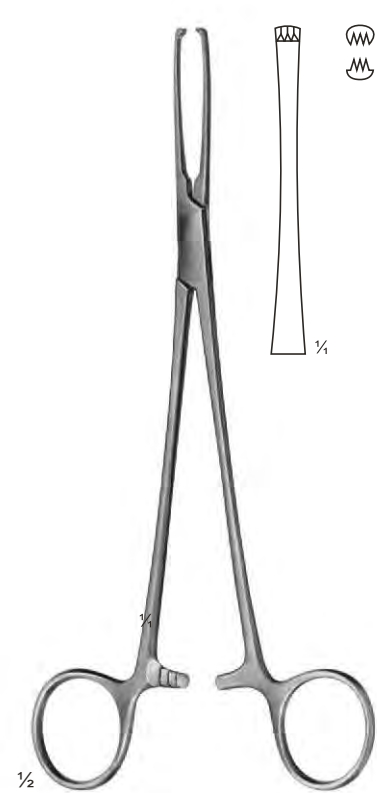

**09-108**  
**JUDD-ALLIS**  
 3 X 4 teeth  
 195 mm,

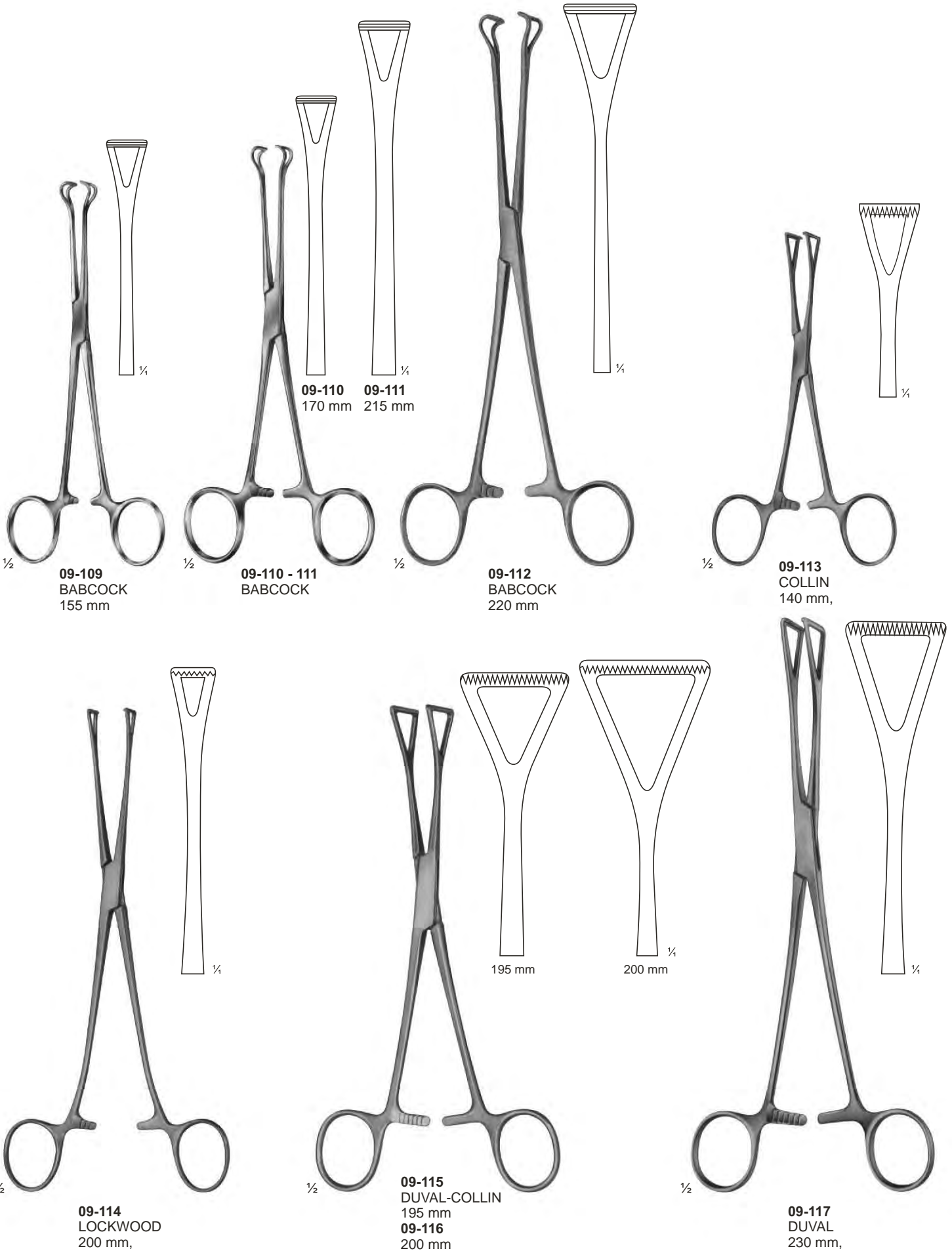

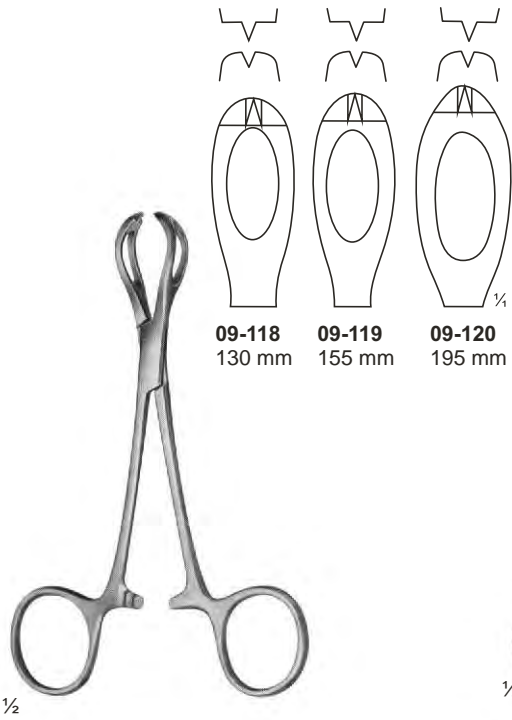

**09-118-120**  
LANE

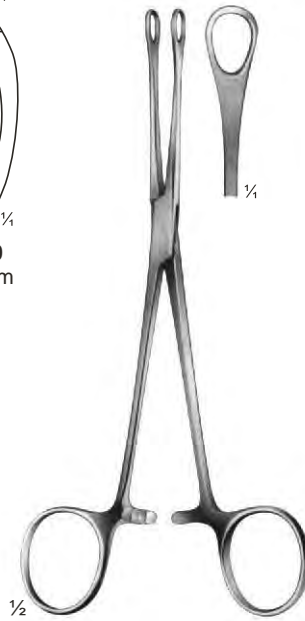

**09-121**  
WILLIAMS  
160 mm



**09-122**  
DENIS  
BROWNE  
190 mm



**09-123**  
DUVAL  
140 mm



**09-124**  
WANGENSTEEN  
150 mm  
**09-125**  
230 mm



**09-126**  
WANGENSTEEN  
150 mm  
**09-127**  
230 mm

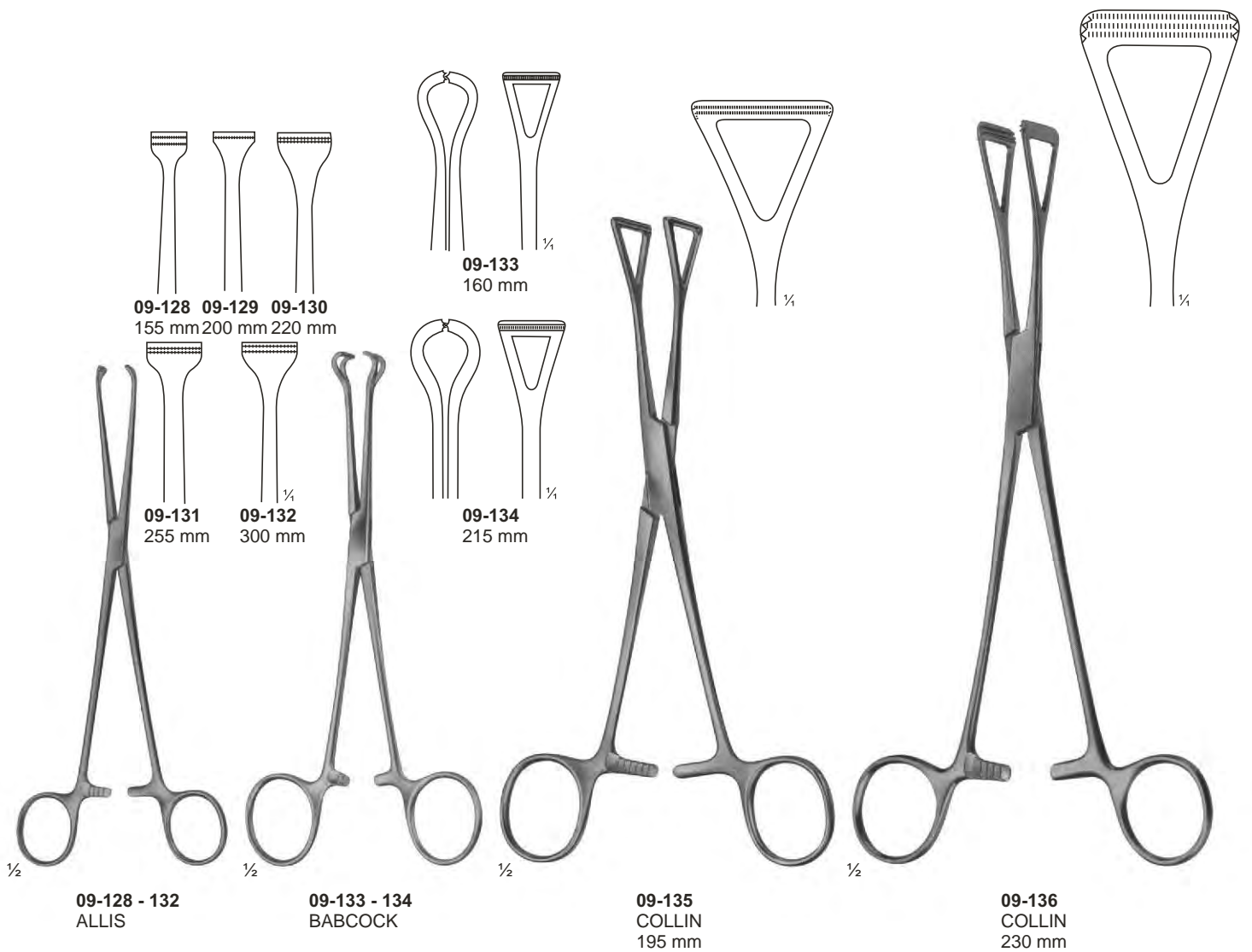

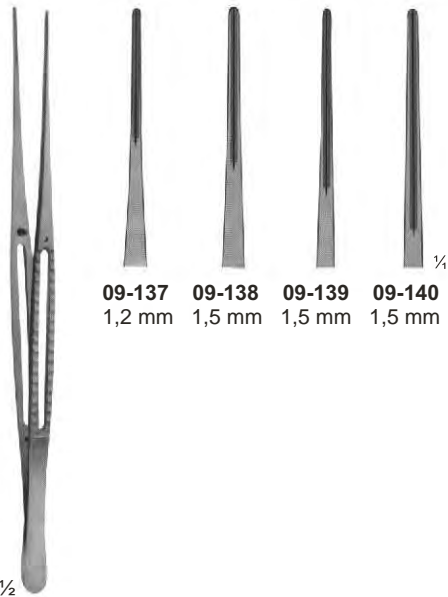

**09-137** 1,2 mm  
**09-138** 1,5 mm  
**09-139** 1,5 mm  
**09-140** 1,5 mm

**09-137** 150 mm  
**09-138** 200 mm  
**09-139** 240 mm  
**09-140** 300 mm

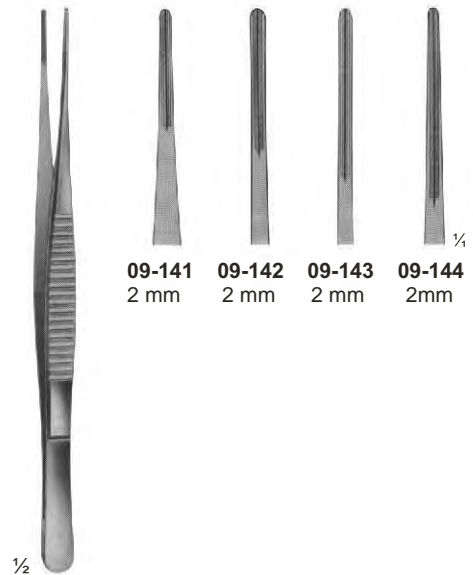

**09-141** 2 mm  
**09-142** 2 mm  
**09-143** 2 mm  
**09-144** 2mm

DE BAKEY  
**09-141** 150 mm  
**09-142** 200 mm  
**09-143** 240 mm  
**09-144** 300 mm

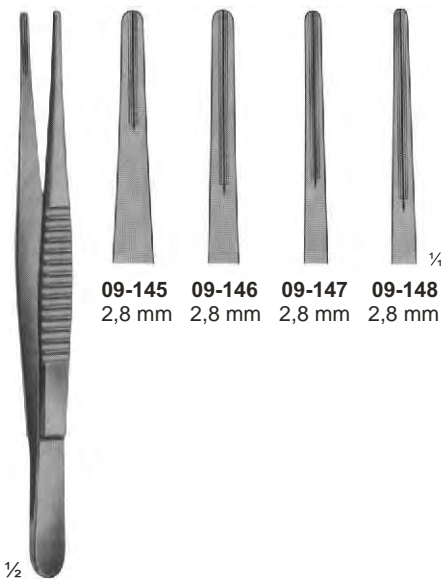

**09-145** 2,8 mm  
**09-146** 2,8 mm  
**09-147** 2,8 mm  
**09-148** 2,8 mm

DE BAKEY  
**09-145** 150 mm  
**09-146** 200 mm  
**09-147** 240 mm  
**09-148** 300 mm

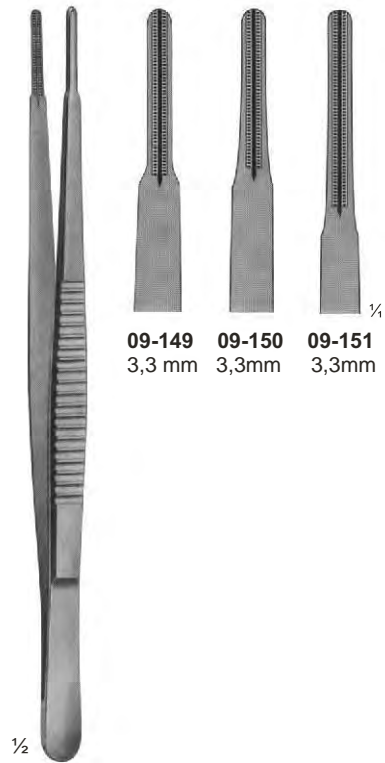

**09-149** 3,3 mm  
**09-150** 3,3mm  
**09-151** 3,3mm

DE BAKEY  
**09-149** 200 mm  
**09-150** 240 mm  
**09-151** 300 mm

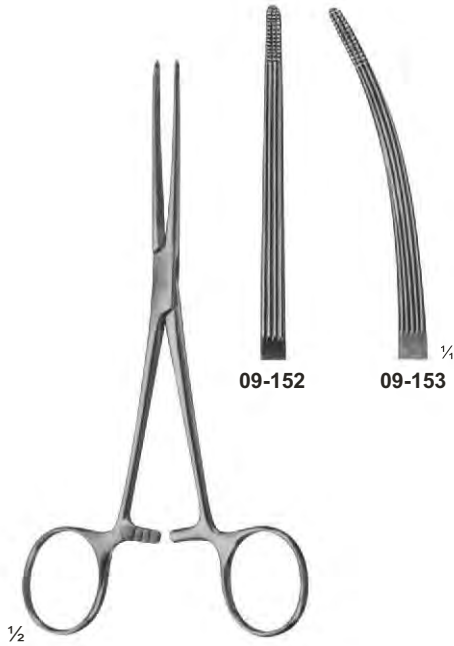

**09-152 - 153**  
BAINBRIDGE  
155 mm



**09-154**  
ALLEN  
155 mm

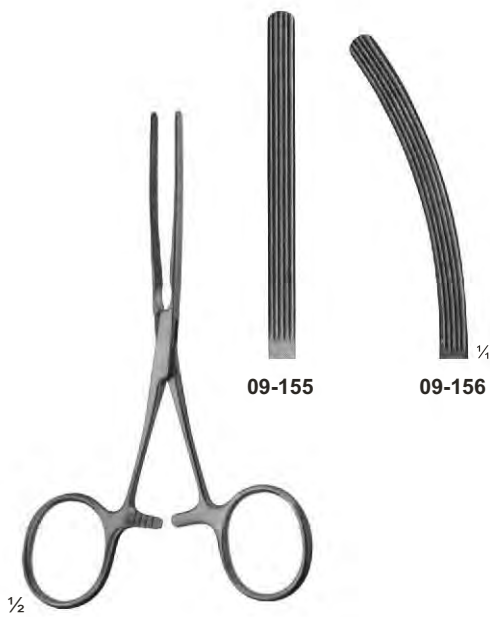

**09-155 - 156**  
BABY-KOCHER  
very elastic blades  
130 mm

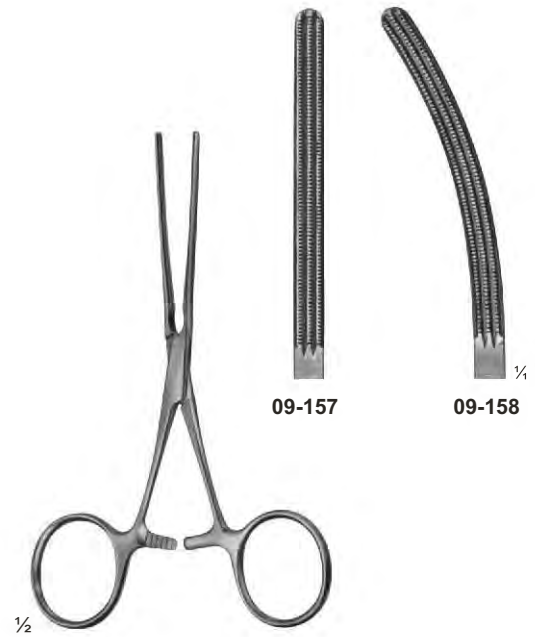

**09-157 - 158**  
BABY-KOCHER  
with elastic blades  
130 mm

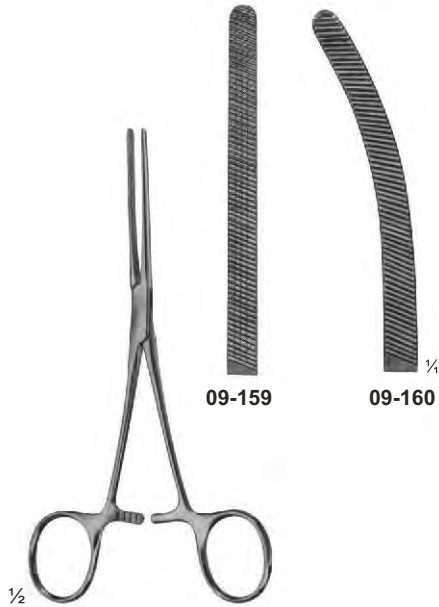

**09-159 - 160**  
DOYEN  
elastic  
165 mm

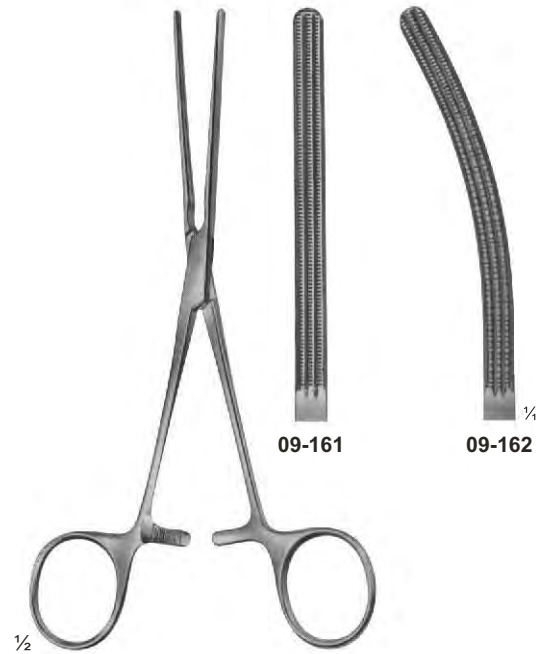

**09-161 - 162**  
DOYEN  
with elastic blades  
170 mm

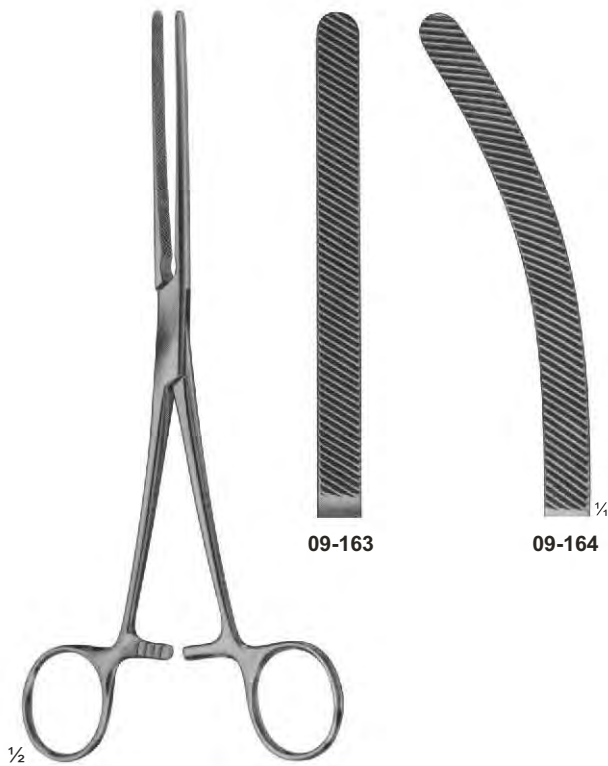

**09-163 - 164**  
HARTMANN  
with elastic blades  
200 mm



**09-165 - 166**  
HARTMANN  
with elastic blades  
200 mm

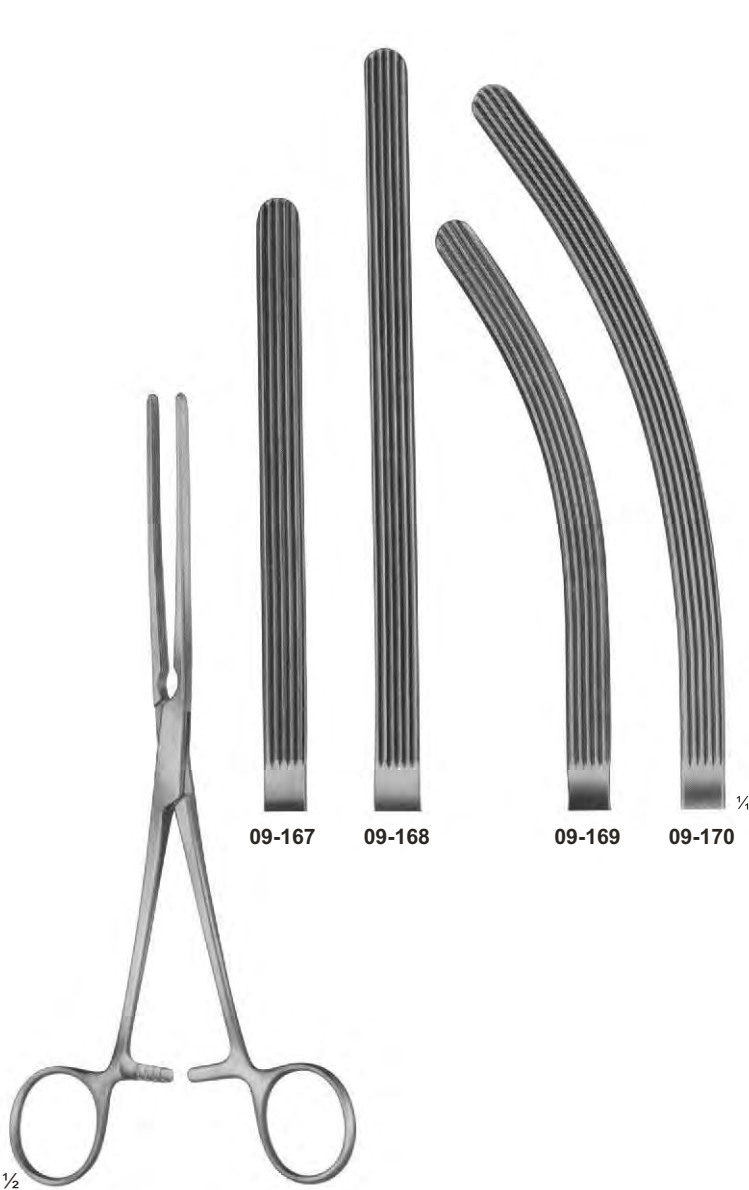

**09-167 - 170**  
KOCHER  
with elastic blades  
**09-169** 210 mm  
**09-170** 230 mm

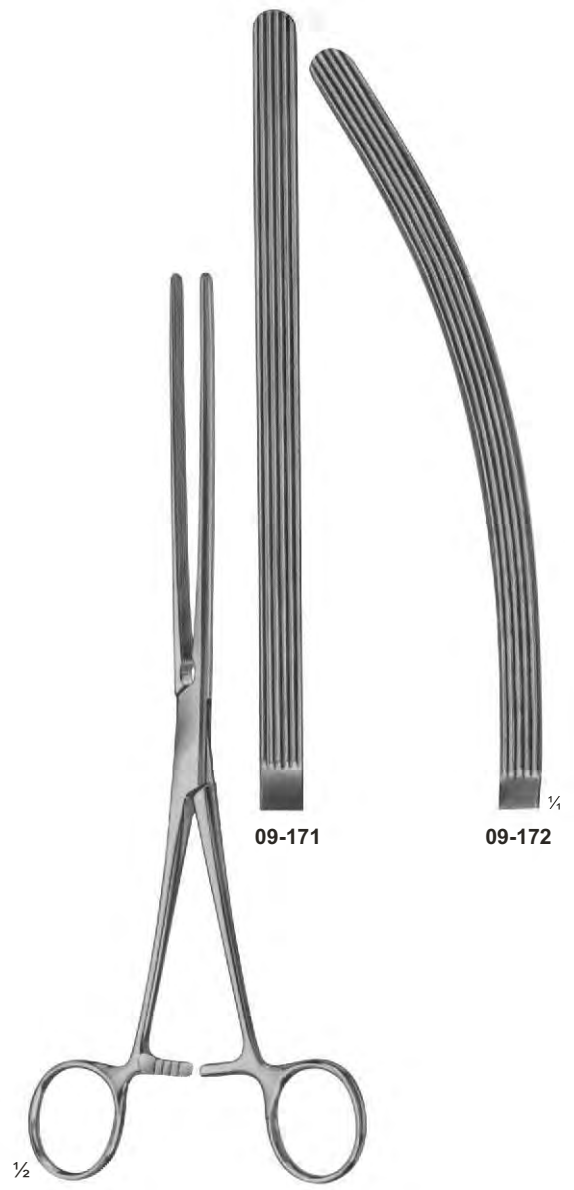

**09-171 - 172**  
DOYEN  
with elastic blades  
210 mm

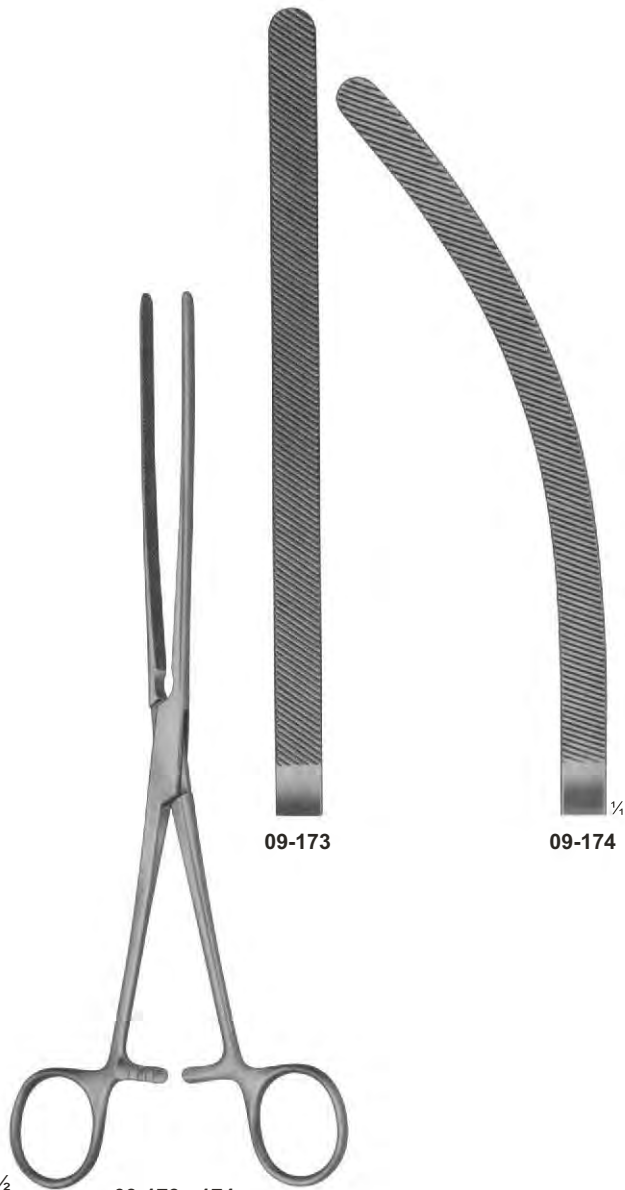

**09-173 - 174**  
DOYEN  
with elastic blades  
235 mm

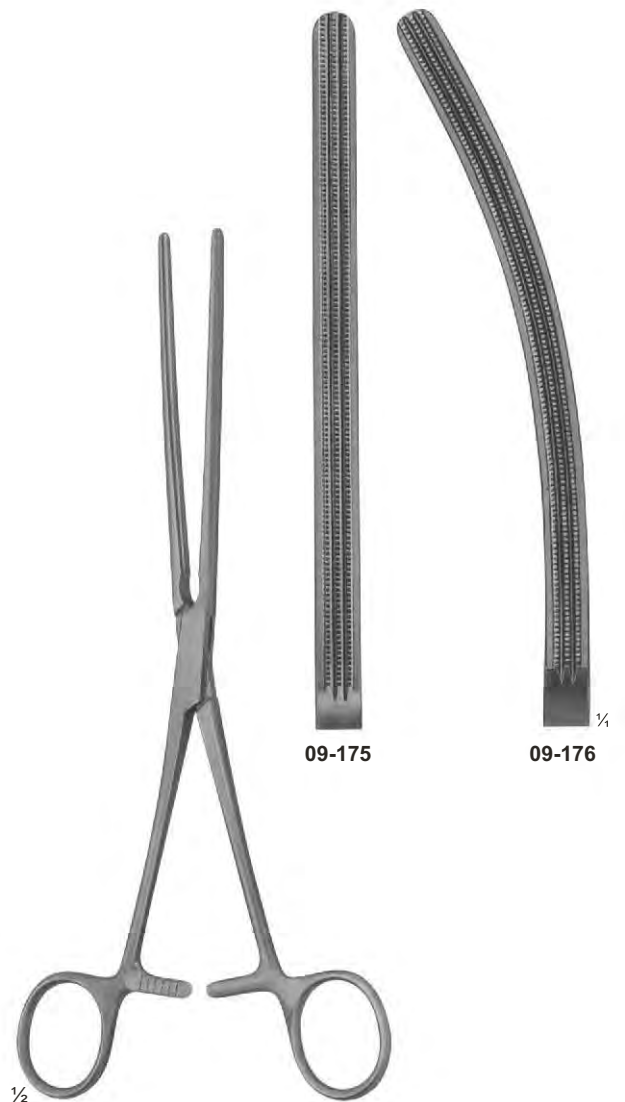

**09-175 - 176**  
DOYEN  
with elastic blades  
230 mm



1/2

**09-177 - 182**  
KOCHER  
with very elastic blades

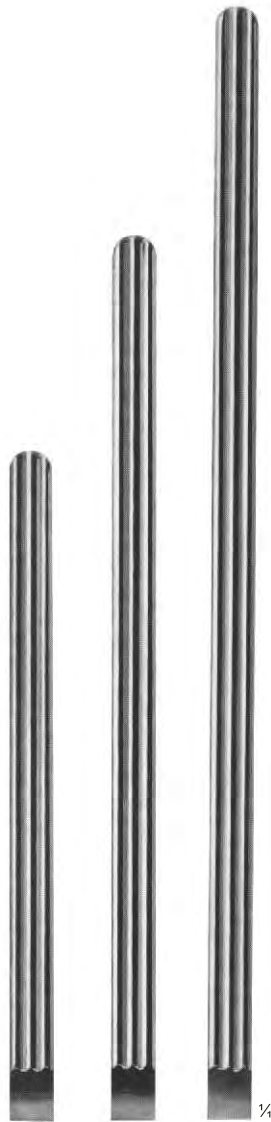

**09-177** 220 mm  
**09-178** 250 mm  
**09-179** 280 mm



**09-180** 220 mm  
**09-181** 250 mm  
**09-182** 280 mm

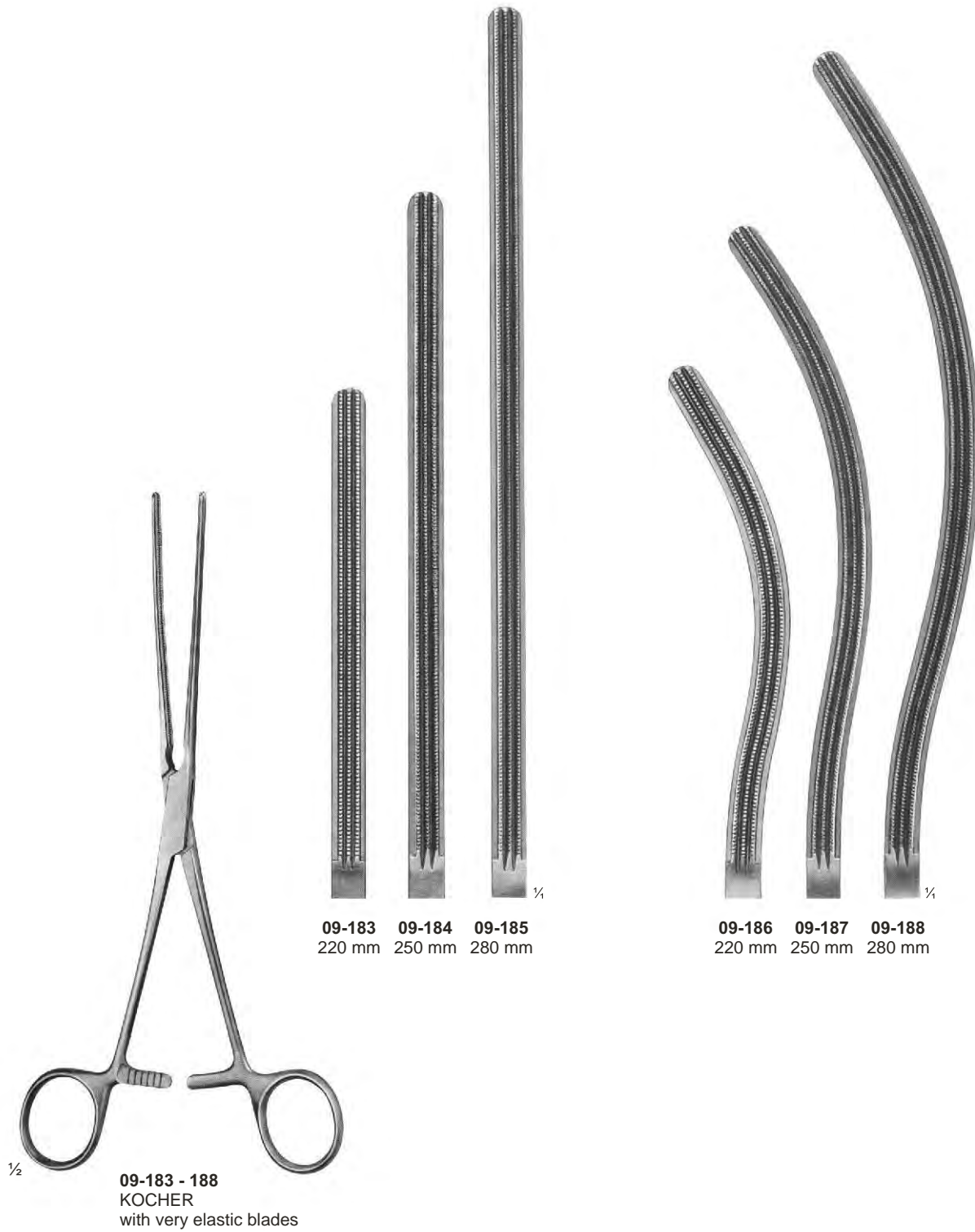

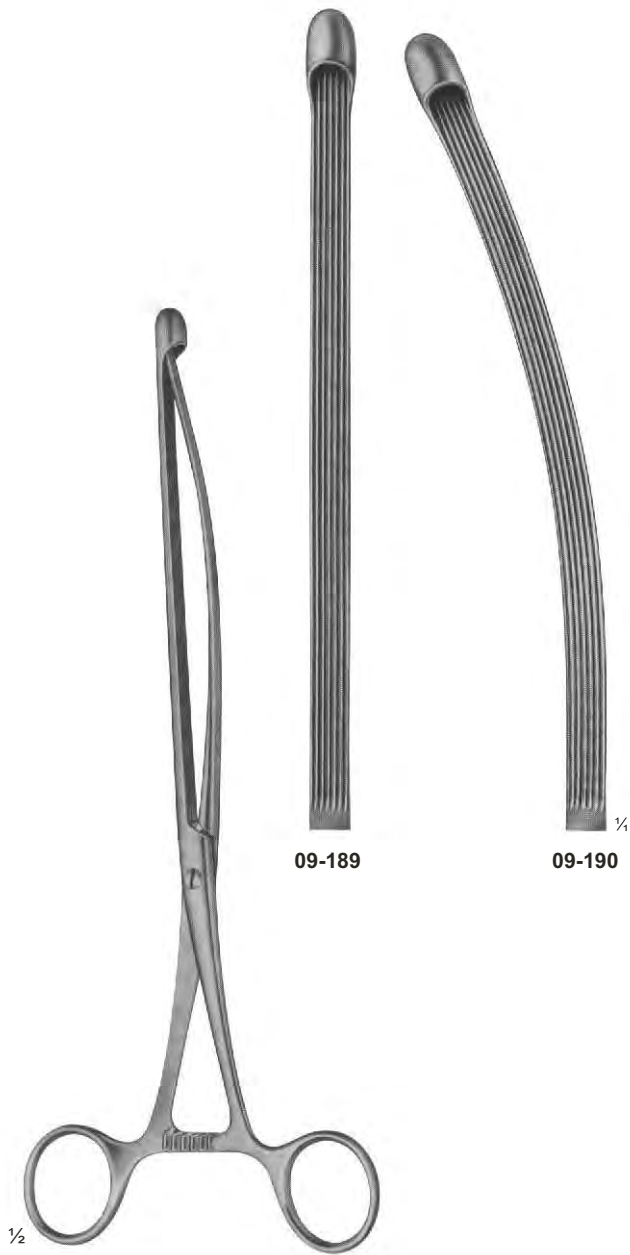

09-189

09-190

1/2

**09-189 - 190**  
NUSSBAUM  
with elastic blades  
250 mm

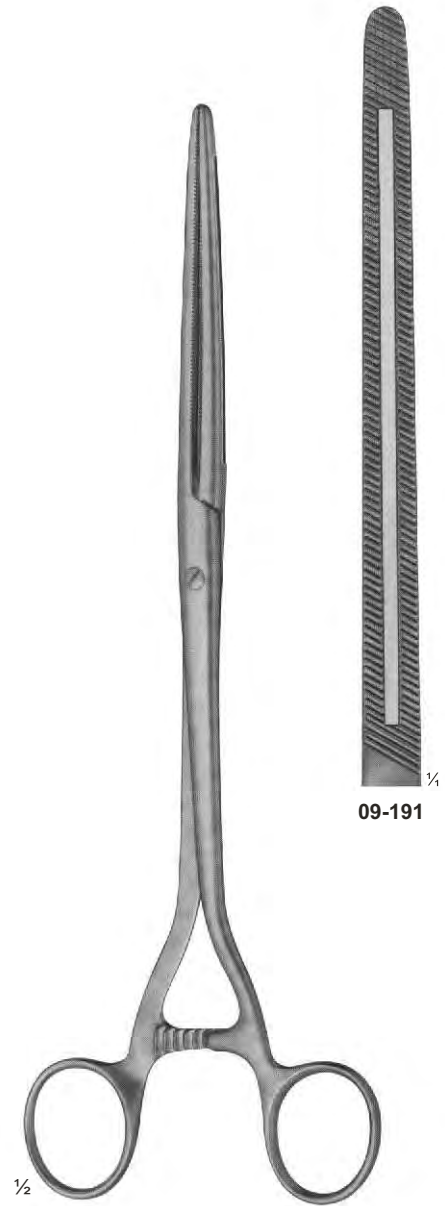

09-191

1/2

**09-191**  
MOYNIHAN  
280 mm

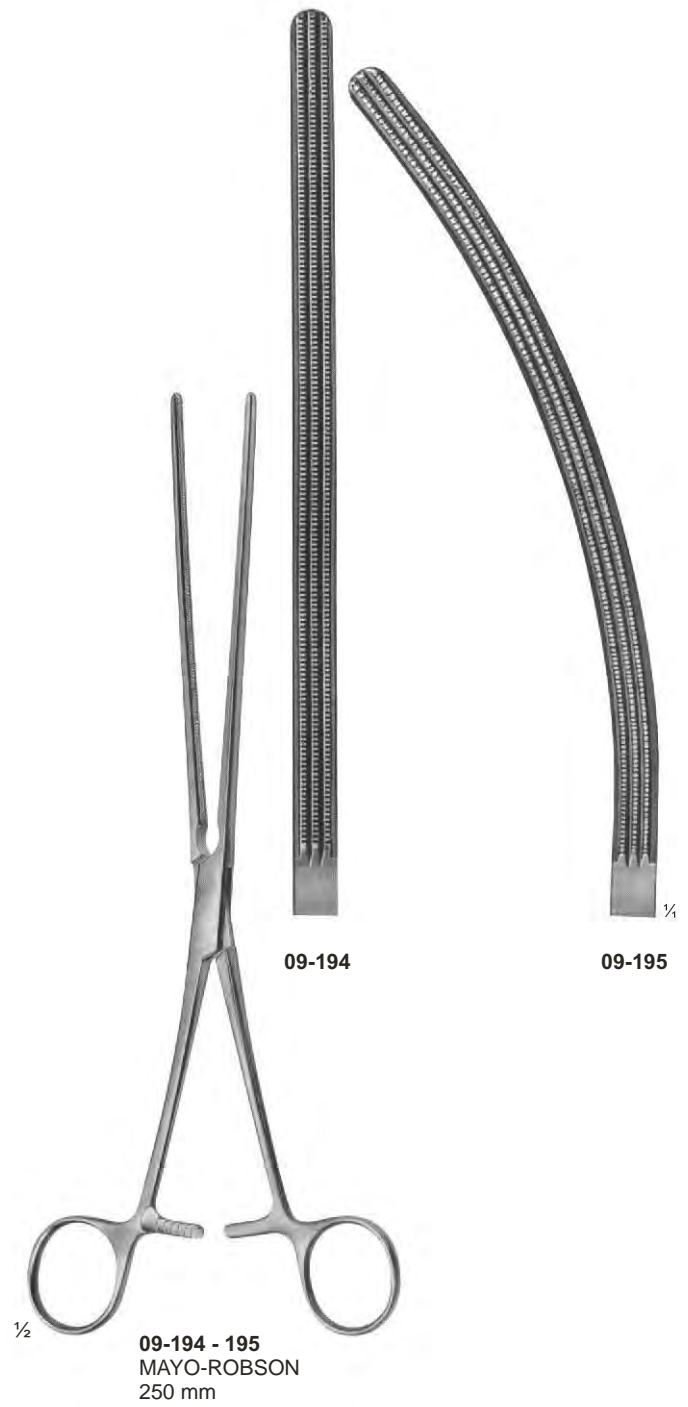
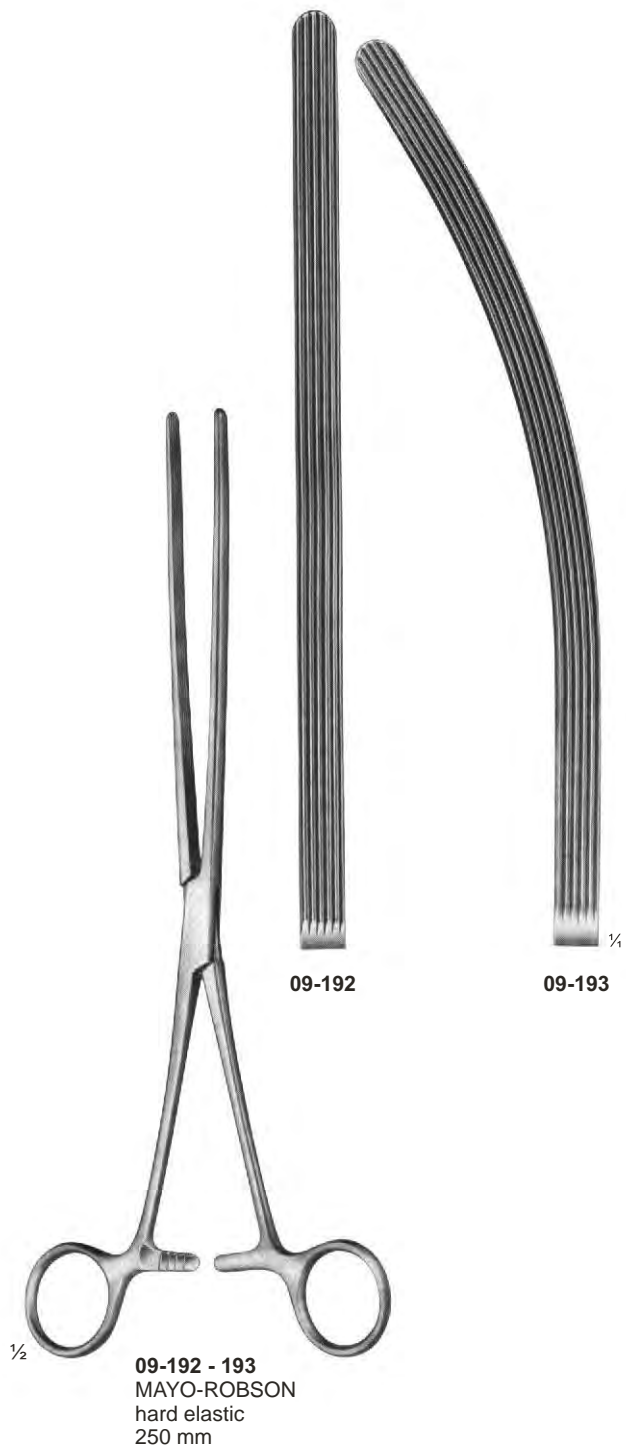



**09-196**  
LANE  
300 mm

**09-197**  
LANE  
300 mm



09-198

09-199

09-198 - 199  
SCUDDER  
330 mm



09-200  
KLEINSCHMIDT  
Spur crushers and  
Appendectomy clamps  
130 mm



**09-201**  
PAYR  
Intestinal clamp  
light pattern,  
for children  
180 mm

**09-202**  
PAYR  
200 mm

**09-203**  
PAYR  
275 mm

**09-204**  
PAYR  
Pylorus clamp  
315 mm



**09-205**  
PARKER-KERR  
anastomosis forceps  
for colon resection  
180 mm

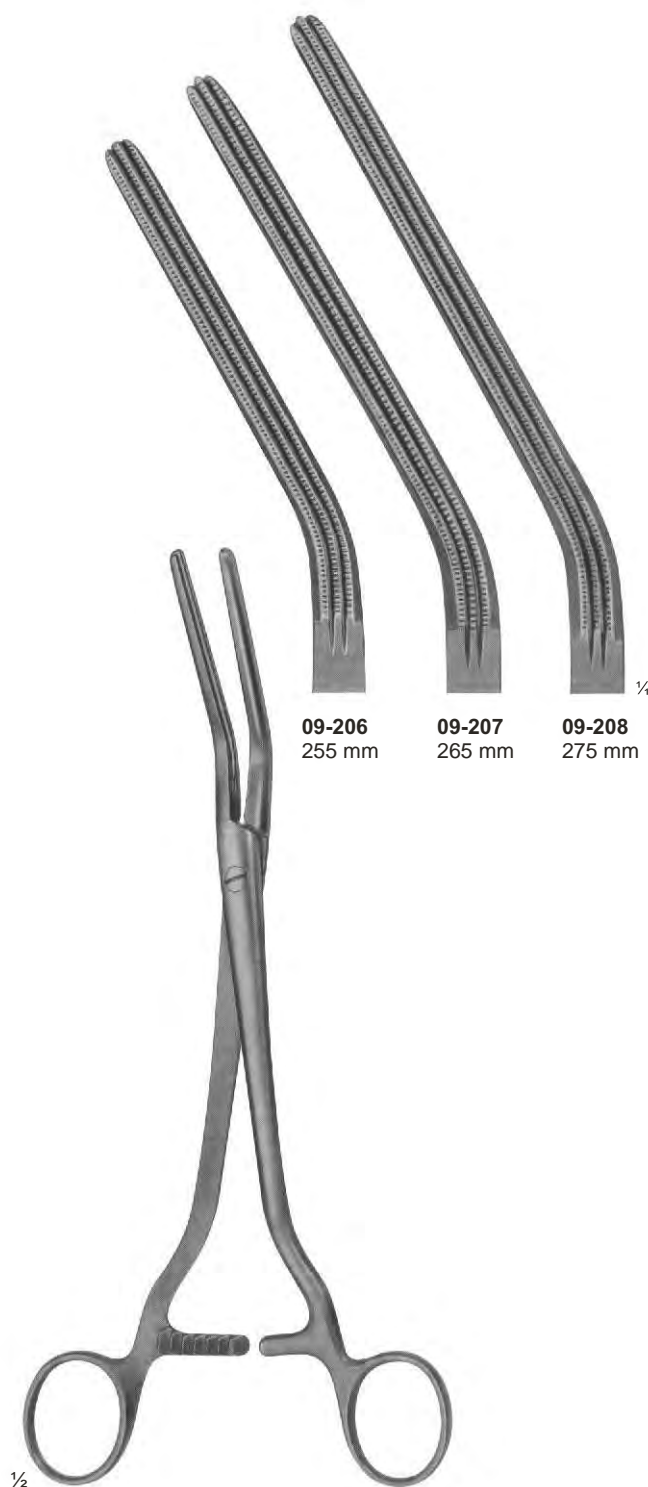

**09-206** 255 mm  
**09-207** 265 mm  
**09-208** 275 mm

**09-206 - 208**  
DICK  
pressure clamps  
180 mm



09-209 1/2

09-210 1/2

1/2

09-209  
09-210  
230 mm

1/2

09-211  
LLOYD-DAVIS  
315 mm

1/2

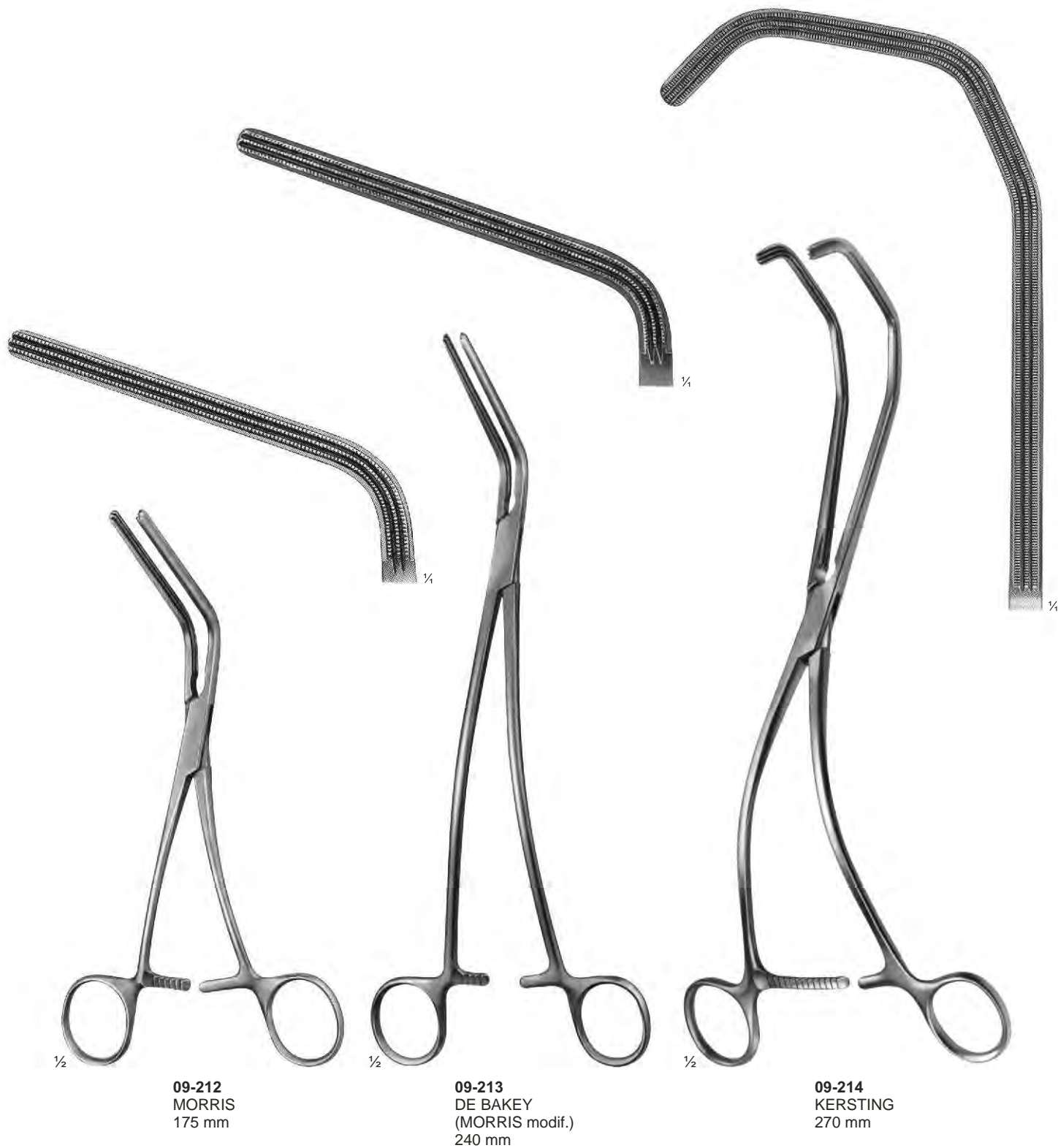

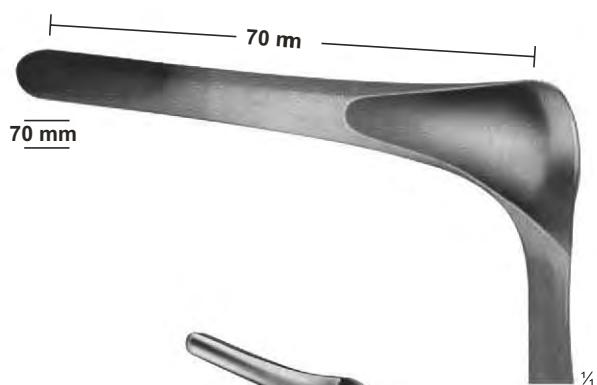

**10-101**  
KILLIAN  
for children  
145 mm



**10-102**  
SIMS  
160 mm



**10-103**  
SIMS  
160 mm



10-104 - 107



10-104  
SIMS  
for children  
190 mm

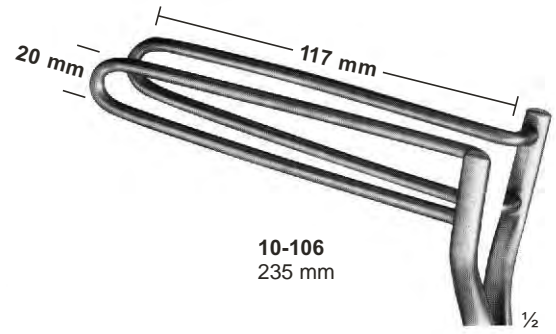

10-106  
235 mm

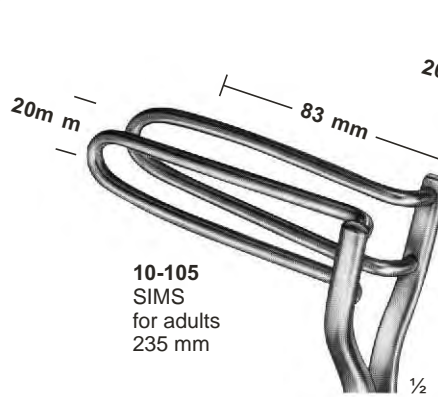

10-105  
SIMS  
for adults  
235 mm

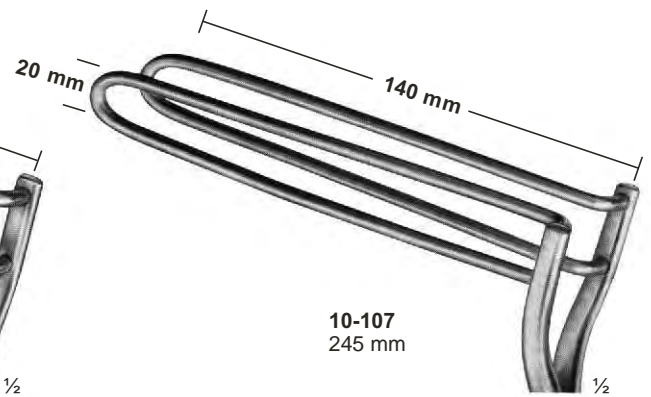

10-107  
245 mm



10-108  
PRATT  
205 mm

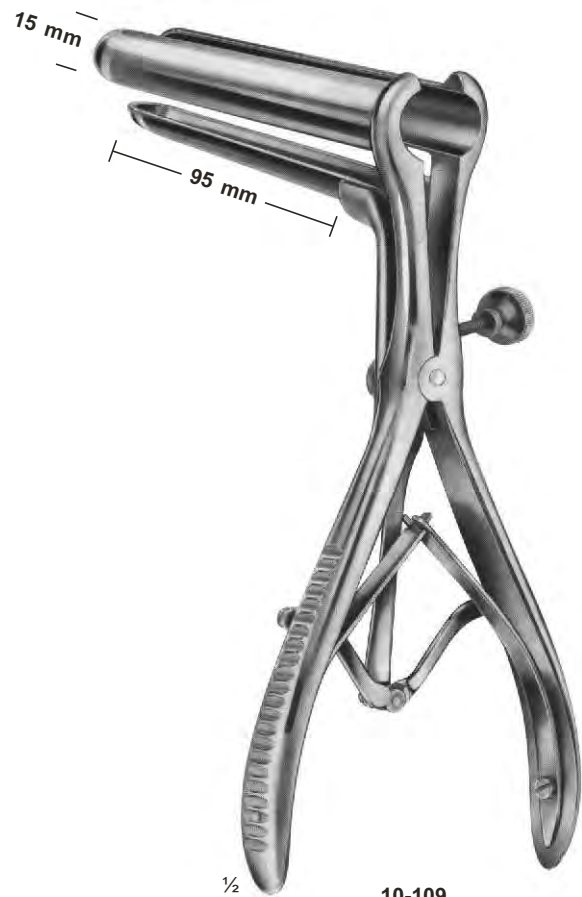

10-109  
MATHIEU  
215 mm



**10-110**  
IVES-FANSLER  
Anuscope  
145 mm



**10-111**  
KELLY  
Sphincteroscope  
160 mm



**10-112**  
KELLY  
Sphincteroscope  
160 mm

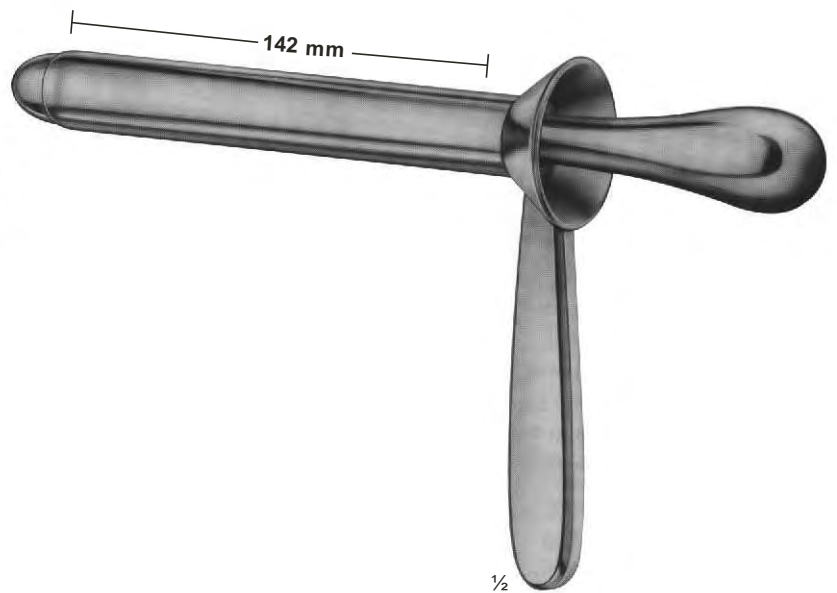

**10-113**  
KELLY  
Proctoscope  
160 mm

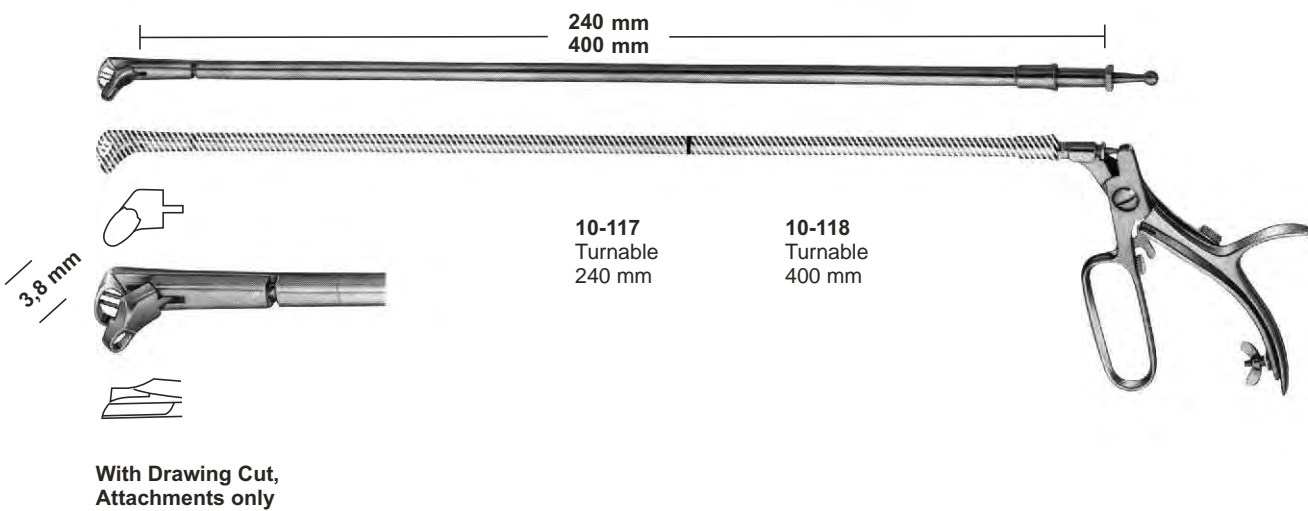
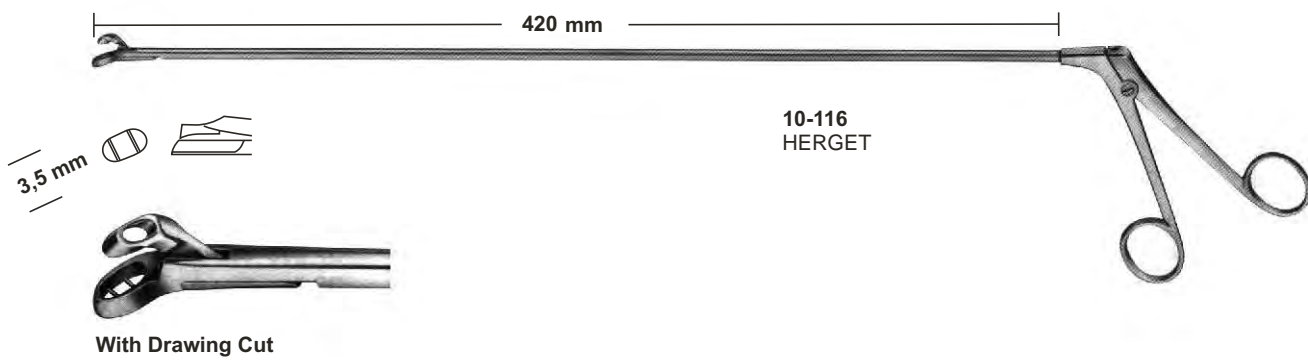
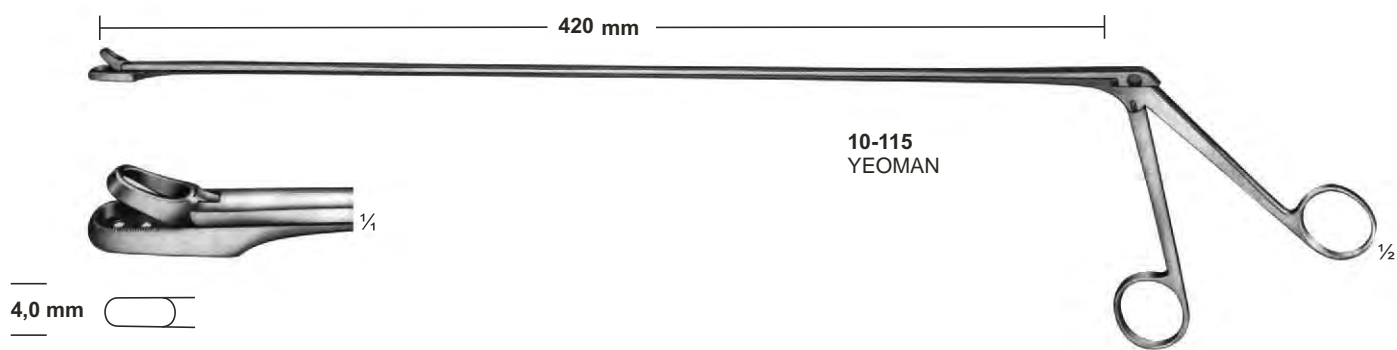
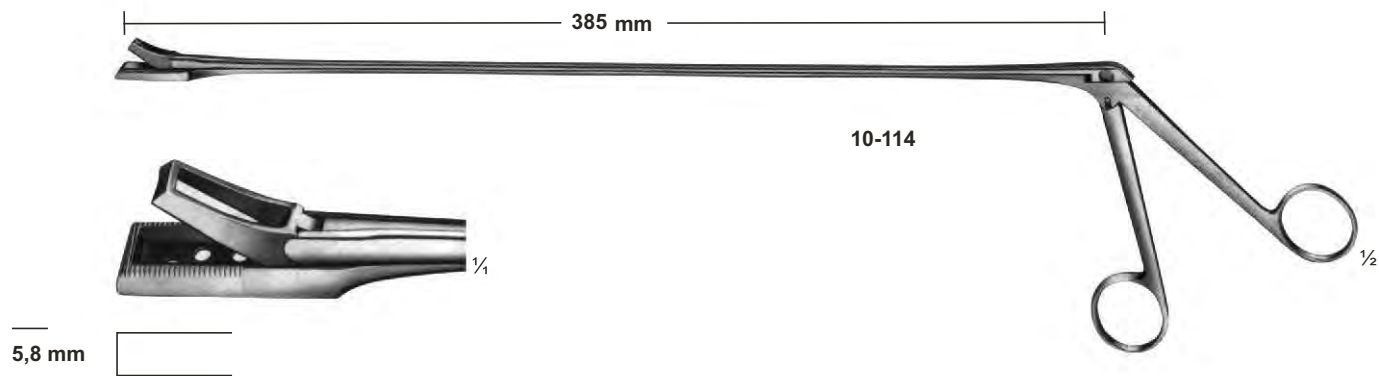



<u>3,5 mm</u>			¼	10-119
<u>3,5 mm</u>			¼	10-120
<u>4,0 mm</u>			¼	10-121
<u>4,0 mm</u>			¼	10-122



**10-119 - 122**  
Handle for 119 - 120 - 121 - 122

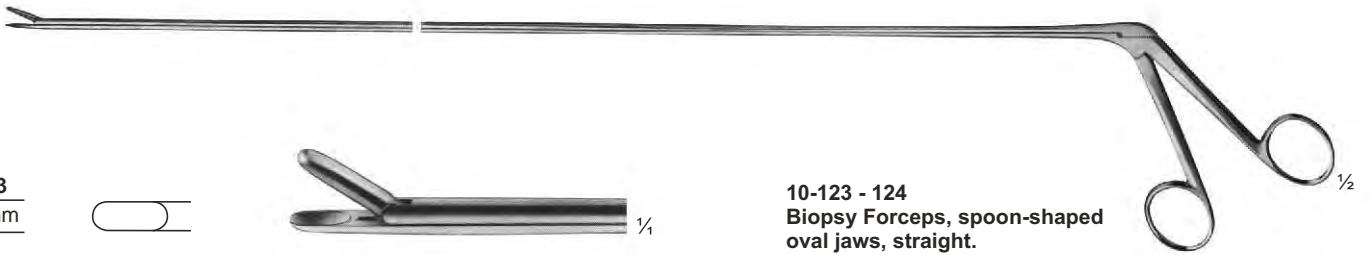

<u>10-123</u> <u>3,5 mm</u>			¼
<u>10-124</u> <u>4, mm</u>			

**10-123 - 124**  
Biopsy Forceps, spoon-shaped oval jaws, straight.

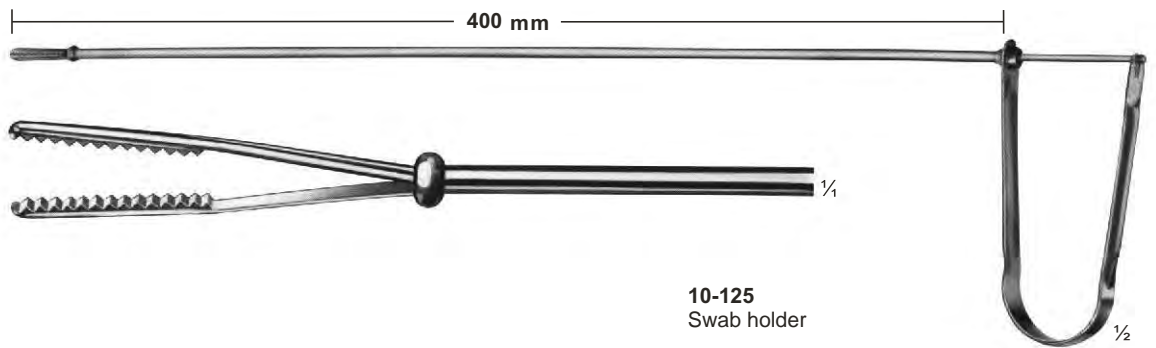

**10-125**  
Swab holder

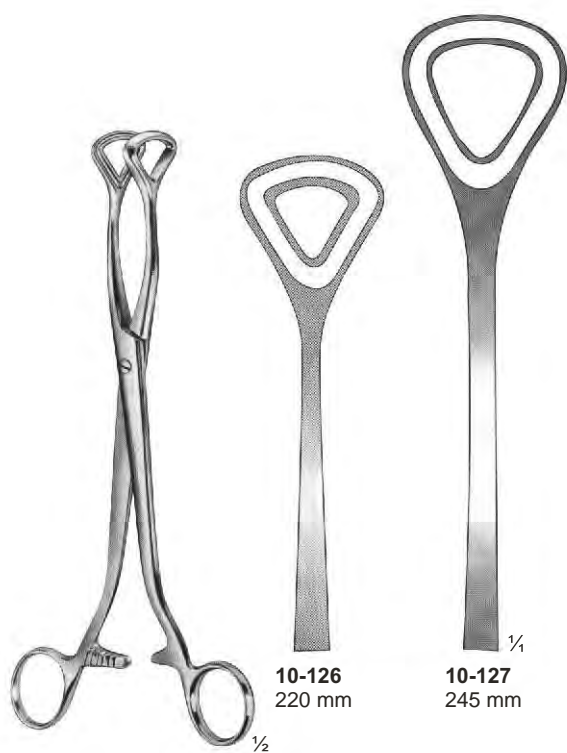

**10-126 - 127**  
LUER

**10-126**  
220 mm

**10-127**  
245 mm

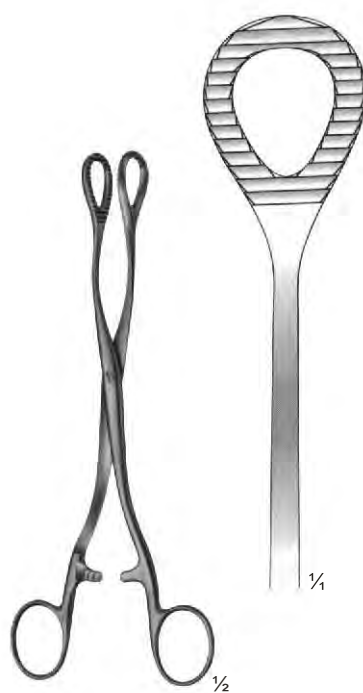

**10-128**  
HEYWOOD-SMITH  
200 mm



**10-129**  
HEYWOOD-SMITH  
modif  
200 mm



10-130

10-131

10-130 - 131  
250 mm  
10-131  
270 mm

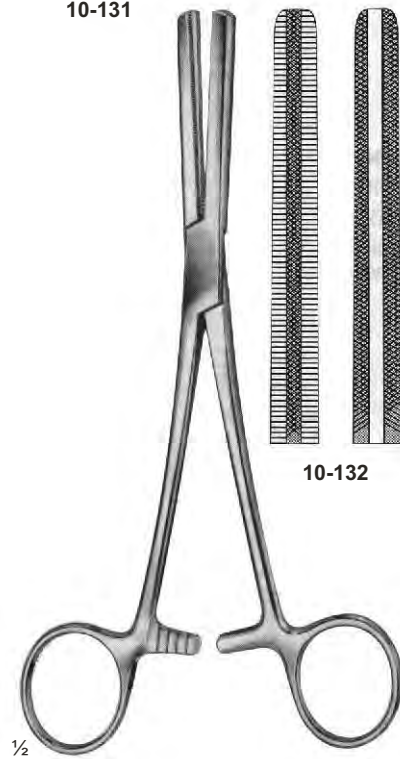

10-132

10-133

10-132 - 133  
FERGUSSON  
200 mm



1/2

10-134  
RUDD  
Haemorrhoidal ligator  
with loading  
attachment and 100  
ligature rubber rings  
315 mm



**10-135**  
LOWER  
180 mm



**10-136**  
LAHEY ( SWEET )  
190 mm



**10-137**  
LAHEY  
220 mm



**10-138**  
DESJARDINS  
Gall duct-and cystic forceps  
210 mm



**10-139**  
NISSEN  
Gall duct-and cystic forceps  
215 mm



**10-140-141**  
GRAY  
180 mm

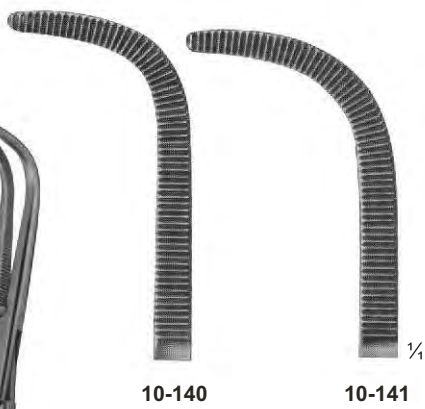

**10-140**

**10-141**



**10-142-143**  
MIXTER  
Gall duct-and cystic forceps  
230 mm

**10-142 10-143**

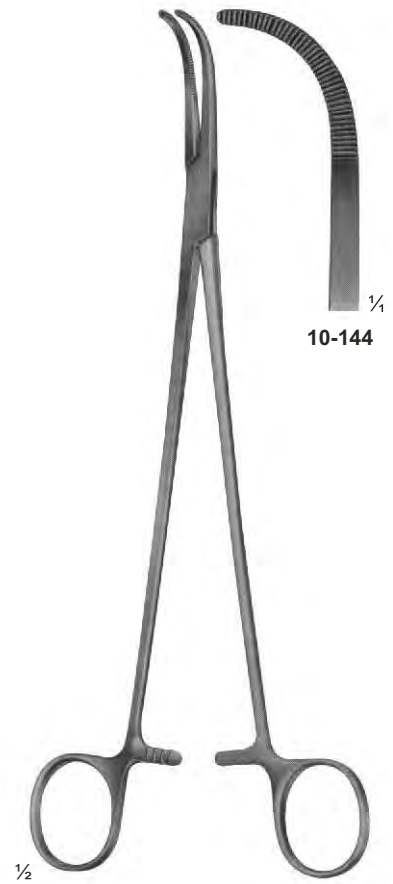

**10-144**  
FOERSTER-BALLENGER  
240 mm

**10-144**

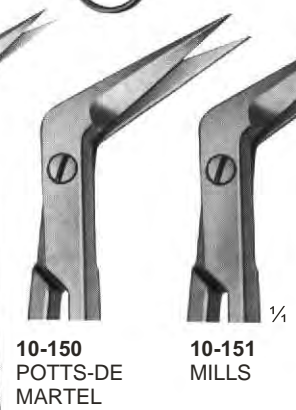
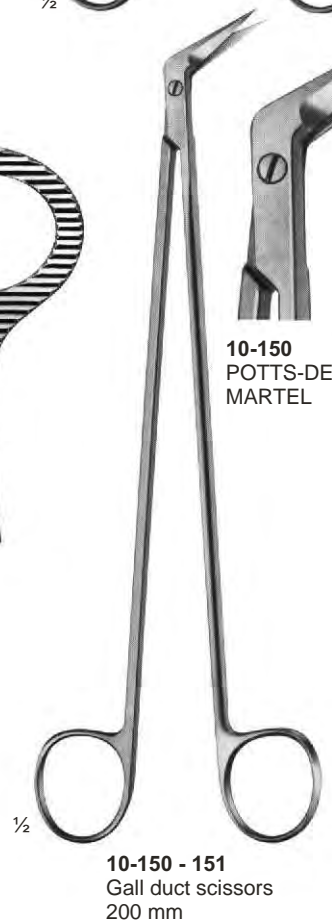
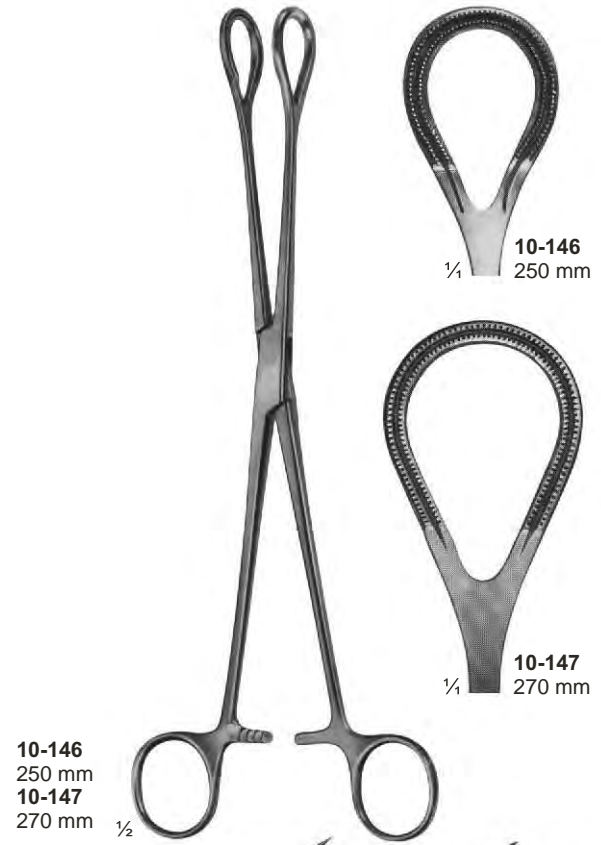
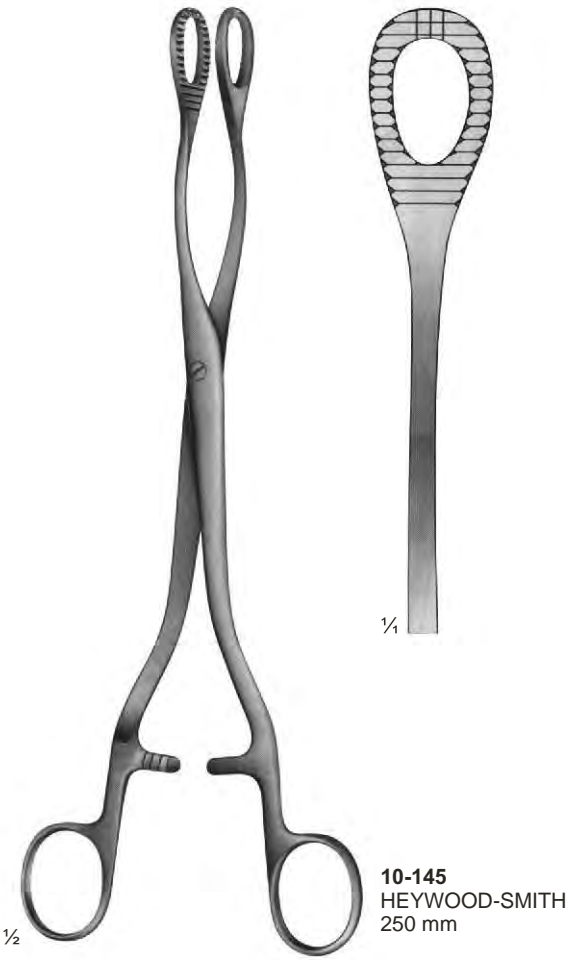

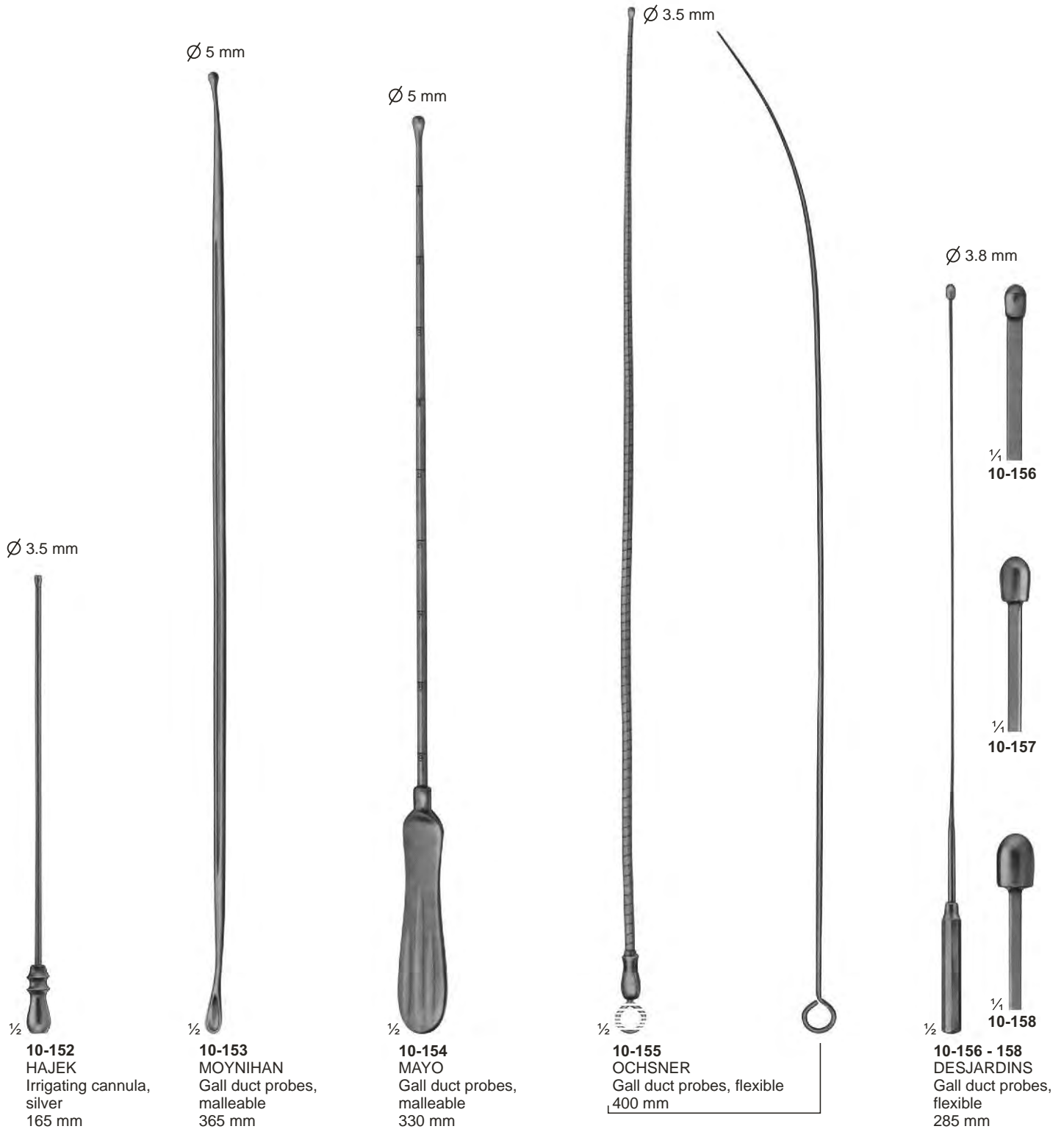

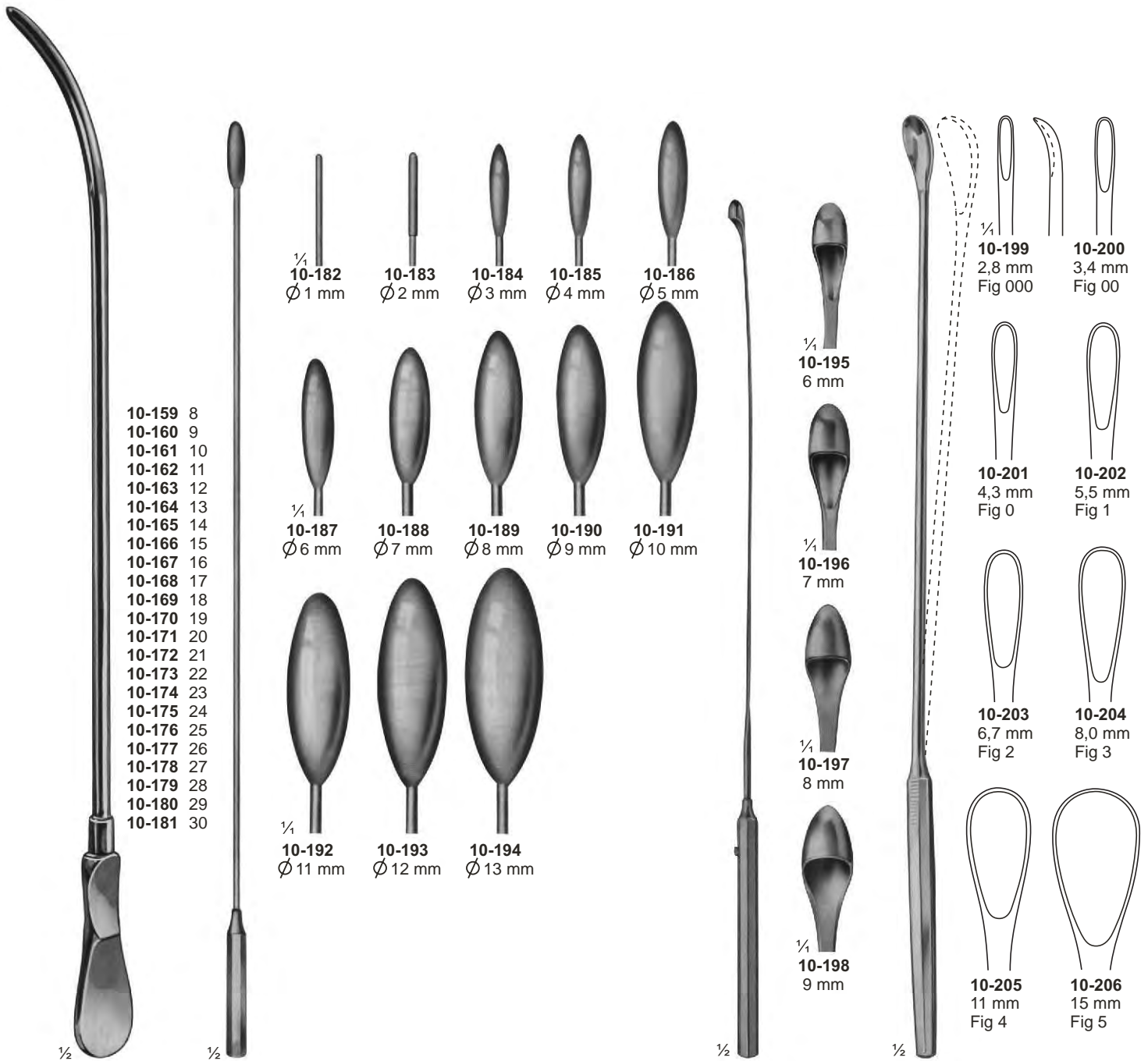

- 10-159 8
- 10-160 9
- 10-161 10
- 10-162 11
- 10-163 12
- 10-164 13
- 10-165 14
- 10-166 15
- 10-167 16
- 10-168 17
- 10-169 18
- 10-170 19
- 10-171 20
- 10-172 21
- 10-173 22
- 10-174 23
- 10-175 24
- 10-176 25
- 10-177 26
- 10-178 27
- 10-179 28
- 10-180 29
- 10-181 30

- 1/4 10-182  
Ø 1 mm
- 10-183  
Ø 2 mm
- 10-184  
Ø 3 mm
- 10-185  
Ø 4 mm
- 10-186  
Ø 5 mm
- 1/4 10-187  
Ø 6 mm
- 10-188  
Ø 7 mm
- 10-189  
Ø 8 mm
- 10-190  
Ø 9 mm
- 10-191  
Ø 10 mm
- 1/4 10-192  
Ø 11 mm
- 10-193  
Ø 12 mm
- 10-194  
Ø 13 mm

- 1/4 10-195  
6 mm
- 1/4 10-196  
7 mm
- 1/4 10-197  
8 mm
- 1/4 10-198  
9 mm
- 1/4 10-199  
2,8 mm  
Fig 000
- 10-200  
3,4 mm  
Fig 00
- 10-201  
4,3 mm  
Fig 0
- 10-202  
5,5 mm  
Fig 1
- 10-203  
6,7 mm  
Fig 2
- 10-204  
8,0 mm  
Fig 3
- 10-205  
11 mm  
Fig 4
- 10-206  
15 mm  
Fig 5

**10-159 - 181**  
DITTEL  
Metall bougies and dilating sounds, stiff 345 mm

**10-182 - 194**  
BAKES  
Common bile duct dilators, malleable 315 mm, 320 mm

**10-195 - 198**  
DESJARDINS  
Probes and catch with flexible schaft 300 mm

**10-199 - 206**  
LUER-KORTE modif  
with malleable shaft 310 mm

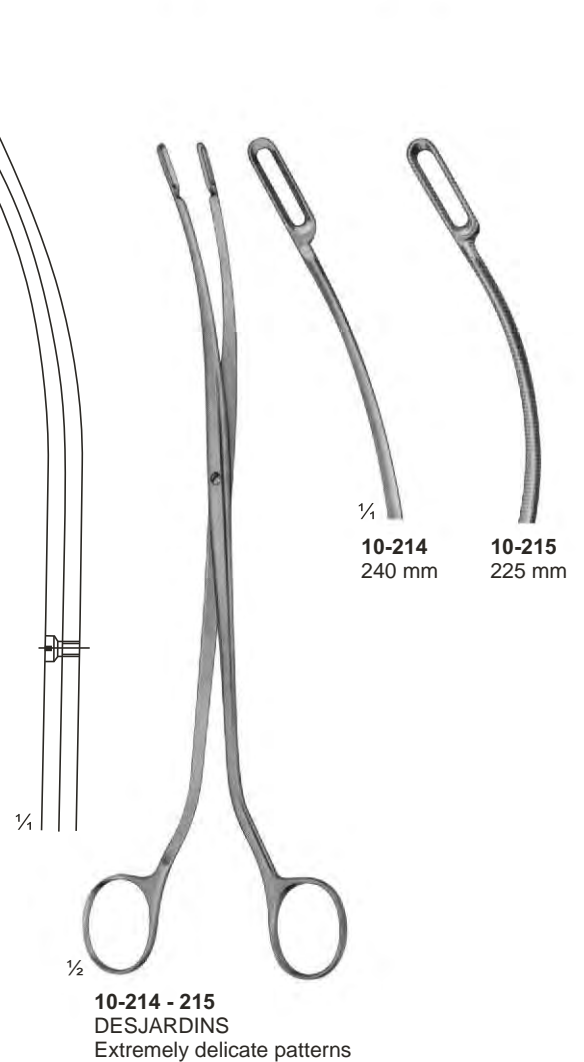
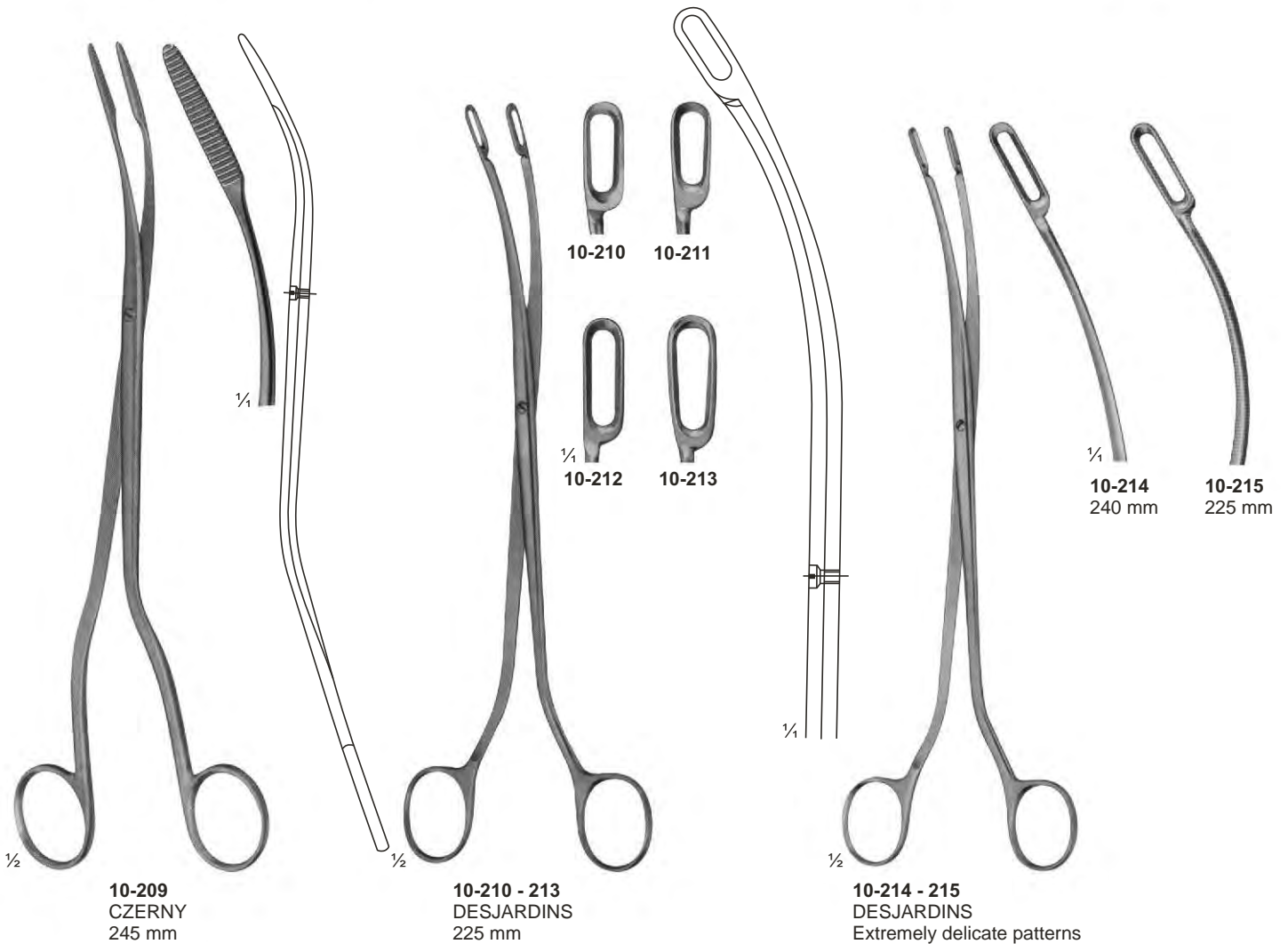
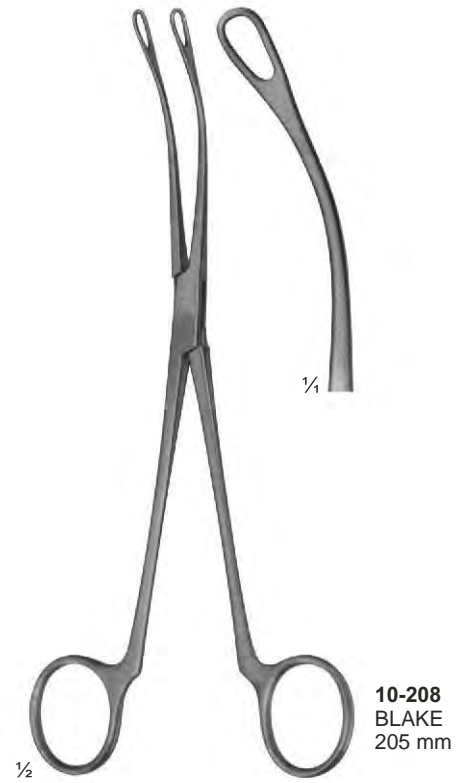
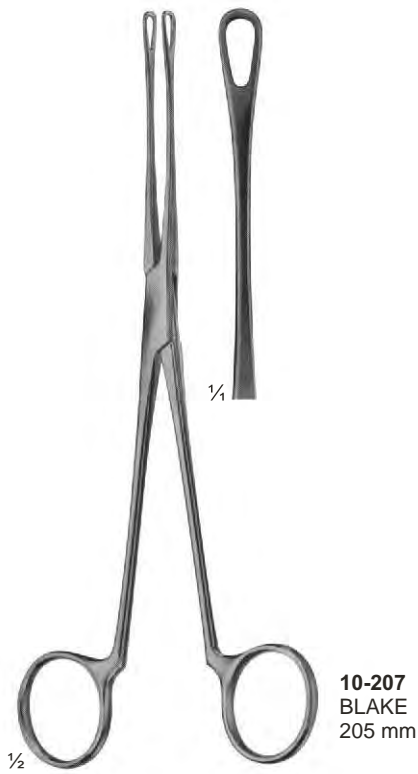

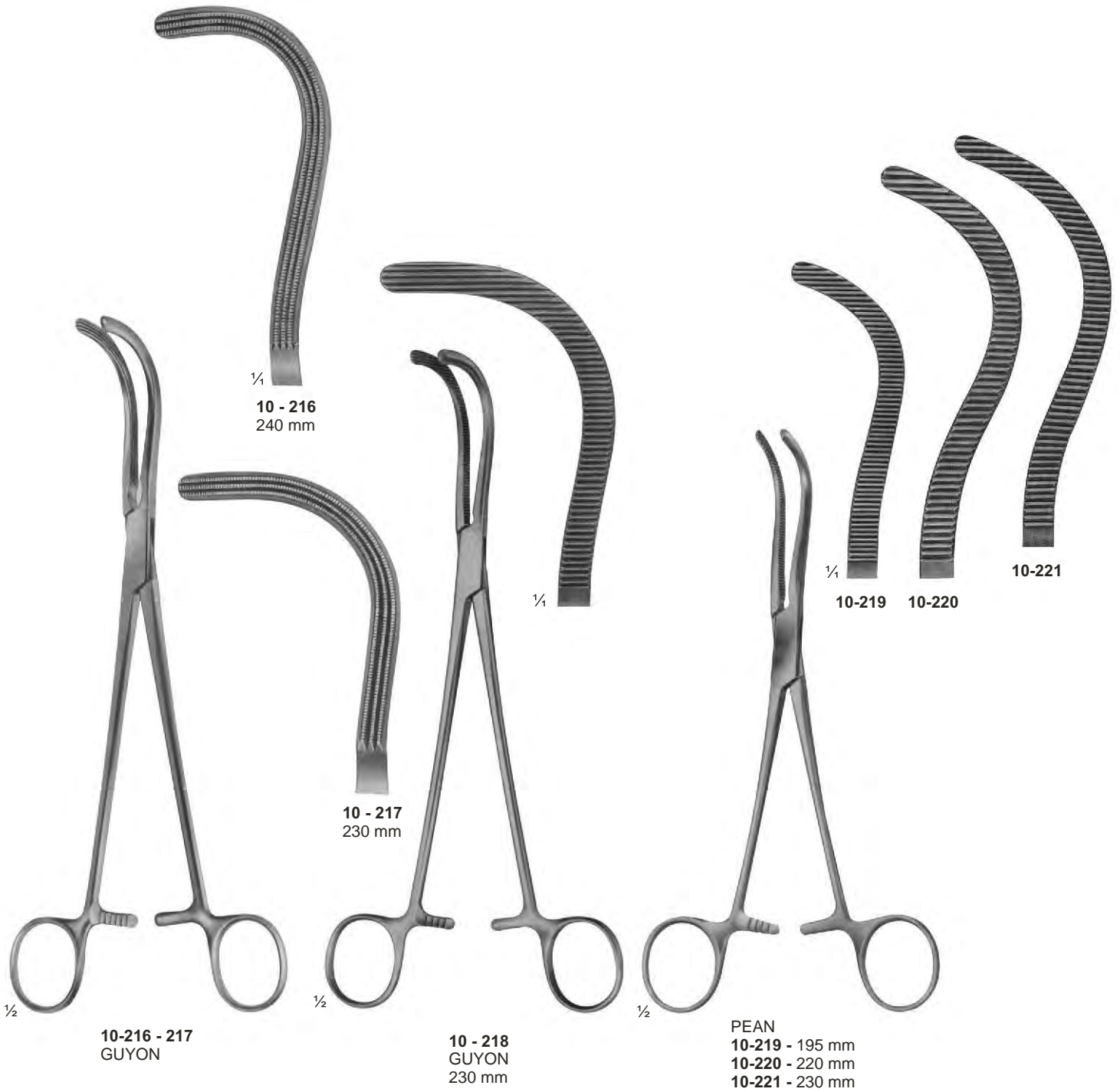

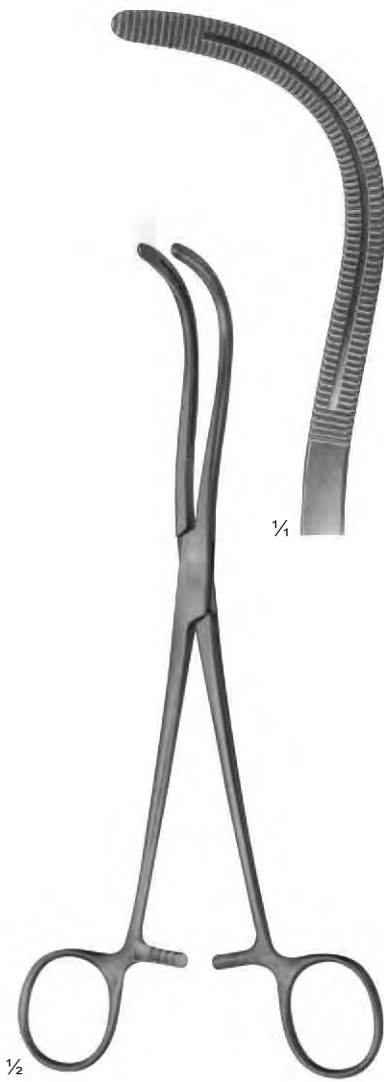

**10-222**  
STILLE  
220 mm

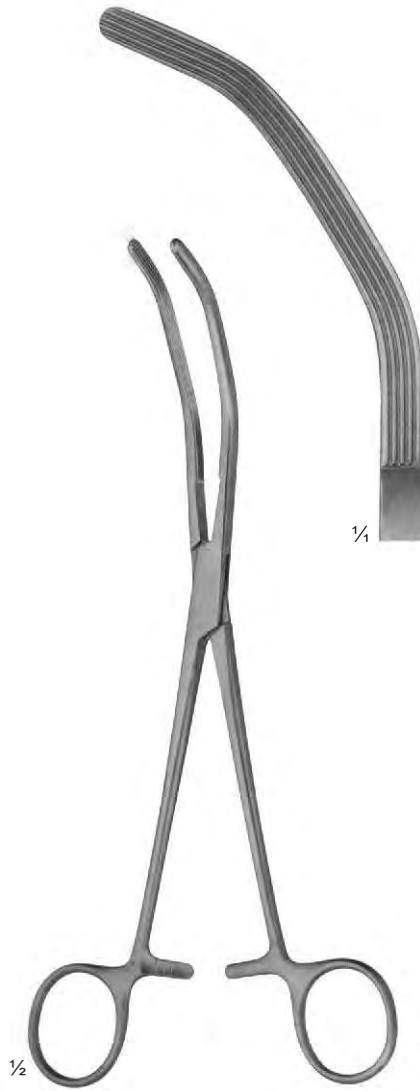

**10-223**  
HERRICK  
225 mm

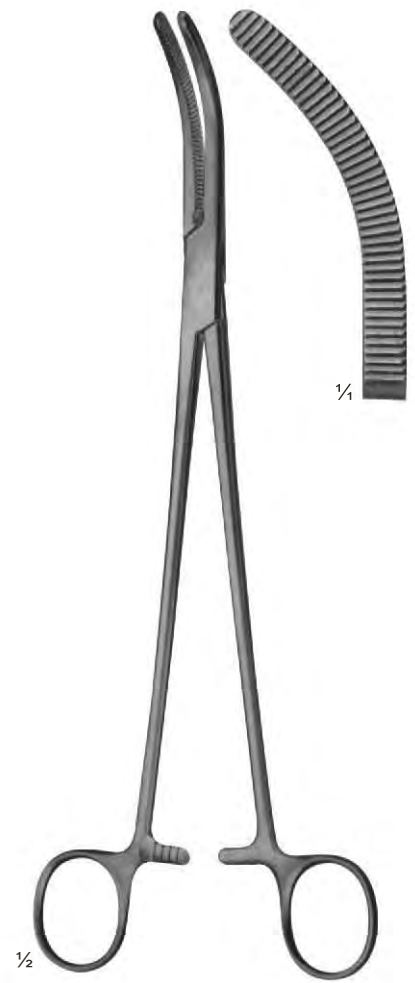

**10-224**  
WERTHEIM  
225 mm



½

**10-225**  
COLLIN  
285 mm



½

**10-226**  
DARTIGUES  
255 mm



10-227



10-228



10-229



$\frac{1}{4}$   
10-230



10-231



10-232



$\frac{1}{4}$   
10-233



$\frac{1}{2}$

10-227 - 230  
RANDALL  
225 mm



$\frac{1}{2}$

10-231 - 233  
RANDALL  
190 mm

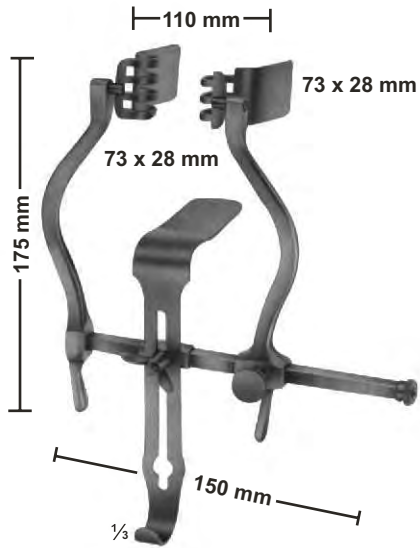

**11-101**  
**JUDD-MASSON**  
 Bladder and suprapubic  
 retractor



**11-102**  
**MILLIN**  
 Bladder retractor  
 105X45 mm



**11-103**  
**LEGUEU**  
 Bladder retractor  
 Center blade  
 80 x 31 mm

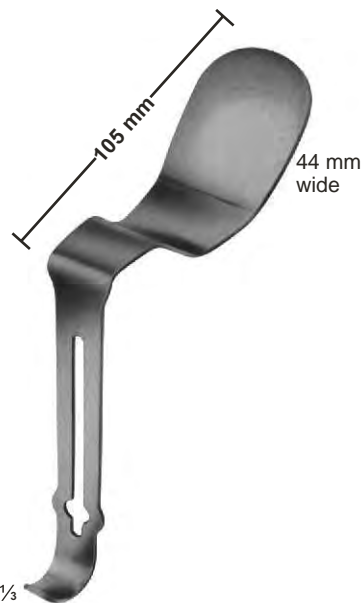

**11-104**  
**MILLIN**  
 Center bladder for  
 retro pubic prostatectomy



**11-105**  
**KOCHER**  
 Bladder spatula  
 235 mm



**11-106**  
MATHIEU  
Foreign body forceps  
Length of shaft  
190 mm

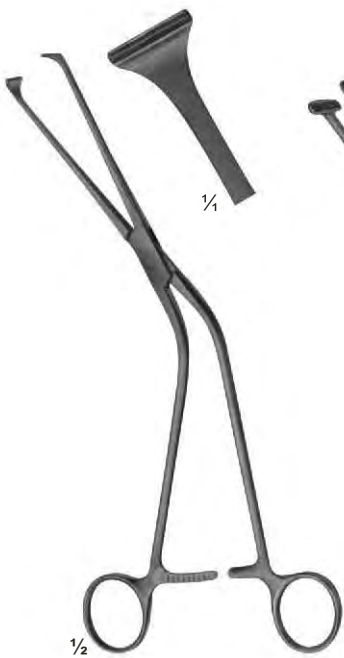

**11-107**  
MILLIN  
Lobe grasping  
forceps  
245 mm

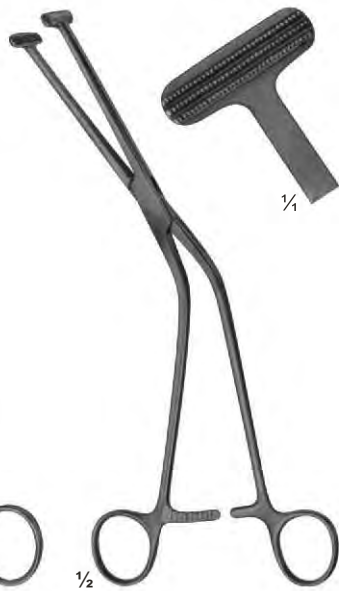

**11-108**  
MILLIN  
Lobe grasping  
forceps  
235 mm



**11-109**  
MILLIN  
Bladder neck spreader  
285 mm

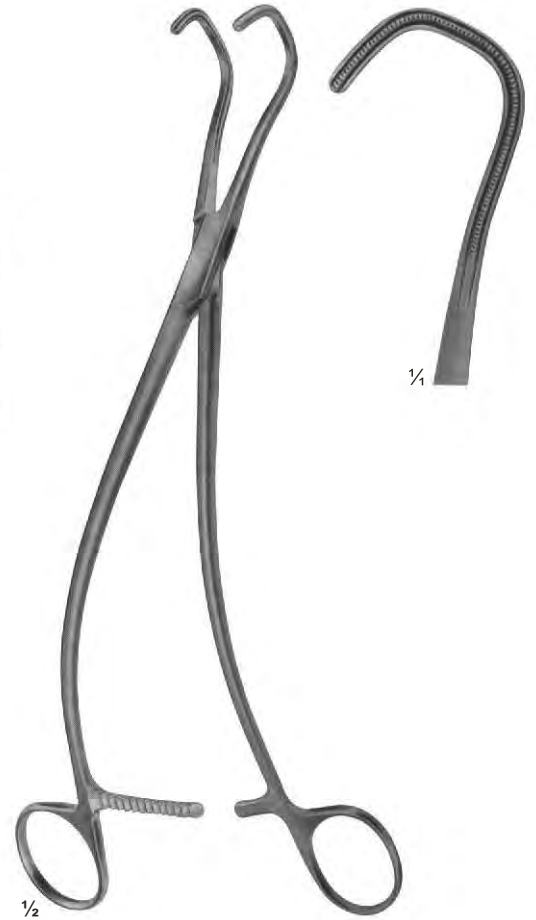

**11-110**  
Ureter forceps  
240 mm



**11-111**  
GUYON  
Catheter guide  
(introducer)  
365 mm



- 11-112 6
- 11-113 7
- 11-114 8
- 11-115 9
- 11-116 10
- 11-117 11
- 11-118 12
- 11-119 13
- 11-120 14
- 11-121 15
- 11-122 16
- 11-123 18
- 11-124 20

**11-112 - 124**  
Female catheters,  
metal  
160 mm



- 11-125 8
- 11-126 9
- 11-127 10
- 11-128 11
- 11-129 12
- 11-130 13
- 11-131 14
- 11-132 15
- 11-133 16
- 11-134 17
- 11-135 18
- 11-136 19
- 11-137 20
- 11-138 21
- 11-139 22
- 11-140 23
- 11-141 24
- 11-142 25
- 11-143 26
- 11-144 27
- 11-145 28
- 11-146 29
- 11-147 30

**11-125 - 147**  
Urethral bougies  
and dilating sounds  
345 mm

- 11-148 Ben. 24/Charr. 12
- 11-149 Ben. 25
- 11-150 Ben. 26/Charr. 13
- 11-151 Ben. 27
- 11-152 Ben. 28/Charr. 14
- 11-153 Ben. 29
- 11-154 Ben. 30/Charr. 15
- 11-155 Ben. 31
- 11-156 Ben. 32/Charr. 16
- 11-157 Ben. 33
- 11-158 Ben. 34/Charr. 17
- 11-159 Ben. 35
- 11-160 Ben. 36/Charr. 18
- 11-161 Ben. 37
- 11-162 Ben. 38/Charr. 19
- 11-163 Ben. 39
- 11-164 Ben. 40/Charr. 20
- 11-165 Ben. 41
- 11-166 Ben. 42/Charr. 21
- 11-167 Ben. 43
- 11-168 Ben. 44/Charr. 22
- 11-169 Ben. 45
- 11-170 Ben. 46/Charr. 23
- 11-171 Ben. 47
- 11-172 Ben. 48/Charr. 24
- 11-173 Ben. 49
- 11-174 Ben. 50/Charr. 25
- 11-175 Ben. 51
- 11-176 Ben. 52/Charr. 26
- 11-177 Ben. 53
- 11-178 Ben. 54/Charr. 27
- 11-179 Ben. 55
- 11-180 Ben. 56/Charr. 28
- 11-181 Ben. 57
- 11-182 Ben. 58/Charr. 29
- 11-183 Ben. 59
- 11-184 Ben. 60/Charr. 30

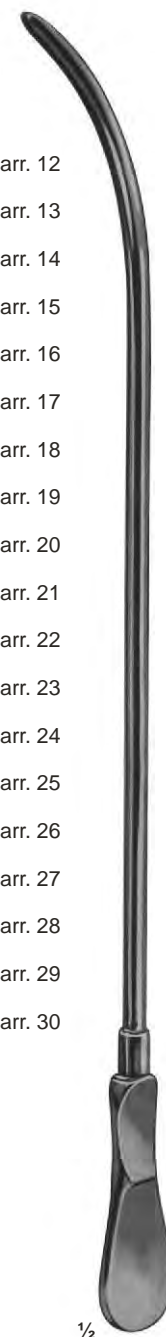

**11-148 - 184**  
Urethral bougies  
and dilating sounds  
255 mm



**11-185**  
**GUYON**  
Set of urethral bougies and dilating sounds,  
in metal case, with lift out rack and bottom  
rack, containing 21 urethral and dilating sounds.



**11-186**  
**WINKELMANN**

12 mm / 16 mm / 20 mm



**11-187**  
KLIMA ROSEGGER  
35 X 1,8 mm  
Sternal puncture needle

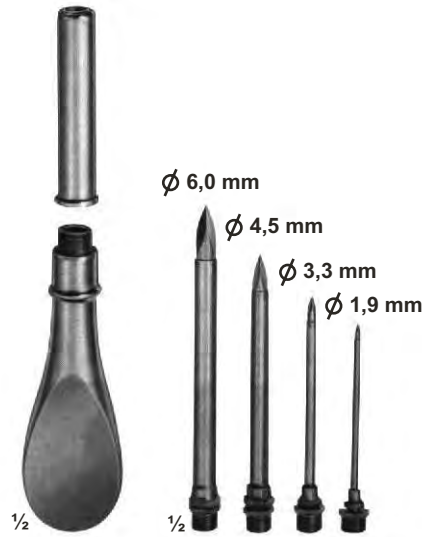

**11-188**  
Universal trocar  
with 4 tips



**11-189 - 193**  
Inside dime. Outside dime  
**11-189** 2,2 mm 3,0 mm  
**11-190** 3,0 mm 4,0 mm  
**11-191** 4,0 mm 5,0 mm  
**11-192** 5,0 mm 6,0 mm  
**11-193** 5,5 mm 6,5 mm  
for hydrocele and abdominal puncture



**11-194 - 197**  
Inside dime. Outside dime  
**11-194** 2,2 mm 3,0 mm  
**11-195** 3,0 mm 4,0 mm  
**11-196** 4,0 mm 5,0 mm  
**11-197** 5,0 mm 6,0 mm  
for abdominal puncture,  
with stop-cock and lateral drain

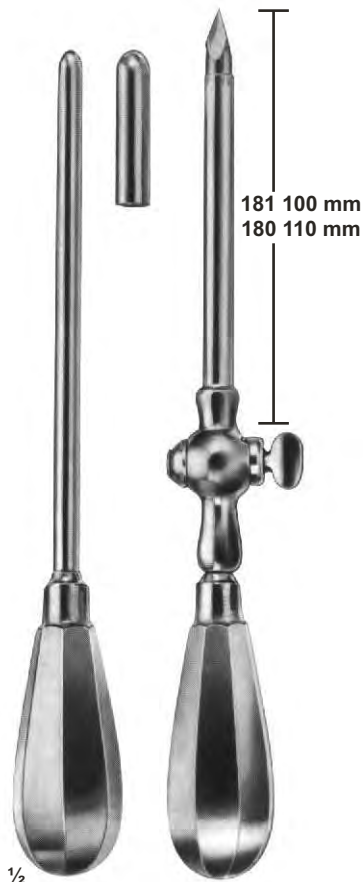

**11-198 - 199**  
Inside dime. Outside dime  
**11-198** 6,5 mm 8,0 mm  
**11-199** 9,0 mm 10,0 mm  
Empyema trocar

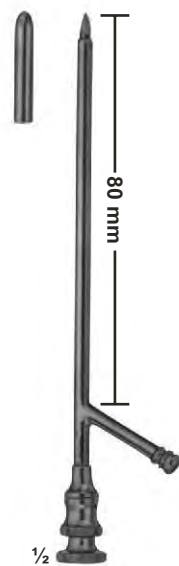

**11-200 - 203**  
Inside dime. Outside dime  
**11-200** 3,0 mm 4,0 mm  
**11-201** 3,6 mm 4,6 mm  
**11-202** 4,3 mm 5,3 mm  
**11-203** 5,0 mm 6,0 mm  
Gall bladder trocars



**11-204**  
PIERCE  
Antrum trocar  
4,0 mm



**11-205**  
COAKLEY  
Antrum trocar  
3,0 mm



**12-101**  
COLLIN  
for children  
53 x 10 mm

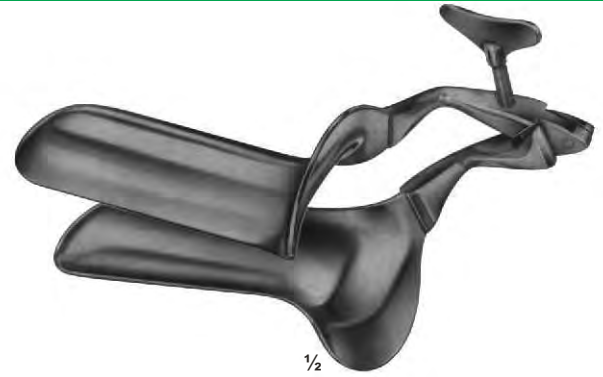

**12-102 - 105**  
COLLIN

<b>12-102</b>	100/90mm	28 mm
<b>12-103</b>	100/90mm	32 mm
<b>12-104</b>	105/95mm	35 mm
<b>12-105</b>	115/105mm	40 mm
Total length/working length		width



**12-106**  
COLLIN  
for virgins  
95/85 x 18 mm



**12-107**  
CUSCO  
for virgins  
75 x17 mm



**12-108**  
CUSCO  
for virgins  
75 x17 mm



**12-109 - 111**  
CUSCO

<b>12-109</b>	92X23-25 mm
<b>12-110</b>	100x25-27 mm
<b>12-111</b>	110x27-30 mm



1/2

**12-112 - 115**  
CUSCO  
STANDARD  
**12-112** 80X24 mm  
**12-113** 80X32 mm  
**12-114** 90X36 mm  
**12-115** 110X37 mm



1/2

**12-116 - 119**  
CUSCO  
**12-116** 80X24 mm  
**12-117** 80X32 mm  
**12-118** 90X36 mm  
**12-119** 110X37 mm



1/2

**12-120 - 122**  
CUSCO  
**12-120** 80X24 mm  
**12-121** 80X32 mm  
**12-122** 115X36 mm



1/2

**12-123 - 124**  
SEYFFERT  
**12-123** 100X24 mm  
**12-124** 110X32 mm  
230 mm



1/2

**12-125**  
SEMM  
for children  
and virgins  
180 mm



**12-126 - 128**  
GRAVE  
12-126 75X20 mm  
12-127 95X30 mm  
12-128 105X33 mm

1/2



**12-129 - 130**  
PEDERSON  
12-129 100X22 mm  
12-130 120X25 mm

1/2



**12-131 - 132**  
BRIESKY  
12-131 72X25 mm / 77X30 mm  
12-132 75X30 mm / 92X38 mm  
170 mm

1/2



1/2

**12-133 - 134**  
BREISKY  
12-133 100X22 mm  
77 X30 mm  
140 mm  
12-134 120X25 mm  
92 X38 mm  
170 mm

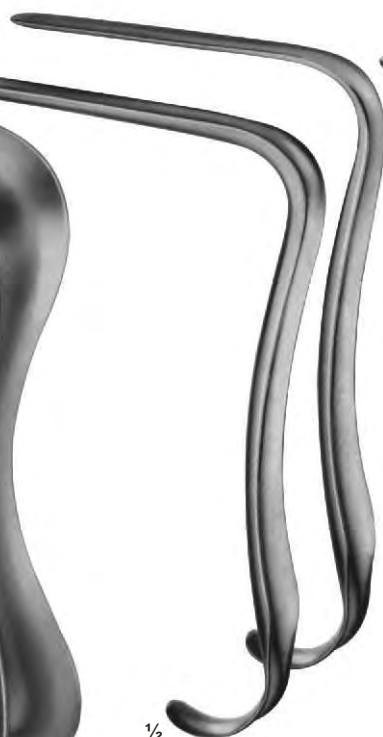

1/2

**12-135 - 137**  
SEIDL  
12-135 80X8 mm  
12-136 80X10 mm  
12-137 90X14 mm  
For children and infants  
170 mm



1/2

**12-138**  
KRISTELLER  
70X15 mm, ( 170 mm )  
For children



1/2

**12-139 - 141**  
SIMS  
12-139 70X26 mm  
75 X30 mm 125 mm  
12-140 75X30 mm  
80 X85 mm 150 mm  
11-141 80X36 mm  
90 X40 mm 175 mm



**12-147** 75X10 mm  
175 mm

**12-151** 70X15 mm  
175 mm

**12-148** 75X23 mm  
180 mm

**12-152** 70X27 mm  
180 mm

**12-149** 80X25 mm  
180 mm

**12-153** 75X30 mm  
180 mm

**12-150** 100X32 mm  
185 mm

**12-154** 90X36 mm  
185 mm

1/2

1/2

1/2

**12-142 - 146**  
KRISTELLER  
12-142 110X18 mm  
12-143 110X20 mm  
12-144 110X27 mm  
12-145 110X30 mm  
12-146 110X36 mm  
220 mm

**12-147 - 150**  
KRISTELLER  
Upper blades

**12-151 - 154**  
KRISTELLER  
Lower blades



**12-155** 115X14 mm  
215 mm

**12-156** 115X23 mm  
215 mm

**12-157** 115X16 mm  
220 mm

**12-158** 115X26 mm  
220 mm

**12-159** 120X30 mm  
225 mm

**12-155 - 159**  
KRISTELLER  
Upper blades

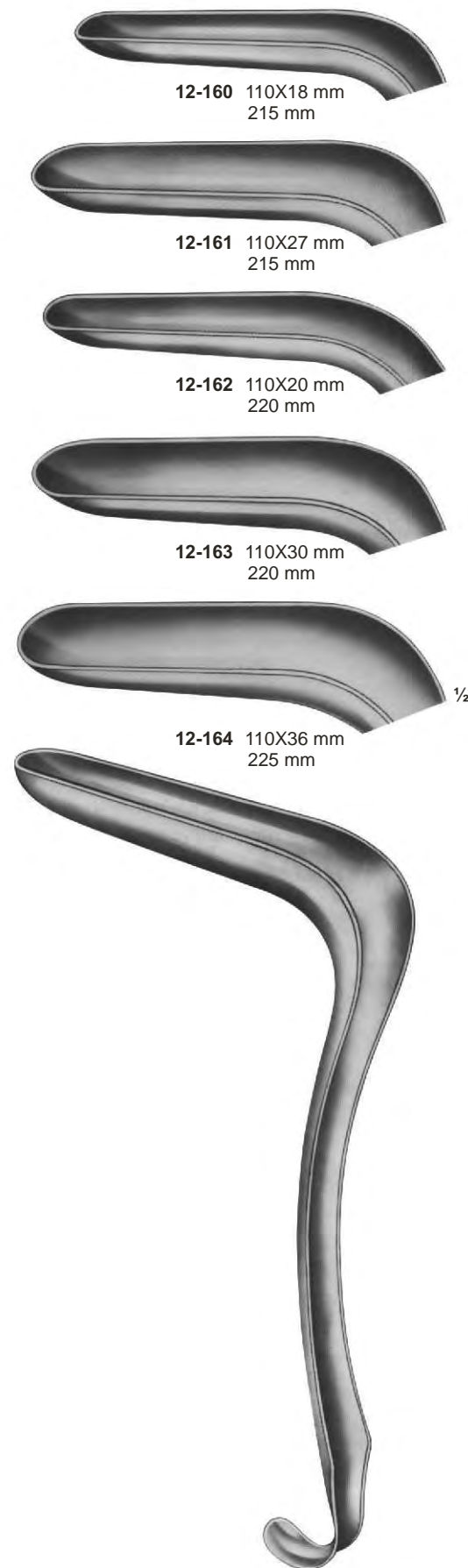

**12-160** 110X18 mm  
215 mm

**12-161** 110X27 mm  
215 mm

**12-162** 110X20 mm  
220 mm

**12-163** 110X30 mm  
220 mm

**12-164** 110X36 mm  
225 mm

**12-160 - 164**  
KRISTELLER  
Lower blades



**12-165**  
80 X 28 mm



**12-166**  
85 X 35 mm

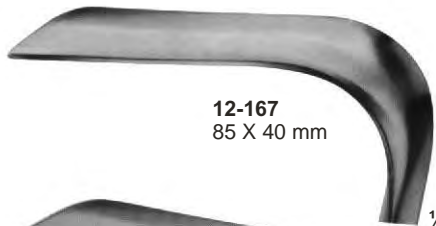

**12-167**  
85 X 40 mm



Slightly Concave

1/2

**12-165 - 167**  
KRISTELLER  
205 mm

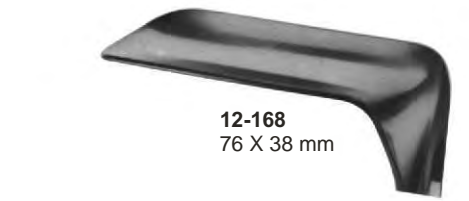

**12-168**  
76 X 38 mm



**12-169**  
89 X 38 mm

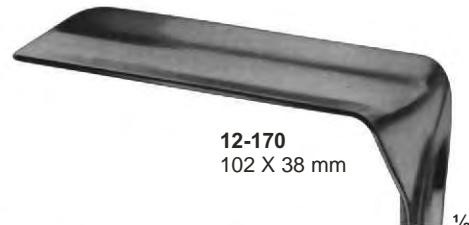

**12-170**  
102 X 38 mm



Slightly Concave

1/2

**12-168 - 170**  
JACKSON  
175 mm







1/2

**12-190 - 194**  
**BREISKY**  
 WIENER MODELL/  
 VIENNA PATTERN  
**12-190** 100 X 20 mm  
**12-191** 100 X 25 mm  
**12-192** 100 X 30 mm  
**12-193** 100 X 35 mm  
**12-194** 100 X 40 mm  
 300 mm



1/2

**12-195 - 199**  
**BREISKY**  
 WIENER MODELL/  
 VIENNA PATTERN  
**12-195** 130 X 20 mm  
**12-196** 130 X 25 mm  
**12-197** 130 X 30 mm  
**12-198** 130 X 35 mm  
**12-199** 130 X 40 mm  
 320 mm



1/2

**12-200 - 201**  
**WEISSBARTH**  
**12-200** 80 X 28 mm  
**12-201** 85 X 42 mm  
 210 mm



1/2

**12-202**  
**DOYEN**  
 lateral speculum  
 80 x 30 mm  
 250 mm



**12-203**  
SIMON  
115 X 22 mm  
275 mm



**12-204**  
AUVARD  
65 X 38 mm - 28 mm  
1,530 kg  
with fixed weight  
230 mm



**12-205 - 206**  
AUVARD  
**12-205** 75 X 42 mm  
( 40 mm )  
**12-206** 105 X 43 mm  
( 40 mm )  
with detachable wight  
230 mm



**12-207**  
MARTIN  
with hook shaped  
handle for hanging  
in weights  
270 mm

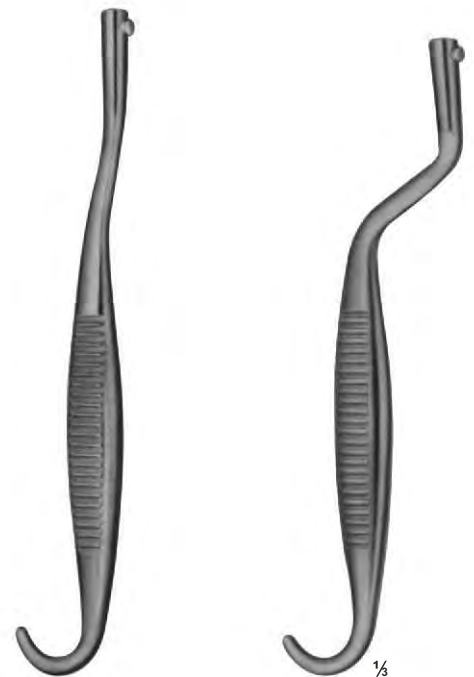
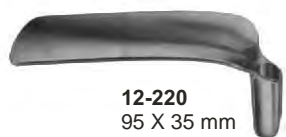
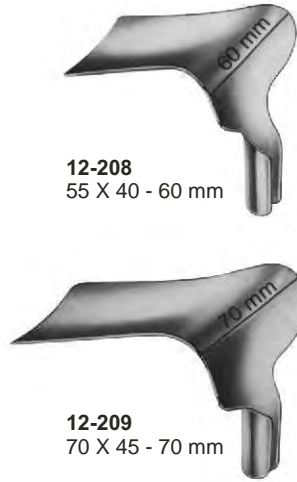



1/2  
**12-221**  
 JOLL (FRIEDMAN)  
 155 mm



1/2  
**12-222**  
 RICHTER  
 170 mm



1/2  
**12-223**  
 GELPI  
 135 mm



1/2  
**12-224**  
 GELPI  
 175 mm



<b>13-101</b>	1	mm	<b>13-123</b>	23	mm
<b>13-102</b>	2	mm	<b>13-124</b>	24	mm
<b>13-103</b>	3	mm	<b>13-125</b>	25	mm
<b>13-104</b>	4	mm	<b>13-126</b>	26	mm
<b>13-105</b>	5	mm	<b>13-127</b>	1	½mm
<b>13-106</b>	6	mm	<b>13-128</b>	2	½mm
<b>13-107</b>	7	mm	<b>13-129</b>	3	½mm
<b>13-108</b>	8	mm	<b>13-130</b>	4	½mm
<b>13-109</b>	9	mm	<b>13-131</b>	5	½mm
<b>13-110</b>	10	mm	<b>13-132</b>	6	½mm
<b>13-111</b>	11	mm	<b>13-133</b>	7	½mm
<b>13-112</b>	12	mm	<b>13-134</b>	8	½mm
<b>13-113</b>	13	mm	<b>13-135</b>	9	½mm
<b>13-114</b>	14	mm	<b>13-136</b>	10	½mm
<b>13-115</b>	15	mm	<b>13-137</b>	11	½mm
<b>13-116</b>	16	mm	<b>13-138</b>	12	½mm
<b>13-117</b>	17	mm	<b>13-139</b>	13	½mm
<b>13-118</b>	18	mm	<b>13-140</b>	14	½mm
<b>13-119</b>	19	mm	<b>13-141</b>	15	½mm
<b>13-120</b>	20	mm	<b>13-142</b>	16	½mm
<b>13-121</b>	21	mm	<b>13-143</b>	17	½mm
<b>13-122</b>	22	mm			

**13-101 - 143**  
HEGAR  
with very conical point  
185 mm



<b>13-144</b>	1+2	mm
<b>13-145</b>	3+4	mm
<b>13-146</b>	5+6	mm
<b>13-147</b>	7+8	mm
<b>13-148</b>	9+10	mm
<b>13-149</b>	11+12	mm
<b>13-150</b>	13+14	mm
<b>13-151</b>	15+16	mm
<b>13-152</b>	17+18	mm

**13-144 - 152**  
HEGAR  
205 mm

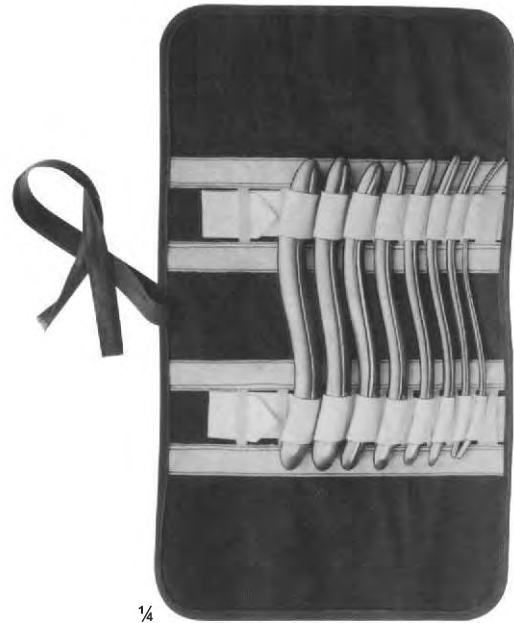

**13-153**  
HEGAR  
Uterine dilator set, in canvas  
roll with 8 dilators.



**13-154**  
HEGAR  
Dilator set consisting of:  
14 Dilators,  
1 Rack for dilators ( 4 - 12 mm )  
1 Rack for Dilators ( 13 - 17 mm )  
1 Metal case only,  
with hinged lid, stainless 200 X 100 X 35 mm

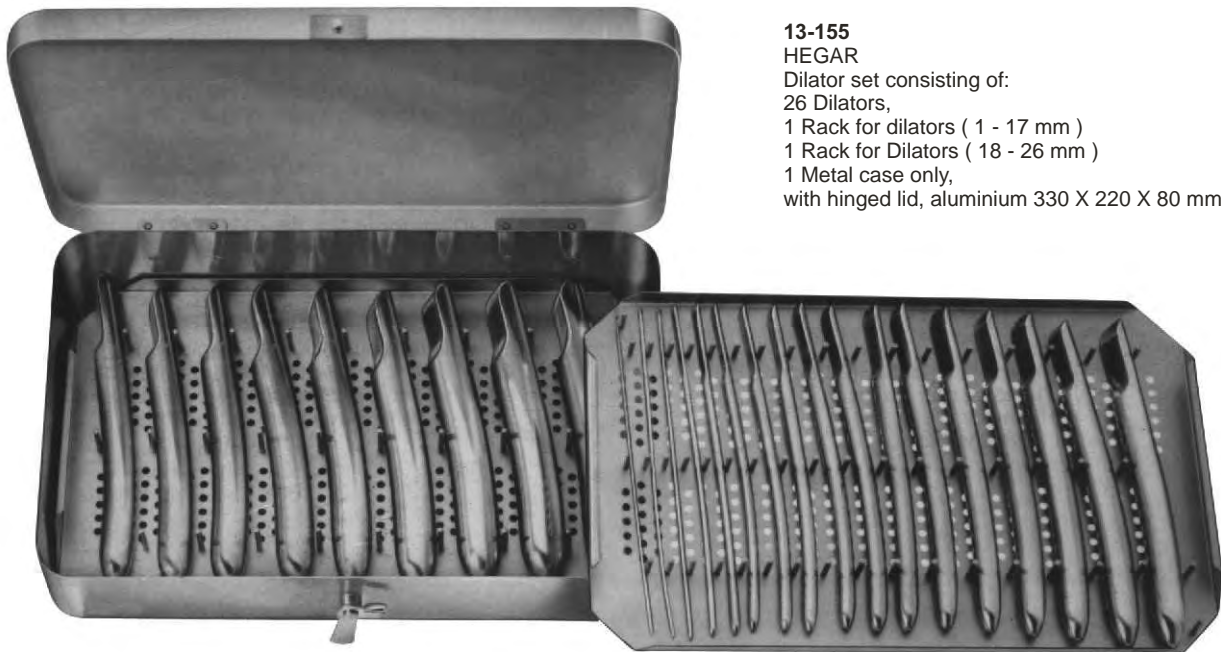

**13-155**  
HEGAR  
Dilator set consisting of:  
26 Dilators,  
1 Rack for dilators ( 1 - 17 mm )  
1 Rack for Dilators ( 18 - 26 mm )  
1 Metal case only,  
with hinged lid, aluminium 330 X 220 X 80 mm

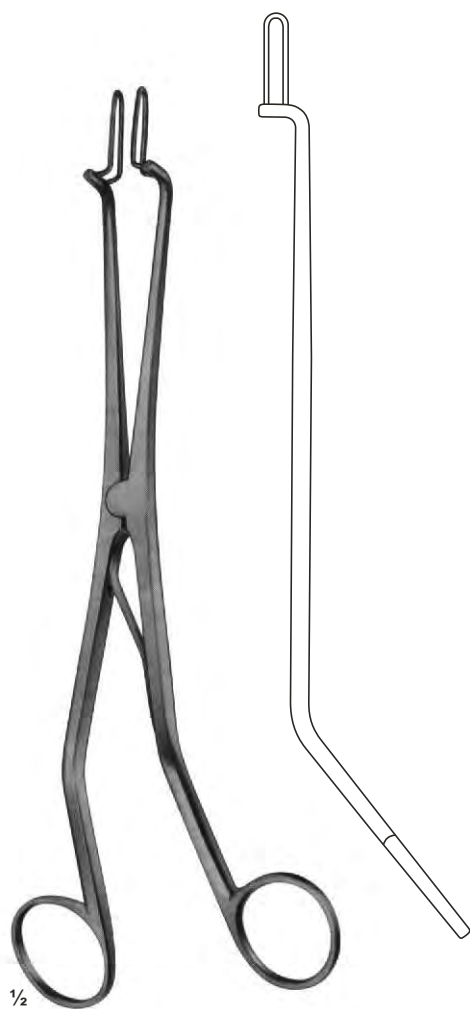

**13-156**  
KOGAN  
Endospecula for cervix  
and urethra, without ratchet  
240 mm



**13-157**  
KOGAN  
Endospecula for cervix  
and urethra, with  
scale-ratchet and fixing screws  
240 mm



5 mm



**14-101**  
MAYO  
biegsam malleable  
330 mm

4 mm



**14-102**  
SIMS  
biegsam malleable  
330 mm

3 mm



**14-103**  
MARTIN  
330 mm

4 mm



**14-104**  
SIMPSON  
malleable  
silver-plated  
290 mm



**14-105**  
BRAUN  
Uterine  
depressor  
270 mm

24 mm



**14-106**  
Cotton  
applicator  
270 mm



**14-107**  
PELMANN  
260 mm



**14-108**  
PELMANN  
260 mm

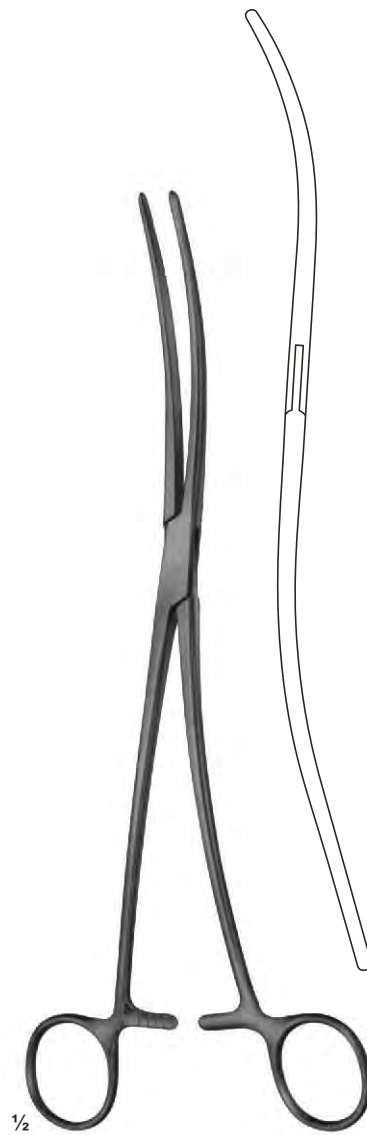

**14-109**  
BOZEMANN  
250 mm

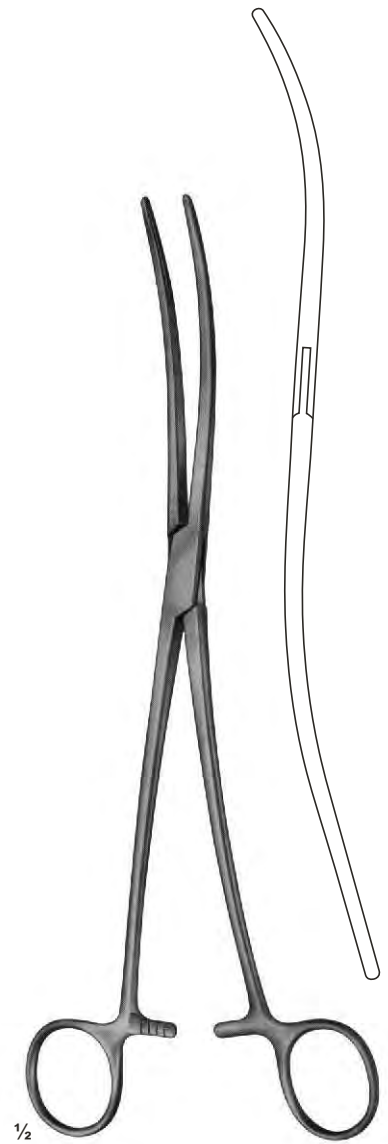

**14-110**  
BOZEMANN  
255 mm

Jaws with longitudinal groove

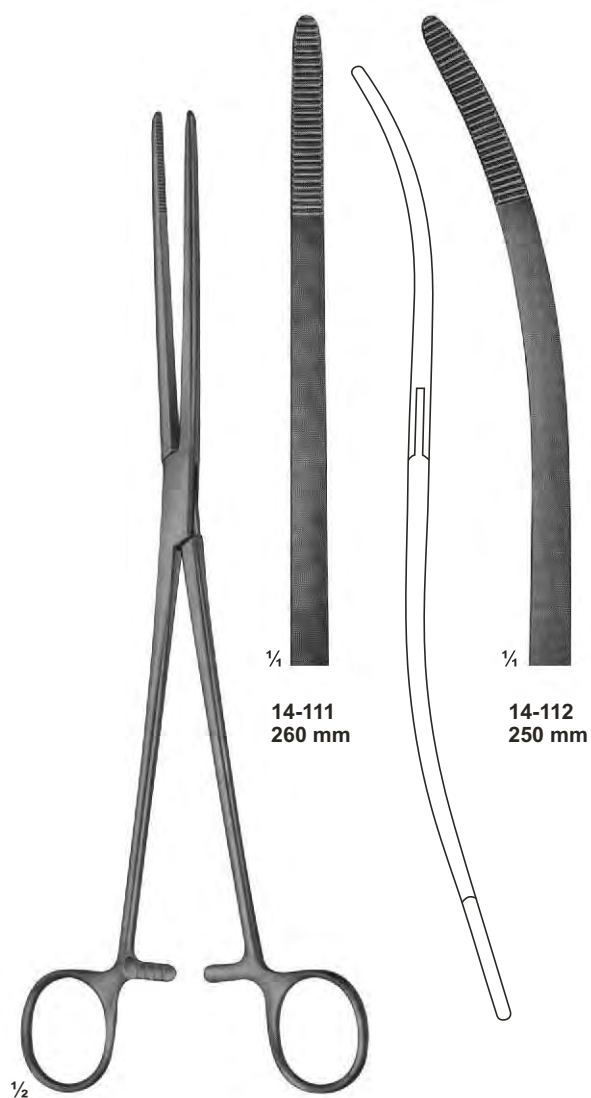

14-111  
260 mm

14-112  
250 mm

14-111 - 112  
BOZEMANN

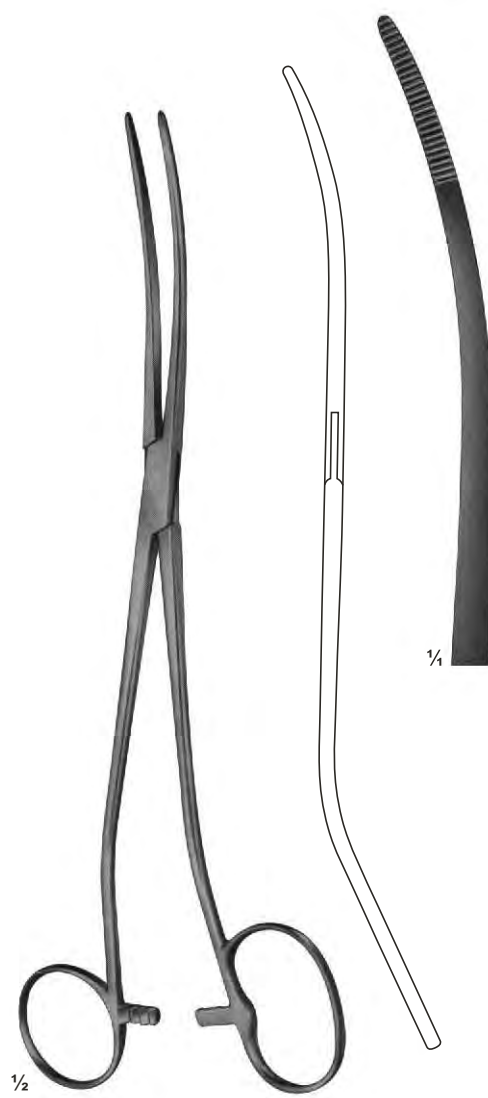

14-113  
BOZEMANN-DOUGLAS  
260 mm



**14-114**  
BRAUN  
slender type  
250 mm



**14-115**  
SCHRODER  
250 mm



**14-116**  
POZZI  
heavy type  
255 mm

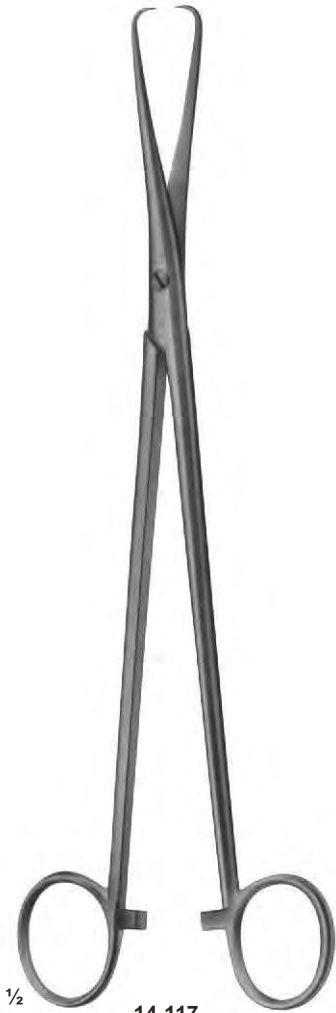

**14-117**  
265 mm

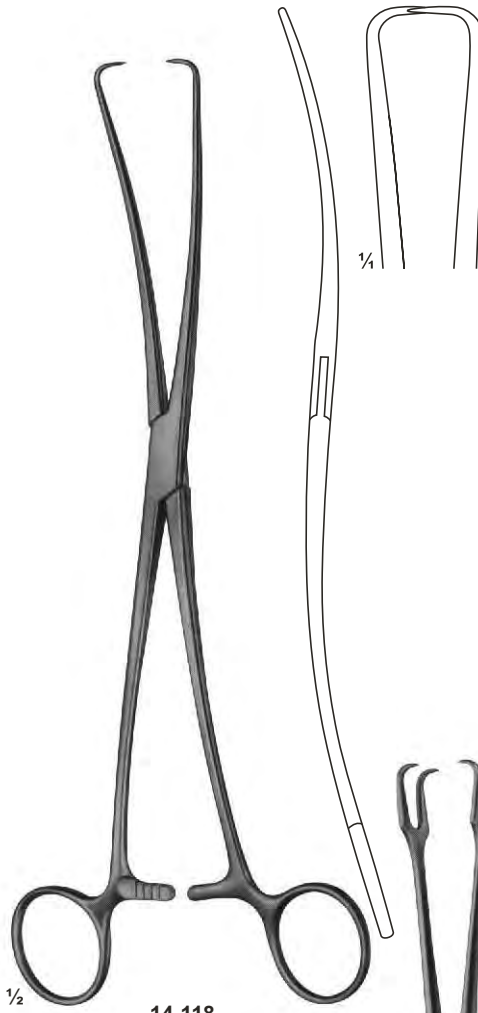
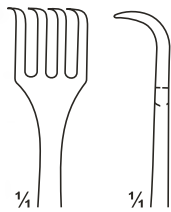

**14-118**  
DUPLAY  
250 mm

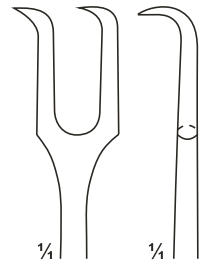

**14-119**  
LAHEY  
155 mm

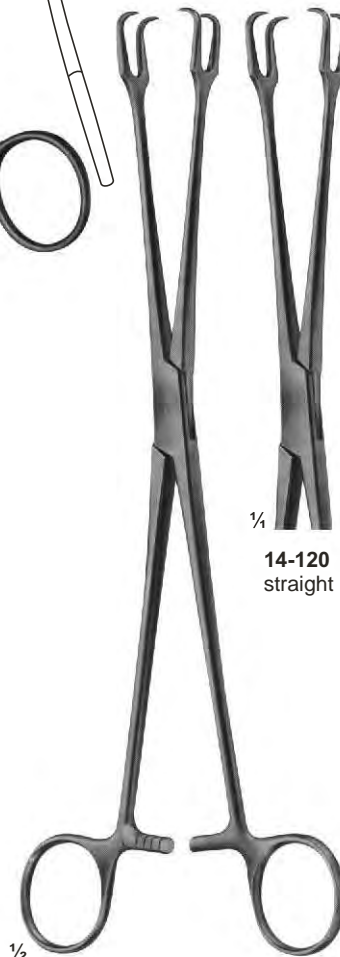

**14-120**  
straight



**14-121**  
curved  
on flat



**14-122**  
curved  
sideways

**14-120 - 122**  
SCHRODER  
250 mm

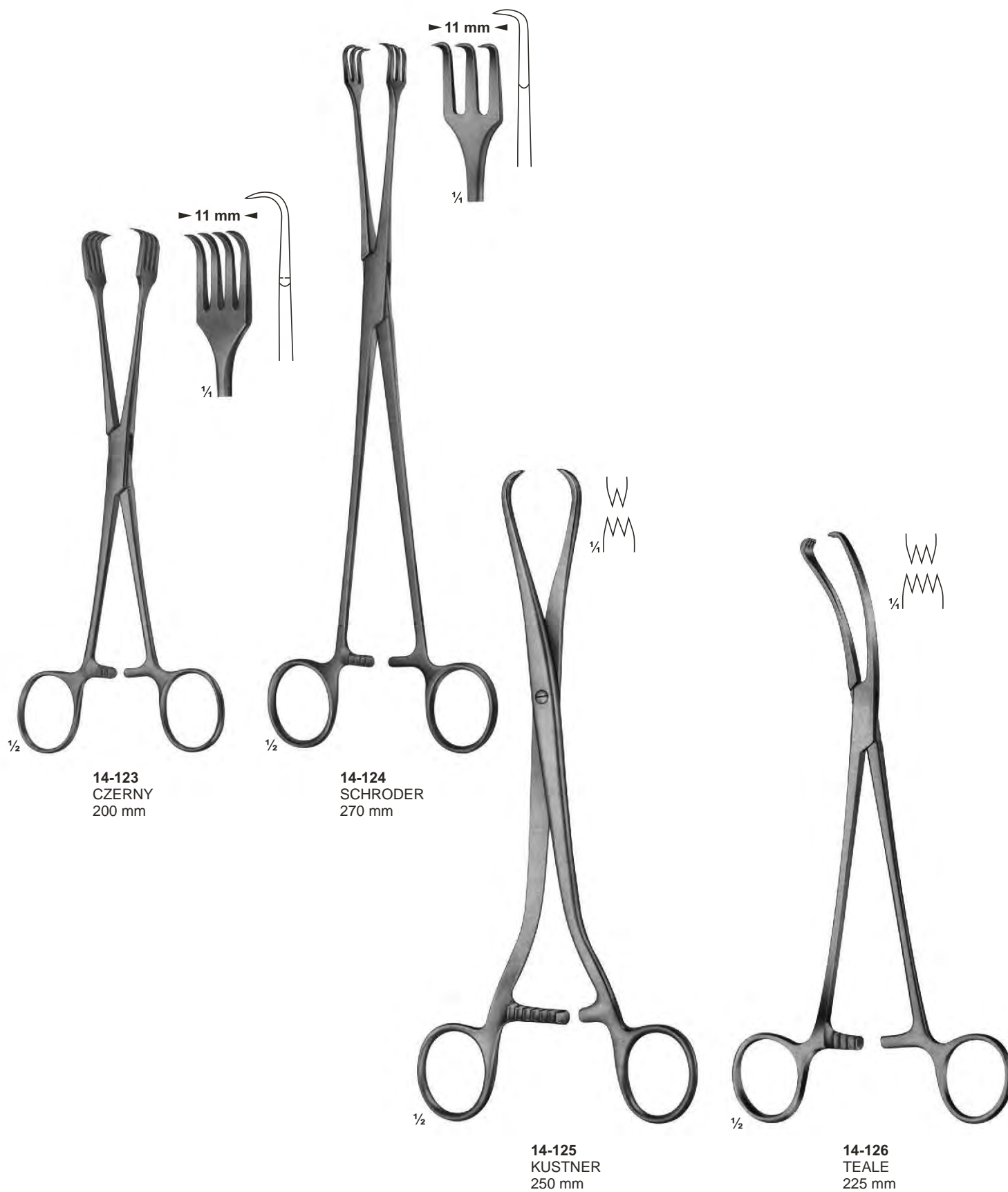



**14-127  
JACOBS  
215 mm**



**14-128  
LITTLEWOOD  
185 mm**



**14-129  
MUSEUX  
200 mm**

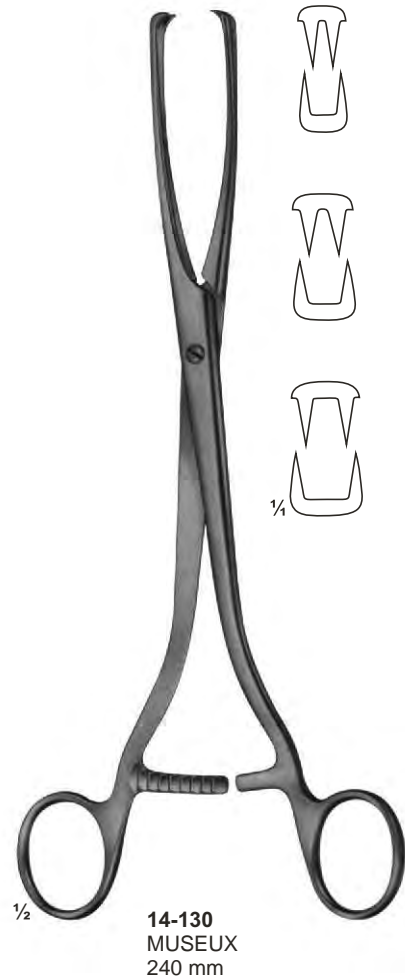

**14-130  
MUSEUX  
240 mm**

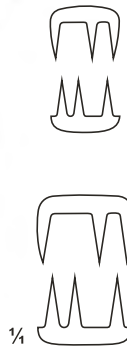

**14-131  
MUSEUX  
Curved sideways  
240 mm**

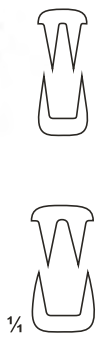
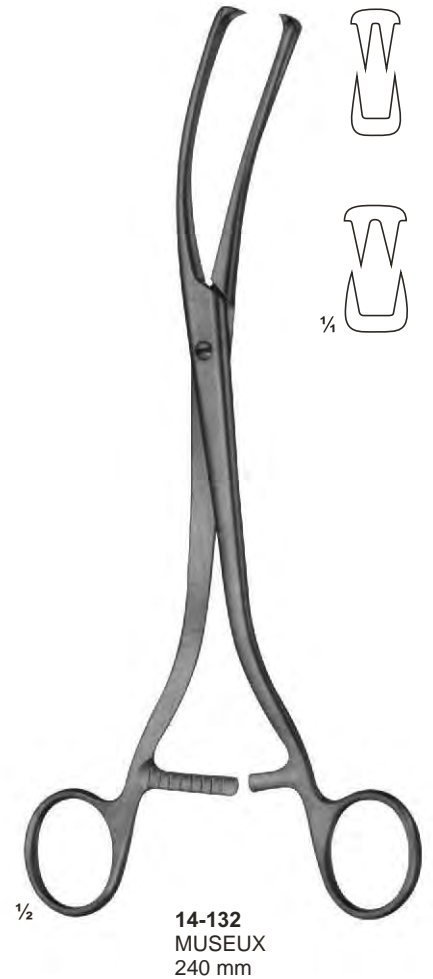

**14-132  
MUSEUX  
240 mm**

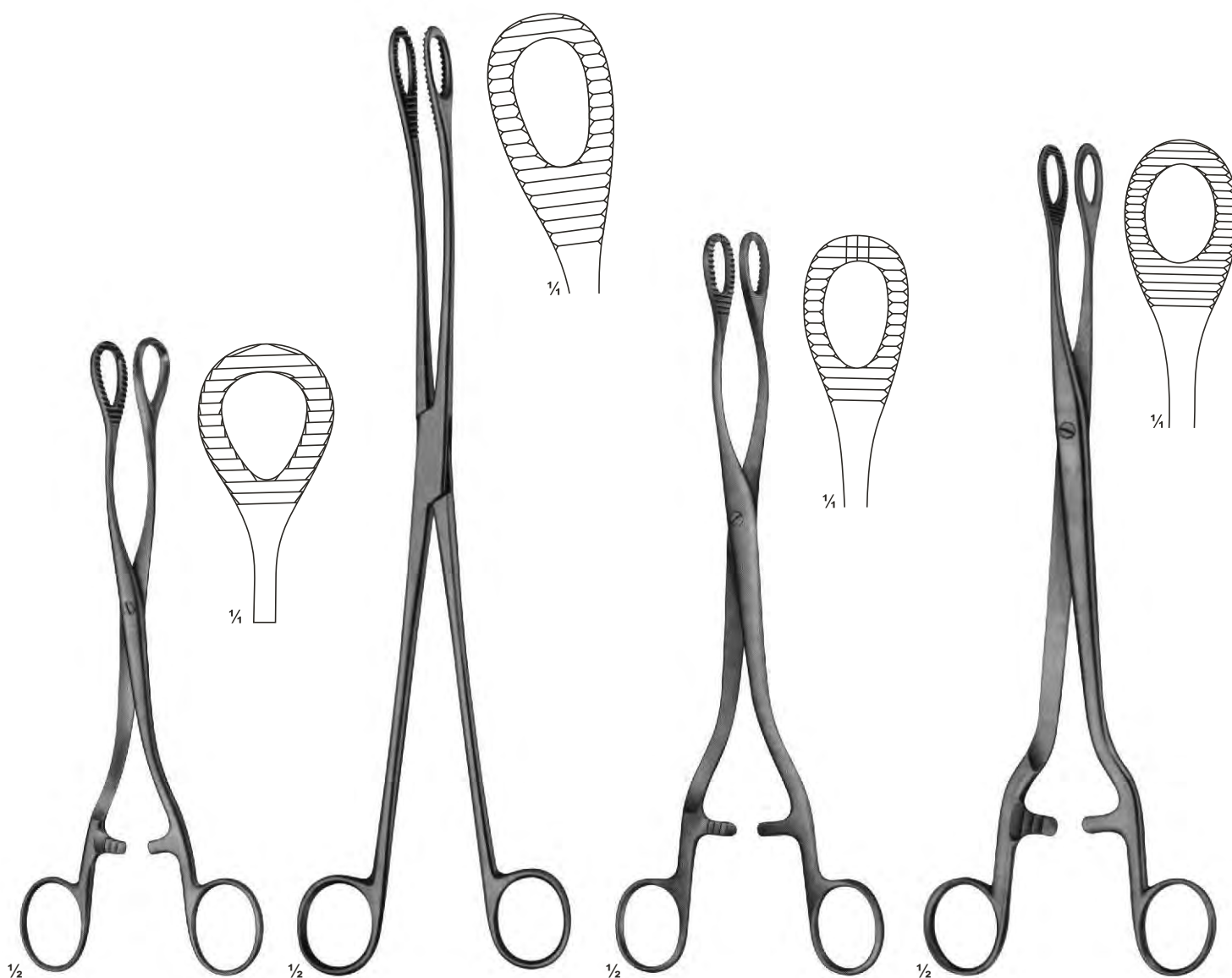

**14-133**  
HEYWOOD-SMITH  
200 mm

**14-134**  
KELLY  
320 mm

**14-135**  
HEYWOOD-SMITH  
250 mm

**14-136**  
NOTO  
280 mm



14-138

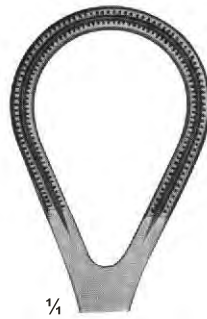

14-139



14-137  
DOYEN  
185 mm



14-138 - 139  
250 mm 270 mm



14-140  
BUMM  
280 mm

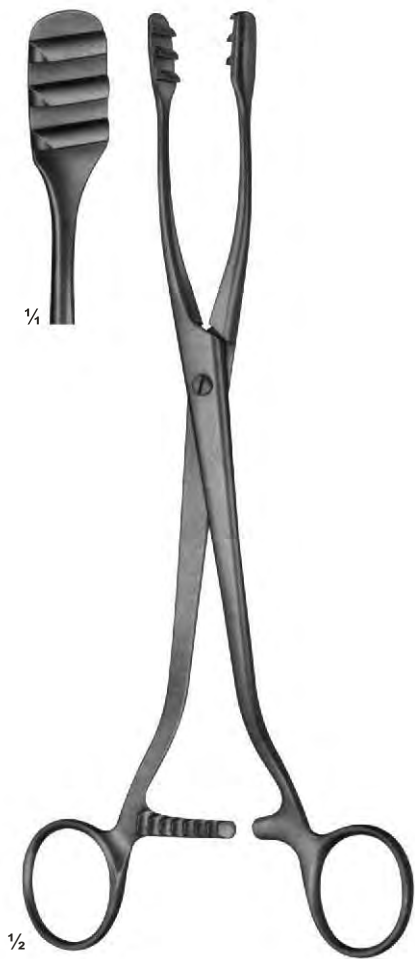

**14-141**  
COLLIN  
250 mm



**14-142**  
COLLIN  
285 mm



**14-143**  
DARTIGUES  
255 mm



**14-144**  
SOMER  
235 mm



**14-145**  
STRASSMANN  
260 mm



With movable jaws



**14-146**  
COLLIN  
265 mm

With movable jaws



**14-147**  
260 mm



**14-148**  
SEGOND  
Myomatome  
270 mm



**14-149**  
DOYEN  
Myoma screw  
150 mm



**14-150**  
DOYEN  
Myoma screw  
190 mm

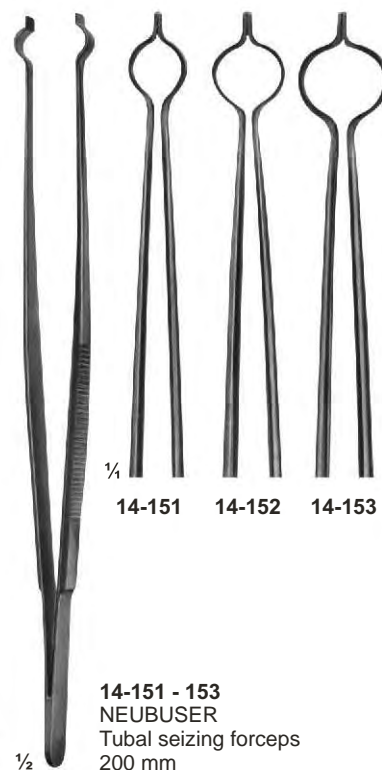

**14-151 - 153**  
NEUBUSER  
Tubal seizing forceps  
200 mm

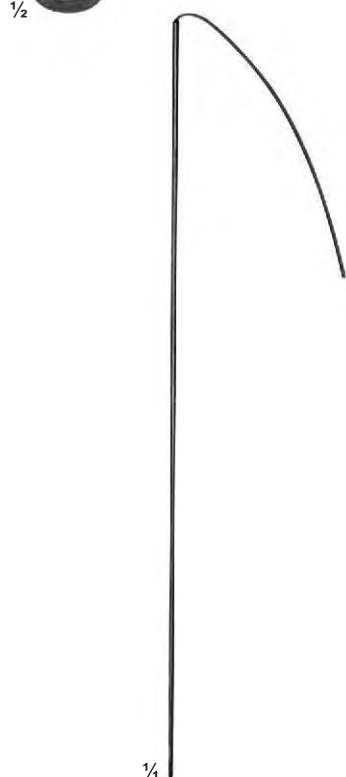

**14-154**  
Splint guide  
with thread



**14-155**  
Splint guide with  
round handle  
180 mm



**14-156**  
Angled glass rods  
Set . 3 pieces



**14-157**  
Silicon operating pad  
pre-cut



**14-158**  
Polyethylen splint material  
soft-sterile  
0.45 mm



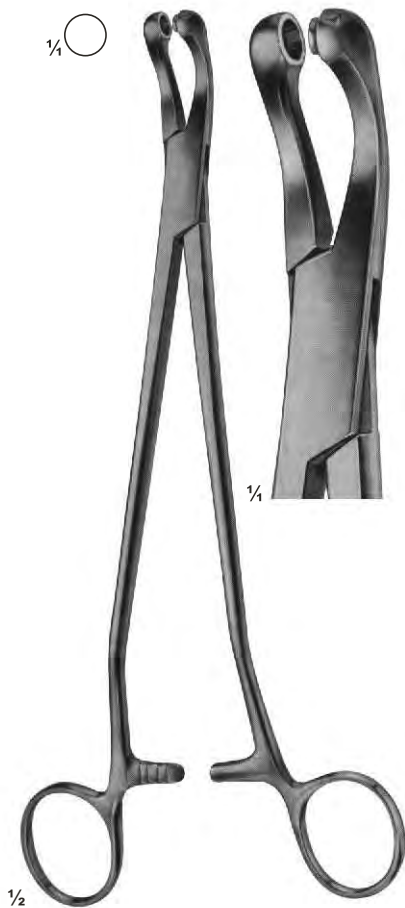

**15-105**  
THOMS-GAYLOR  
240 mm



**15-106**  
SCHUBERT  
260 mm



**15-107**  
FAURE  
210 mm

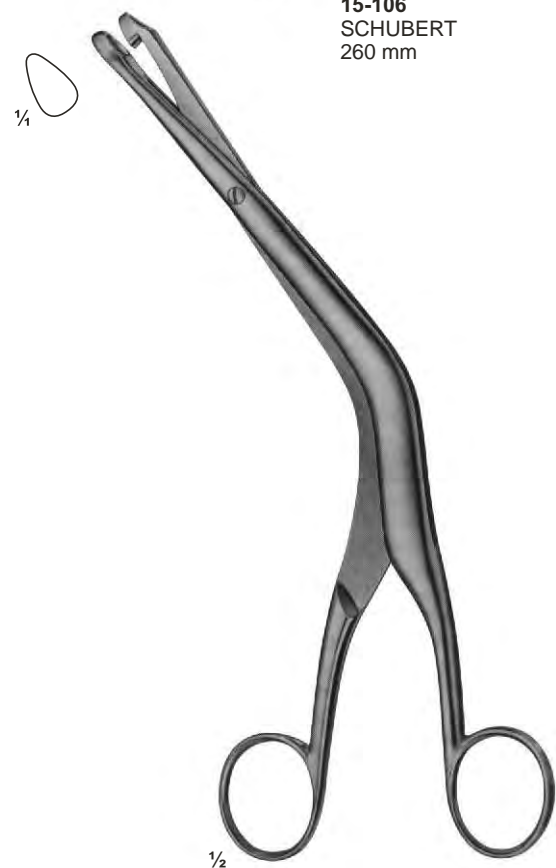

**15-108**  
FAURE  
240 mm

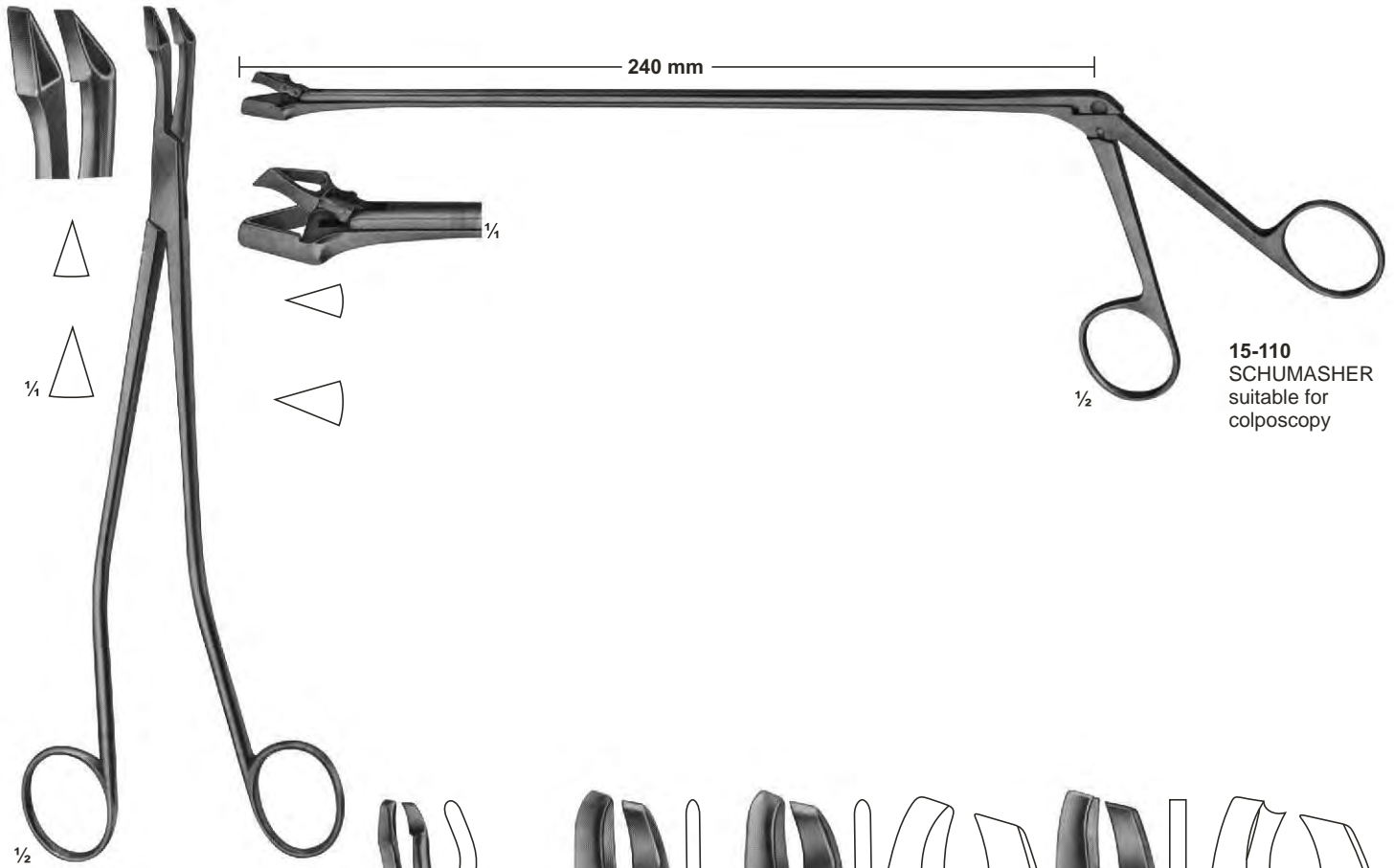

**15-110**  
SCHUMASHER  
suitable for  
colposcopy

**15-109**  
SCHUMASHER  
240mm

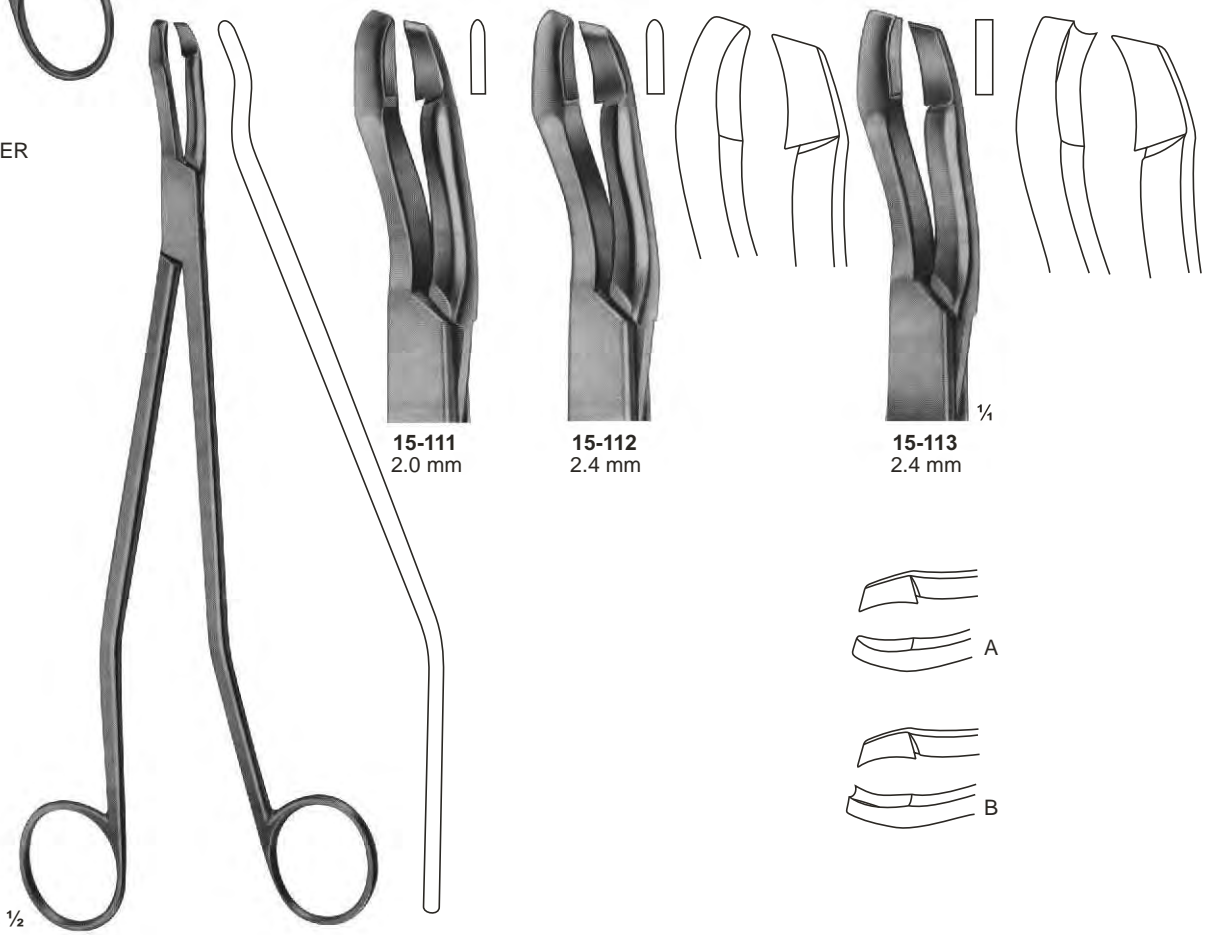

**15-111 - 113**  
SEIDL DBP  
Biopsy forceps, bayonet shaped  
for portio, vagina and vulva  
240mm

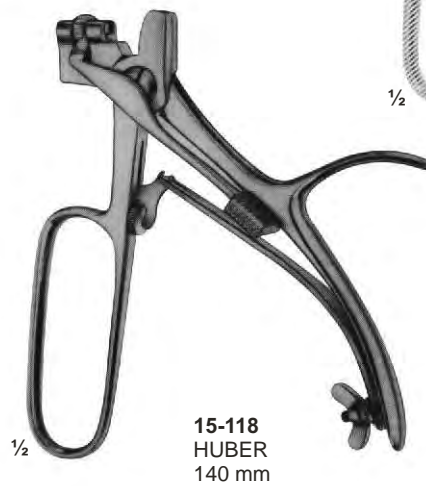
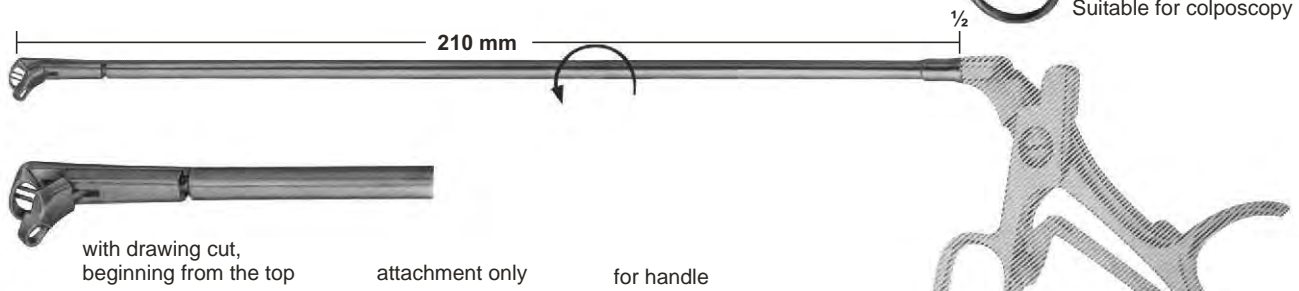
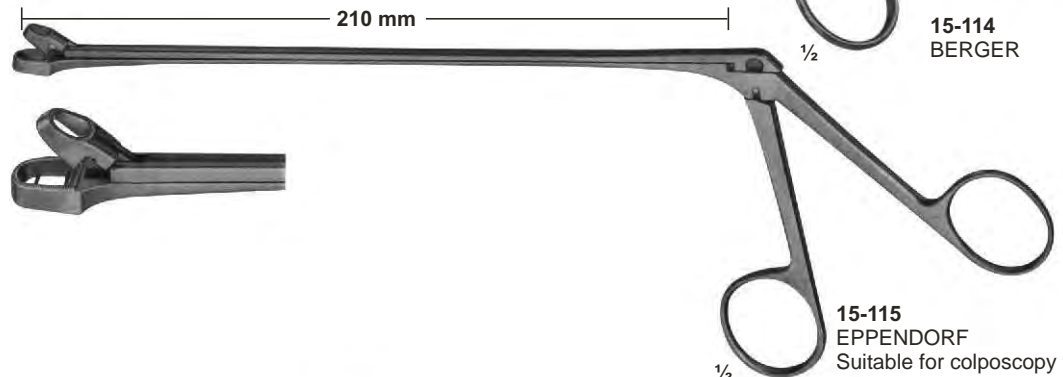
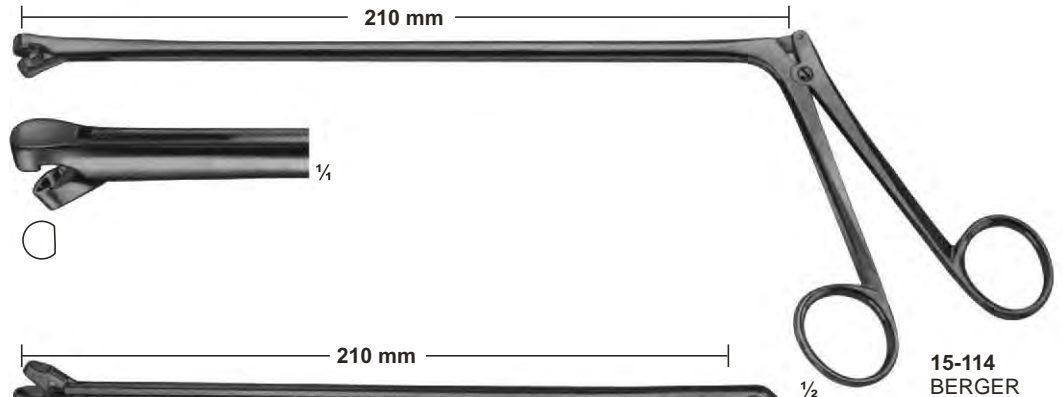

**15-121 KRAUSE** ( Biopsy tip )



**15-122 SCHEINMANN** ( Biopsy tip )



**15-123 SCHEINMANN** ( Biopsy tip )  
with drawing cut

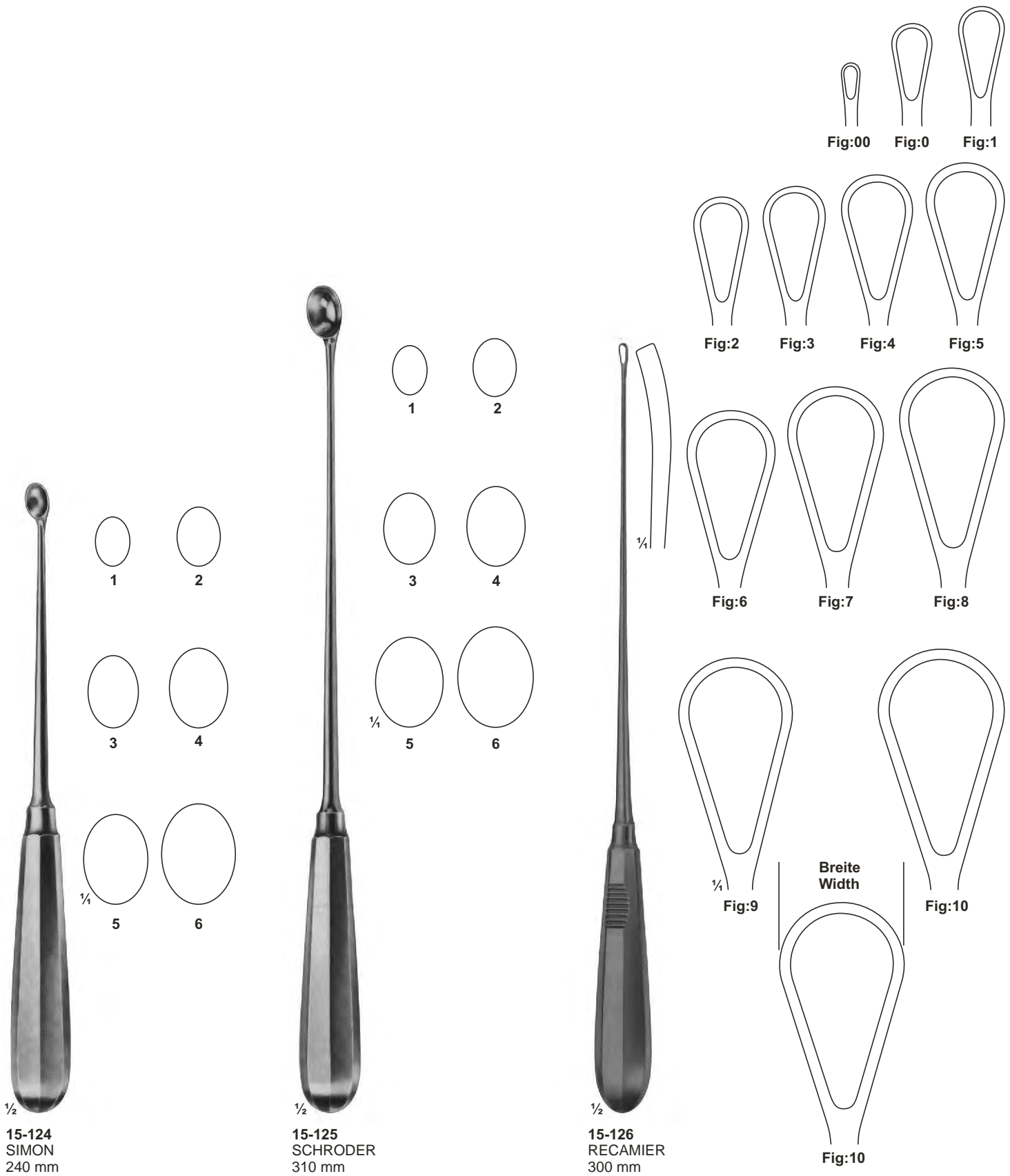

1/2  
**15-124**  
SIMON  
240 mm

1/2  
**15-125**  
SCHRODER  
310 mm

1/2  
**15-126**  
RECAMIER  
300 mm

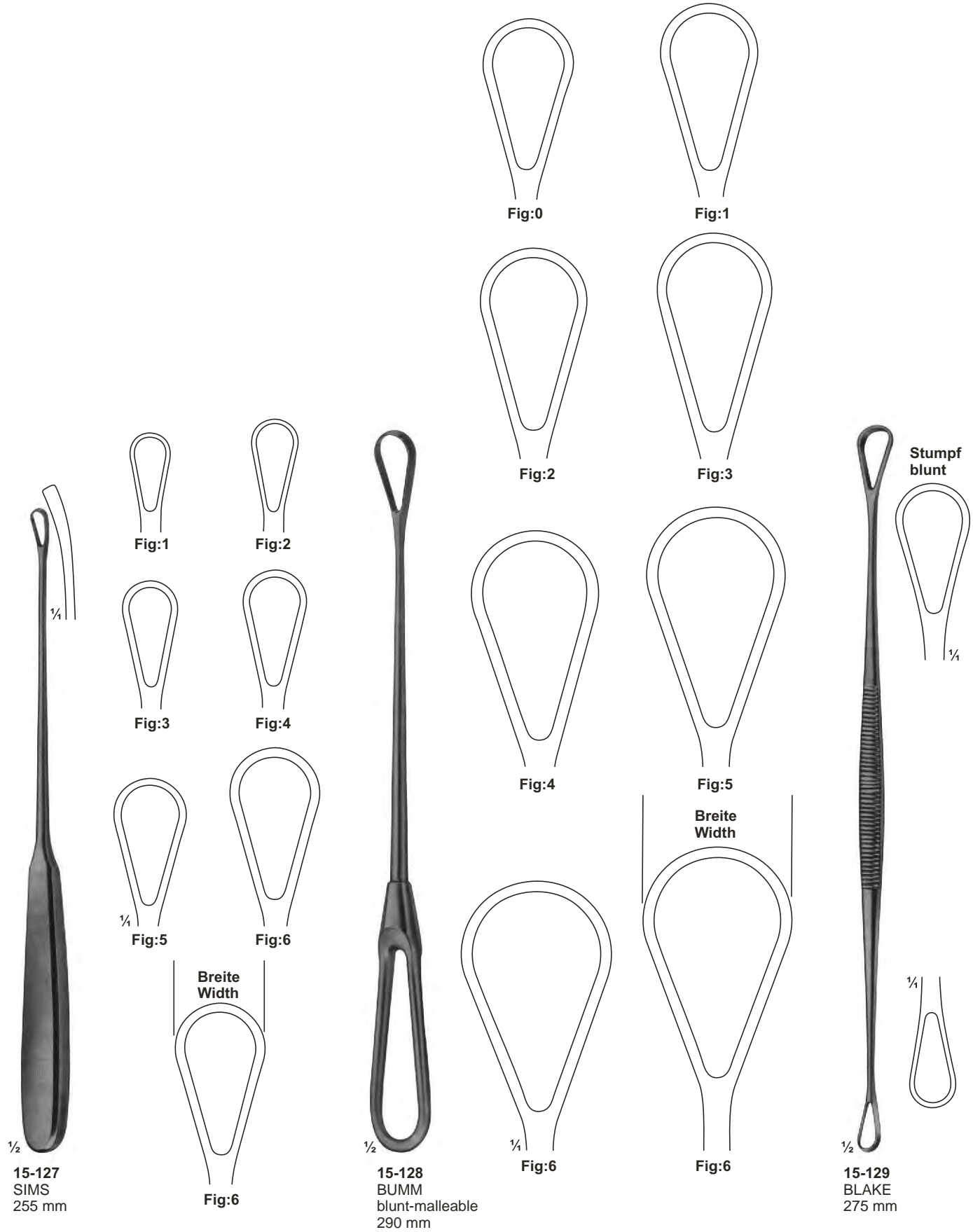

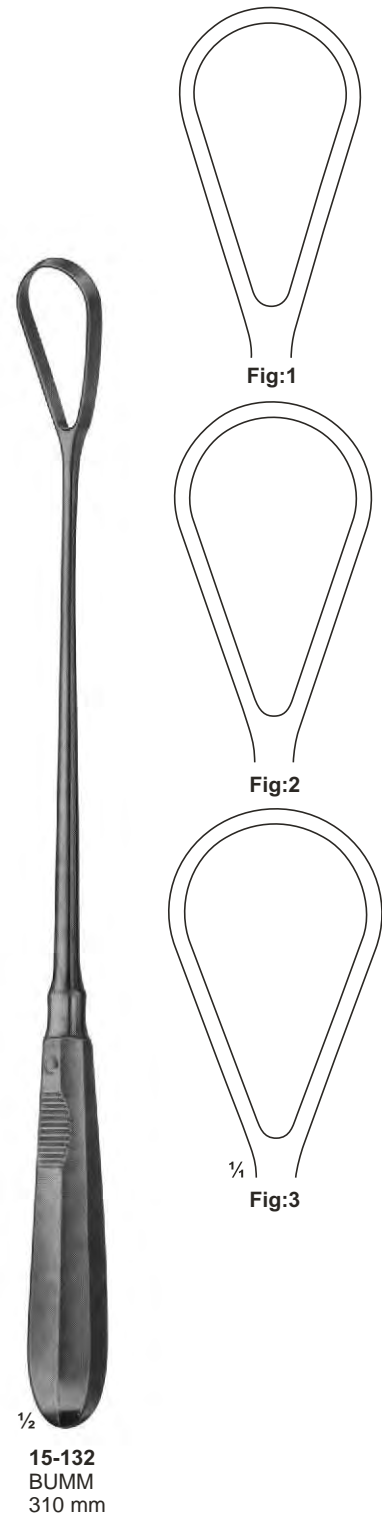
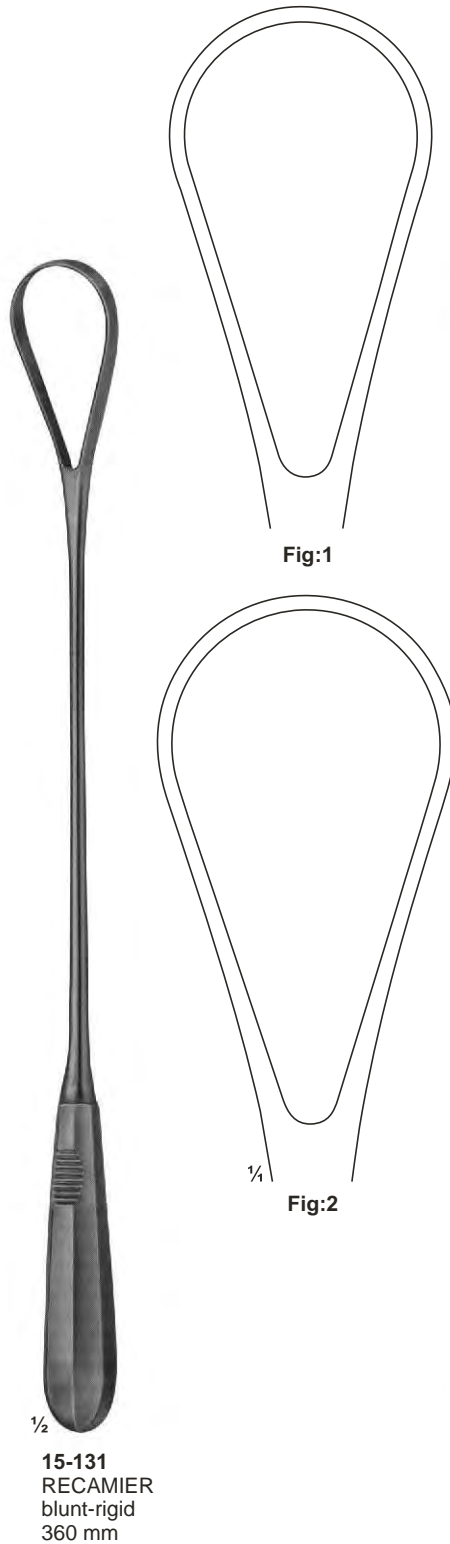



**15-133 - 138**

Suction currettes, stainless steel, fitting hose connection.

Working tips are smoothly rounded of, therefore no danger of perforation.



( suitable for suction biopsy )

**15-133:** diam 4 mm

**15-134:** diam 6 mm

**15-135:** diam 8 mm

**15-136:** diam 10 mm

**15-137:** diam 12 mm

**15-138:** diam 14 mm

**15-139**

Hose connection inside diam. 11 mm curved stainless steel.



**15-140**

The new connection between suction currette and hose connection, Guarantees quick changing and free turning of the suction currettes on the hose connection.

**15-141**

Transparent suction hose 1.8 mm long, inside diam 11 mm, outside diam 16.5 mm can be sterilized in an autoclave at 1 bar overpressure ( 120 C )



**15-142**

Strainer for tissues, plastic, for single use only, to be used for histopathological examination.



15-143 diam 8 mm  
15-144 diam 10 mm  
BOZEMANN-FRITSCH  
Uterine Flushing Tube  
350 mm

1/2



15-145  
SCHULZE  
Salpingograph, for utero-salpingography  
in wooden case, consisting of:  
Manometer, Connection, Uterine canulla  
with tap, Cone S.M.L.,  
Record Syringe 10 cc, Luer lock mount.



15-146  
SCHULZE  
Salpingograph, equipment  
without manometer.



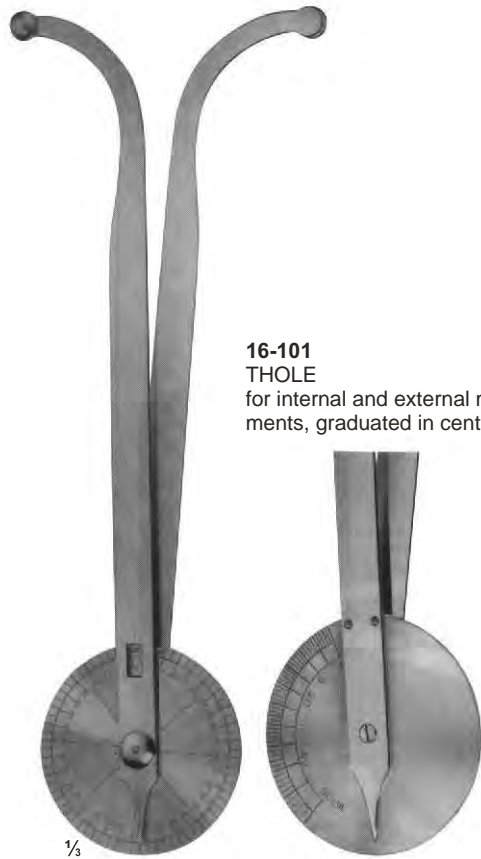

**16-101**  
**THOLE**  
for internal and external measurements, graduated in centimeters



**16-102**  
**DE LEE**  
graduated in centimeters and inches

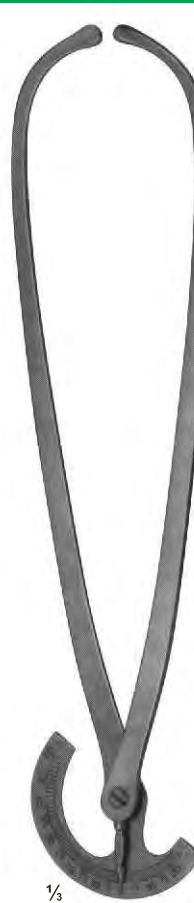

**16-103**  
**COLLIN**  
graduated in centimeters



**16-104**  
**MARTIN**  
graduated in centimeters



**16-105**  
**COLLIN**  
graduated in centimeters

The additional straight arm can be replaced. The pelvimeter with straight arm is used for localisation of the portio vaginalis uteri and of vaginal metastasis.



**16-106**  
**BREISKY**  
graduated in centimeters

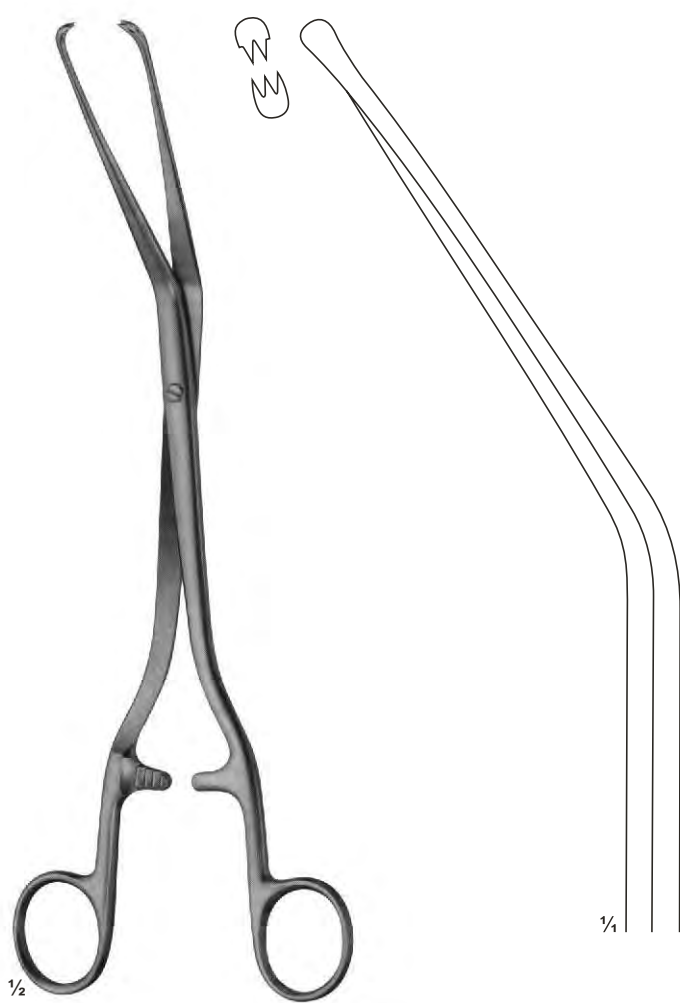

**16-107**  
HERFF  
puncturing forceps  
225 mm



**16-108**  
IOWA  
puncturing forceps  
260 mm



**16-109**  
SCHUMACHER  
Umbilical cord  
scissors  
155 mm



**16-110**  
Umbilical cord  
scissors  
105 mm

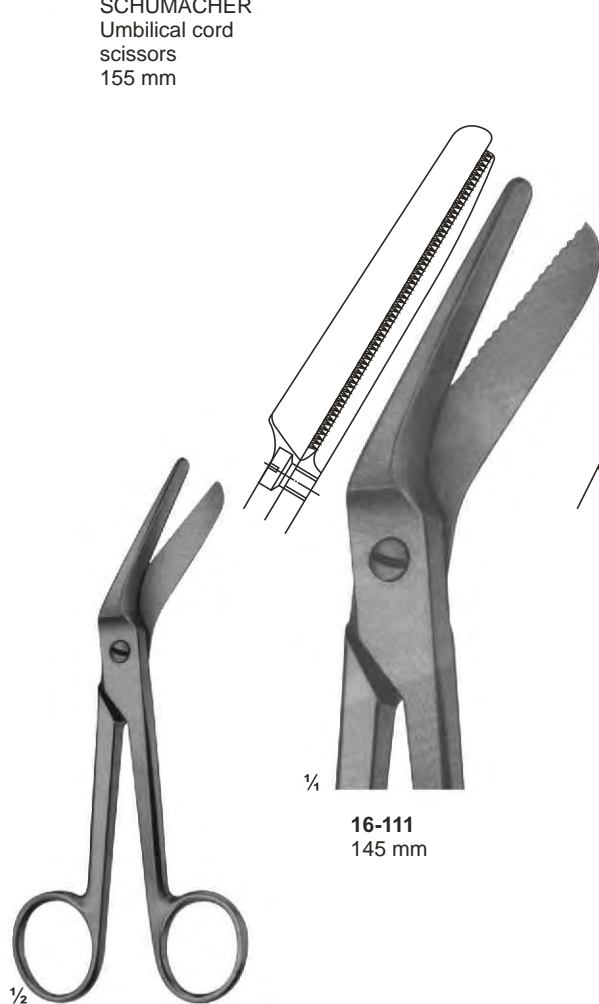

**16-111 - 112**  
BRAUN-STADLER  
Episiotomy Scissors

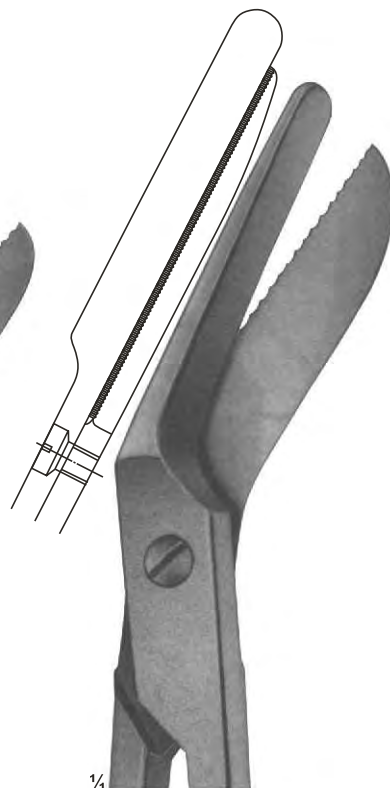

**16-112**  
200 mm

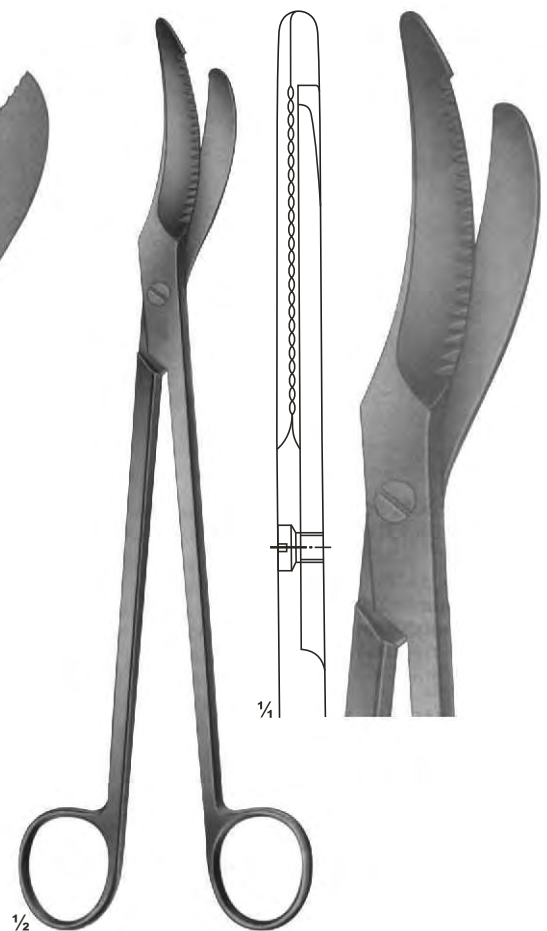

**16-113**  
Episiotomy Scissors  
240 mm



1/3

**16-114**  
355 mm



1/3

**16-115**  
400 mm



1/3

**16-116**  
SIMPSON-BRAUN  
305mm



1/3

**16-117**  
SIMPSON-BRAUN  
305mm



1/3

**16-118**  
SIMPSON  
235mm

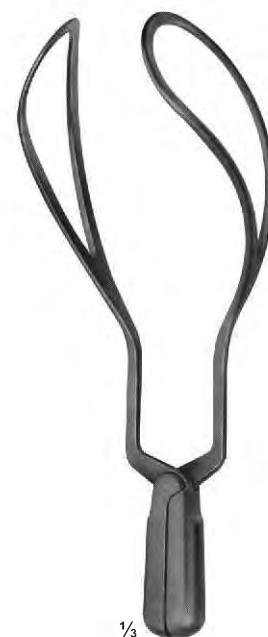

1/3

**16-119**  
WRIGLEY  
250 mm



**16-120**  
**GREEN-ARMYTAGE**  
 Caesarean section haemostatic  
 forceps, for edges of the transverse  
 incision in the lower segment  
 220 mm



**16-121**  
**WILLETT**  
 Scalpel Flap forceps  
 185 mm

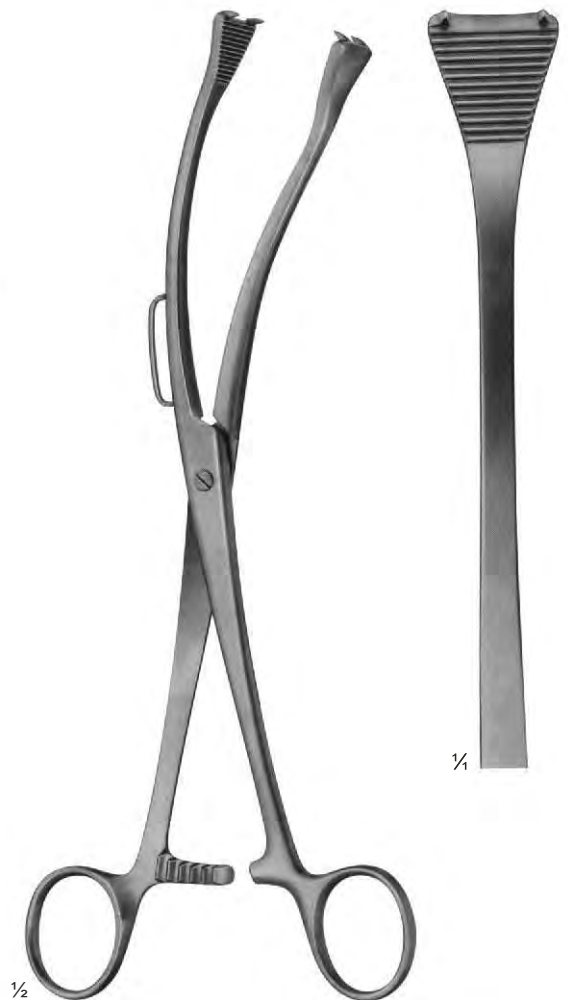

**16-122**  
**GAUSS**  
 Scalpel Flap forceps  
 260 mm

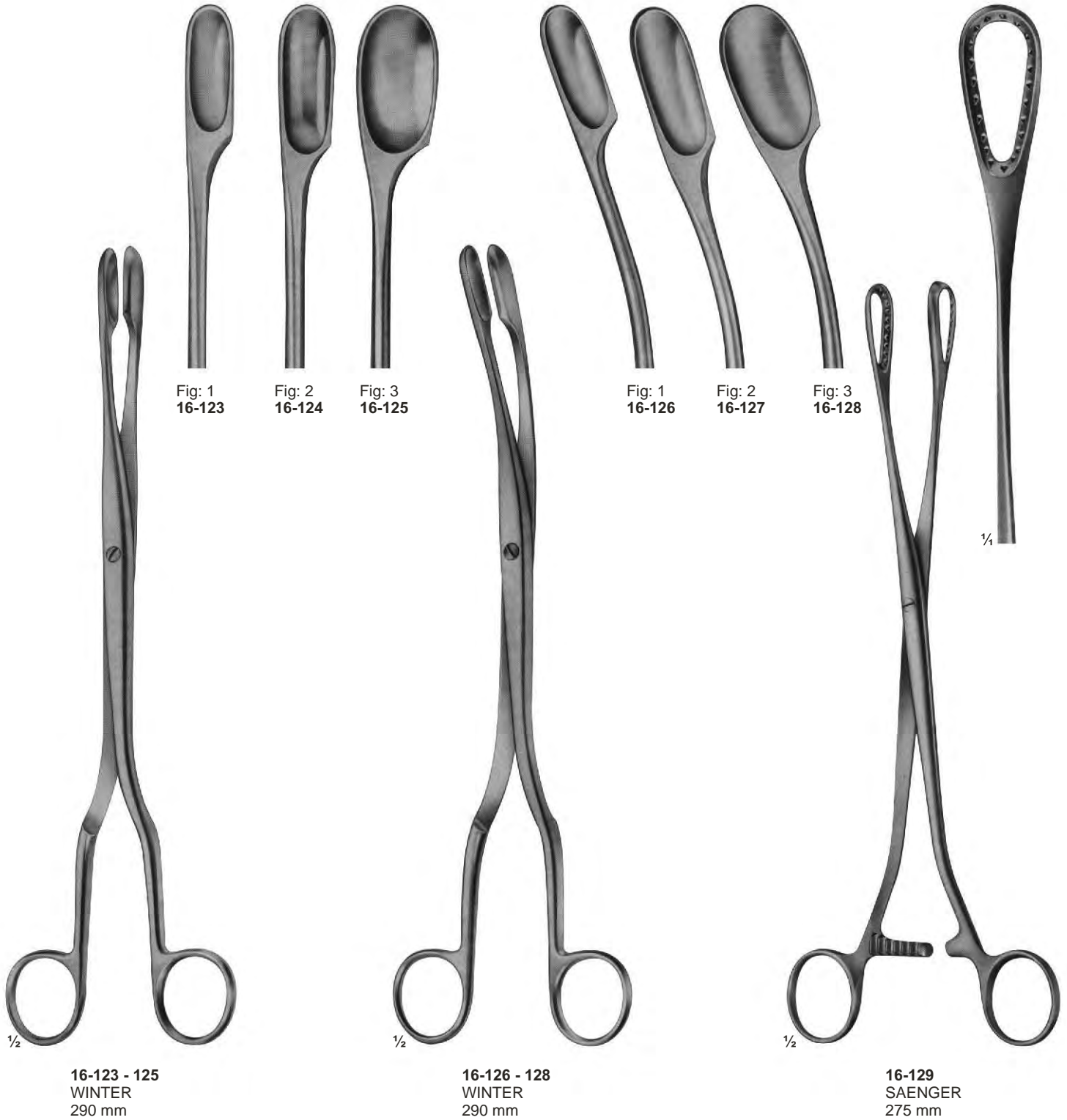

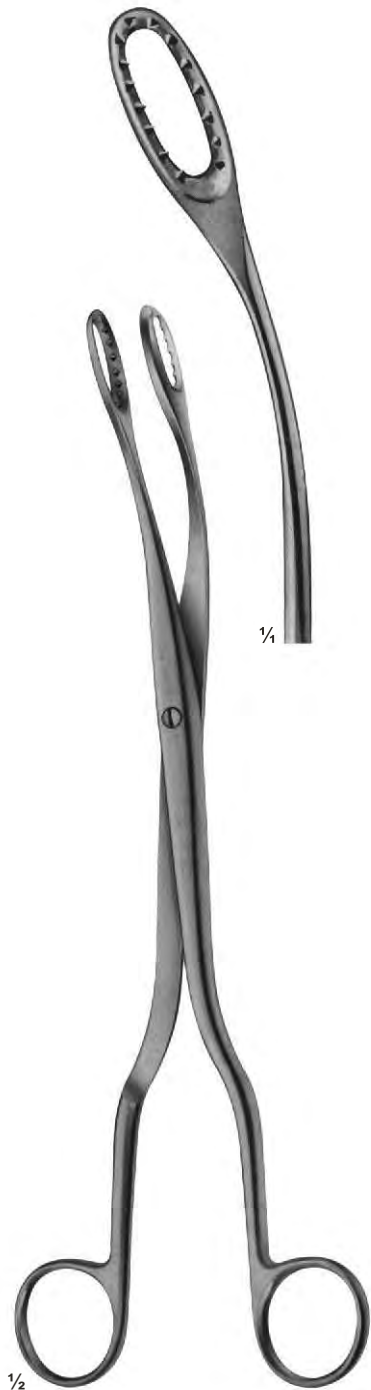

**16-130**  
SAENGER  
285 mm

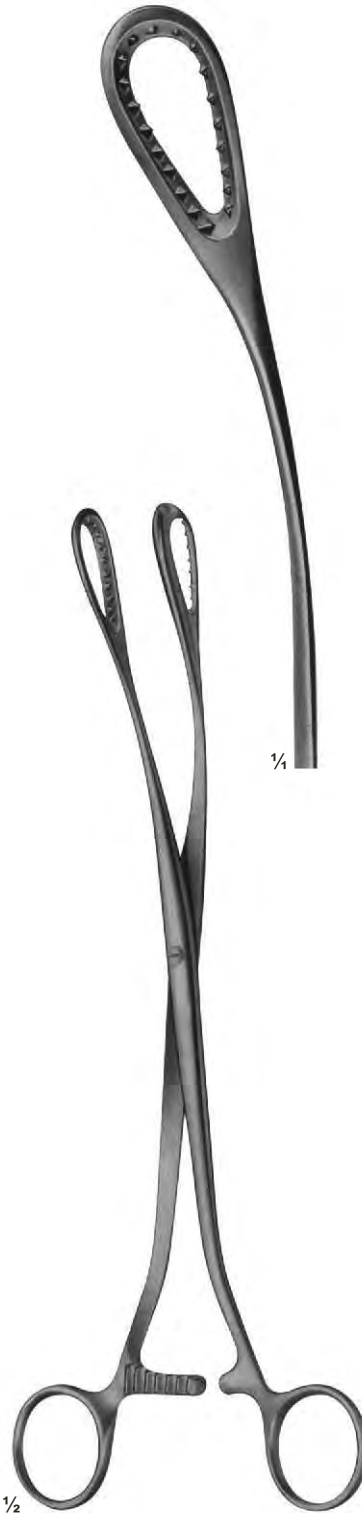

**16-131**  
SAENGER  
285 mm



$\frac{1}{4}$   
**16-132**

$\frac{1}{4}$   
**16-133**

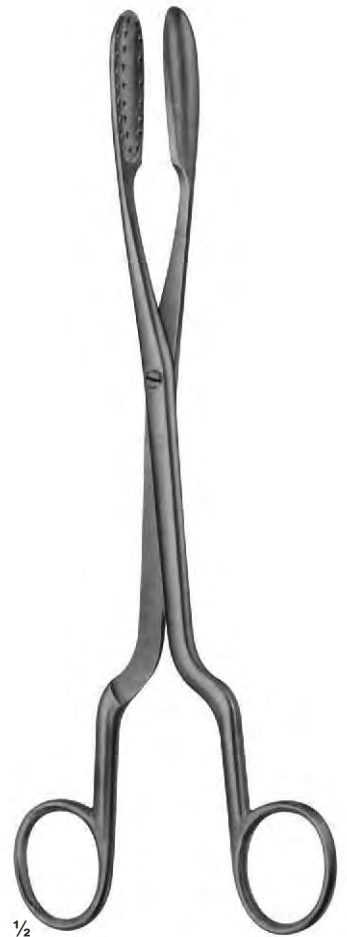

$\frac{1}{2}$   
**16-132 - 133**  
LEWKOWIZ  
245 mm

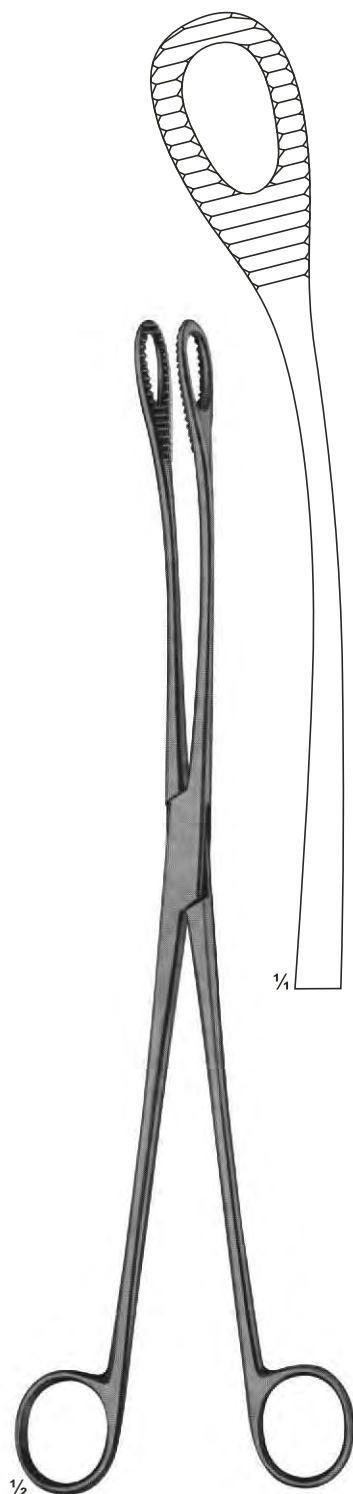

**16-134**  
KELLY  
320mm



**16-135**  
SMELLIE  
Perforator  
270mm



**16-136**  
BRAUN  
Cranioclast  
420mm



1/2

**16-137**  
UECKERMANN-DENKER  
Cryothyrotomy trocar  
with silver cannula  
130mm

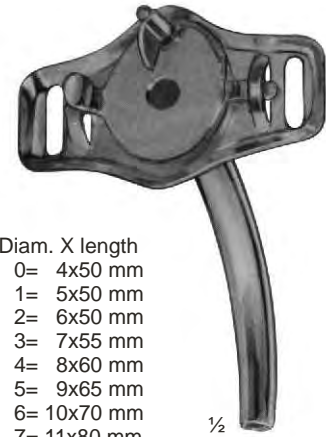

1/2

Diam. X length  
**16-138** Fig. 0= 4x50 mm  
**16-139** Fig. 1= 5x50 mm  
**16-140** Fig. 2= 6x50 mm  
**16-141** Fig. 3= 7x55 mm  
**16-142** Fig. 4= 8x60 mm  
**16-143** Fig. 5= 9x65 mm  
**16-144** Fig. 6= 10x70 mm  
**16-145** Fig. 7= 11x80 mm  
**16-146** Fig. 8= 12x85 mm  
**16-147** Fig. 9= 13x90 mm  
**16-148** Fig. 10=14x90 mm

**16-138 - 148**  
LUER  
German silver



1/2

**16-149 - 158**  
JACKSON  
German Silver

Diam. X length  
**16-149** Fig. 0= 4x50 mm  
**16-150** Fig. 1= 5x58 mm  
**16-151** Fig. 2= 6x58 mm  
**16-152** Fig. 3= 7x70 mm  
**16-153** Fig. 4= 8x78 mm  
**16-154** Fig. 5= 9x84 mm  
**16-155** Fig. 6= 10x84 mm  
**16-156** Fig. 7= 11x86 mm  
**16-157** Fig. 8= 12x88 mm  
**16-158** Fig. 9= 13x90 mm



1/2

Diam. X length  
**16-159** Fig. 1= 5x48 mm  
**16-160** Fig. 2= 6x58 mm  
**16-161** Fig. 3= 7x70 mm  
**16-162** Fig. 4= 8x78 mm  
**16-163** Fig. 5= 9x84 mm  
**16-164** Fig. 6= 10x84 mm  
**16-165** Fig. 7= 11x86 mm  
**16-166** Fig. 8= 12x88 mm  
**16-167** Fig. 9= 13x90 mm  
**16-168** Fig.10= 14x90 mm

**16-159 - 168**  
JACKSON  
German Silver

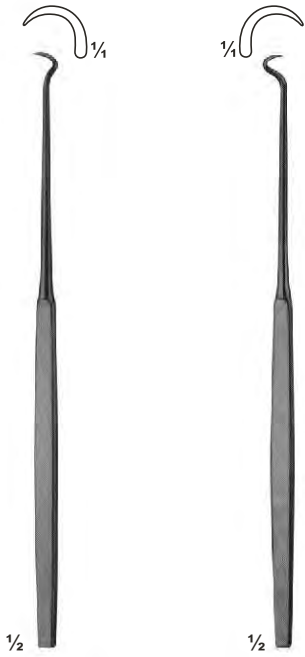

**16-169**  
BOSE  
165 mm



**16-170**  
BOSE  
165 mm

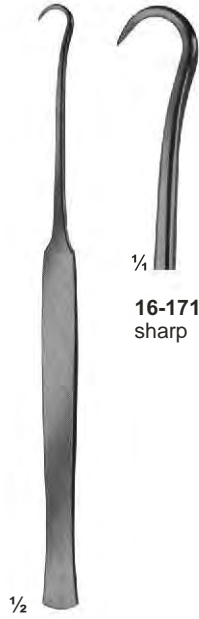

**16-171 - 173**  
180 mm



**16-171**  
sharp



**16-172**  
blunt

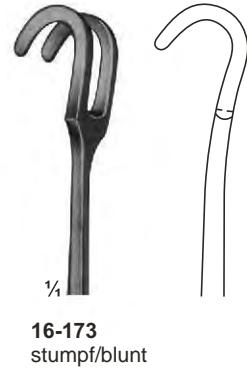

**16-173**  
stumpf/blunt



**16-174**  
FINSEN  
50 mm



**16-175**  
FINSEN  
70 mm



**16-176**  
TROUSSEAU  
120 mm



**16-177**  
LABORDE  
125 mm



**16-178**  
LABORDE  
strong pattern  
135 mm



**16-179**  
Cleaning Brush  
for tracheal tubes  
285 mm

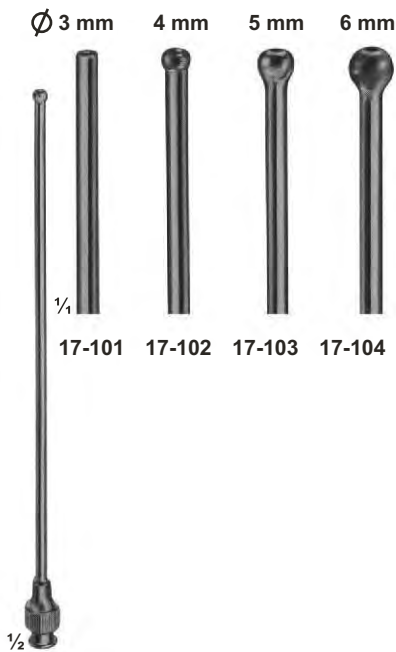

**17-101 - 104**  
**SCHMID**  
 Vessel irrigating cannulae,  
 malleable, silver plated  
 150 mm

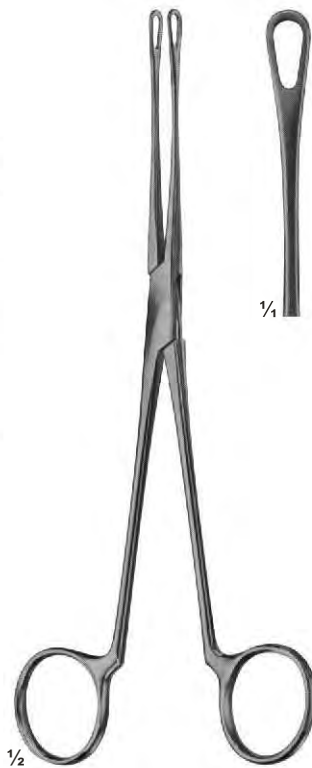

**17-105**  
**BLAKE**  
 Embolus grasping  
 forceps  
 205 mm

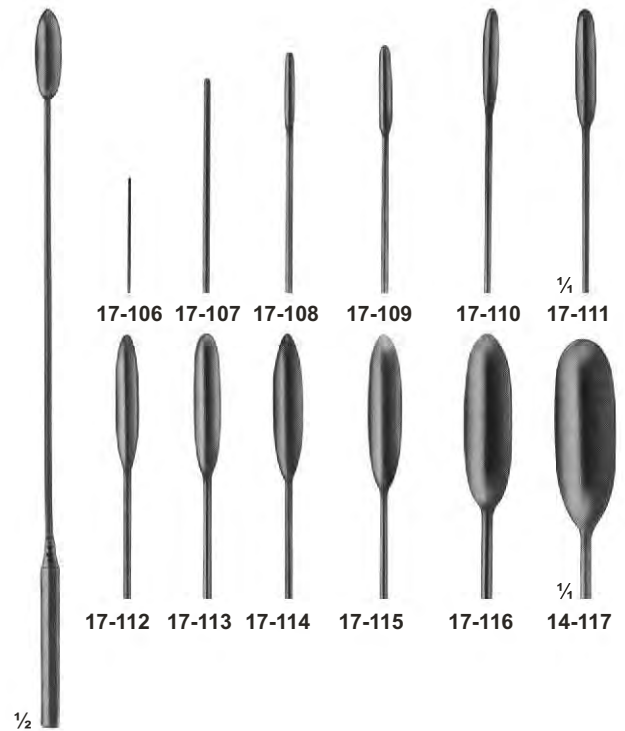

**17-106 - 117**  
**DE BAKEY**  
 Vascular dilators,  
 malleable  
 190 mm

<b>17-106</b> 0,5 mm Ø	<b>17-112</b> 3,5 mm Ø
<b>17-107</b> 1,0 mm Ø	<b>17-113</b> 4,0 mm Ø
<b>17-108</b> 1,5 mm Ø	<b>17-114</b> 4,5 mm Ø
<b>17-109</b> 2,0 mm Ø	<b>17-115</b> 5,0 mm Ø
<b>17-110</b> 2,5 mm Ø	<b>17-116</b> 7,0 mm Ø
<b>17-111</b> 3,0 mm Ø	<b>17-117</b> 9,0 mm Ø

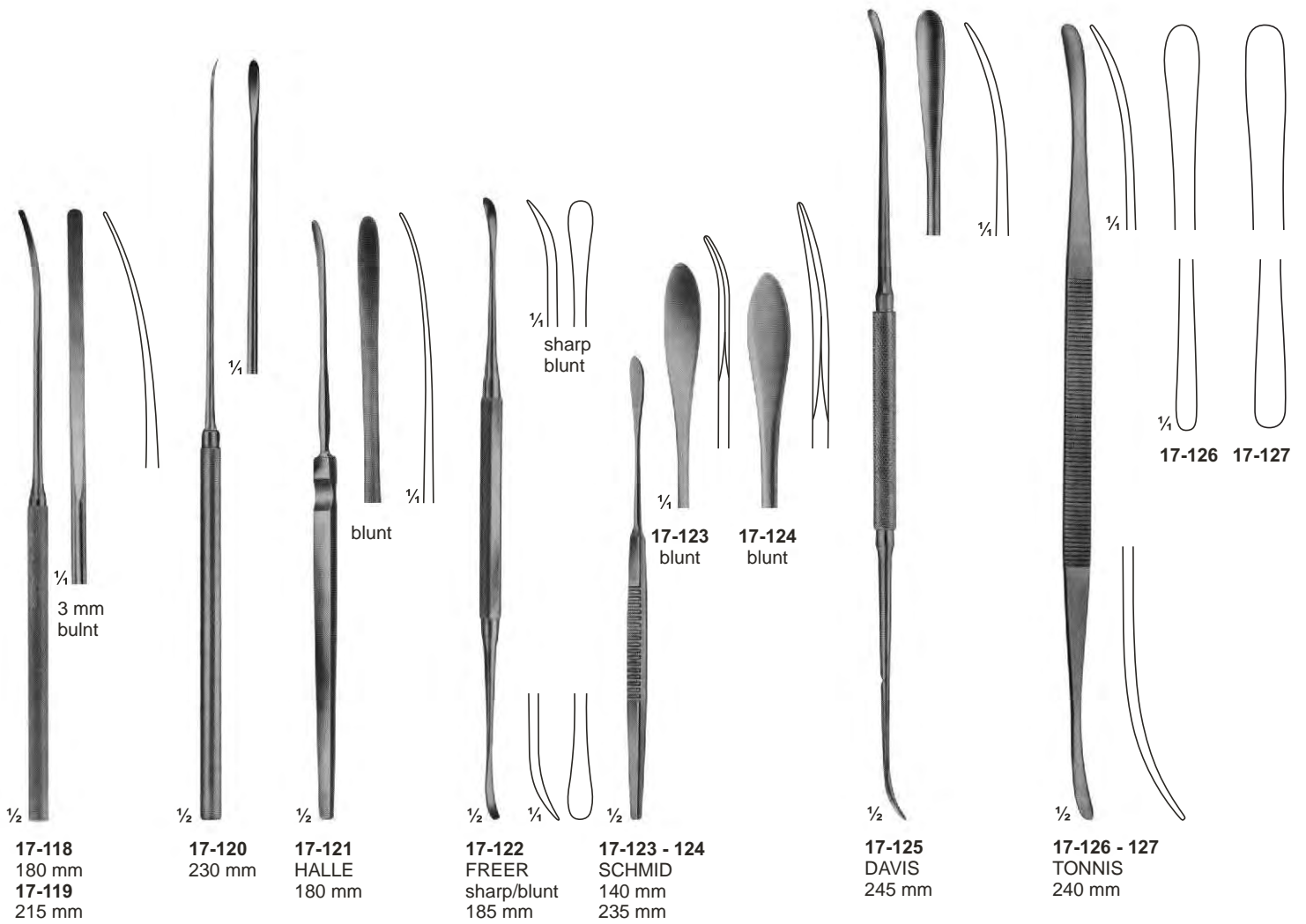

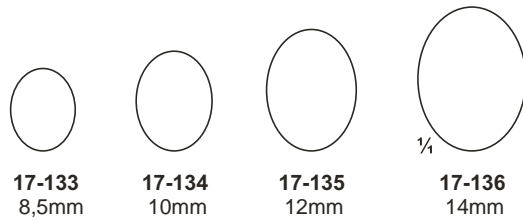
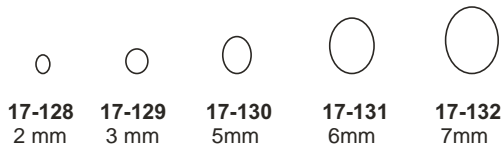

**17-128 - 136**  
Endarterectomy strippers  
550 mm



**17-137**  
Handle for  
110 mm

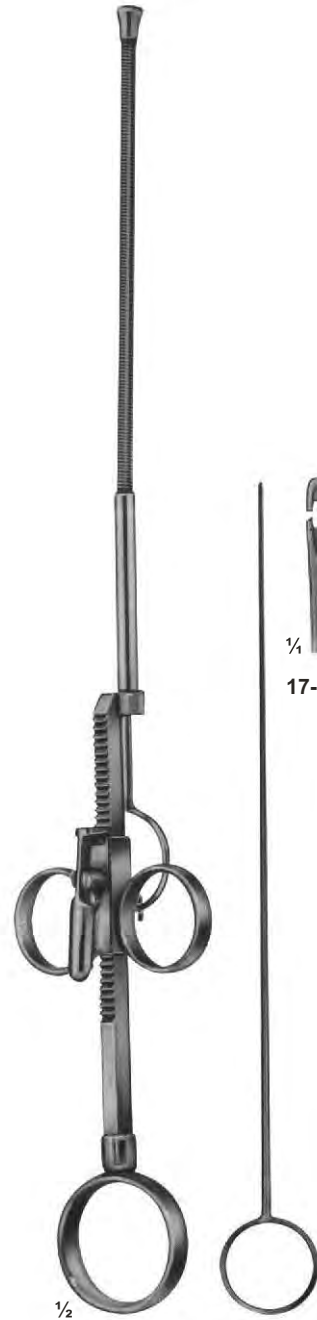

**17-138 - 139**  
RUMEL-BELBONT  
325 mm  
17-138 - 4,0 mm Ø  
17-139 - 6,4 mm Ø



**17-140 17-141**



**17-140 - 141**  
Guide only

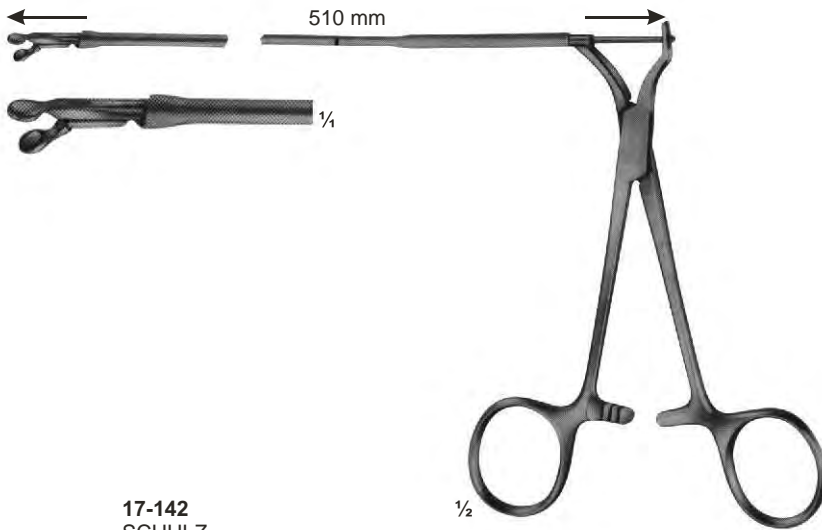

**17-142  
SCHULZ**

Biopotome, mit flexiblem Schaft, 510 mm lang,  
with round jaws 3 mm diam.

Biopsy forceps, for biopsy from the right atrium  
through cava juglaris, prior to heart implantations.

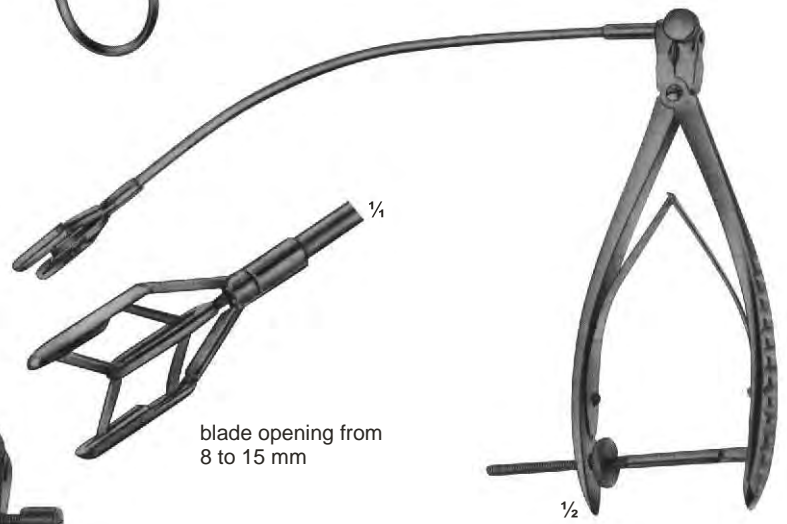

**17-144  
COOLEY**  
Dilator for  
mitral valve  
for children

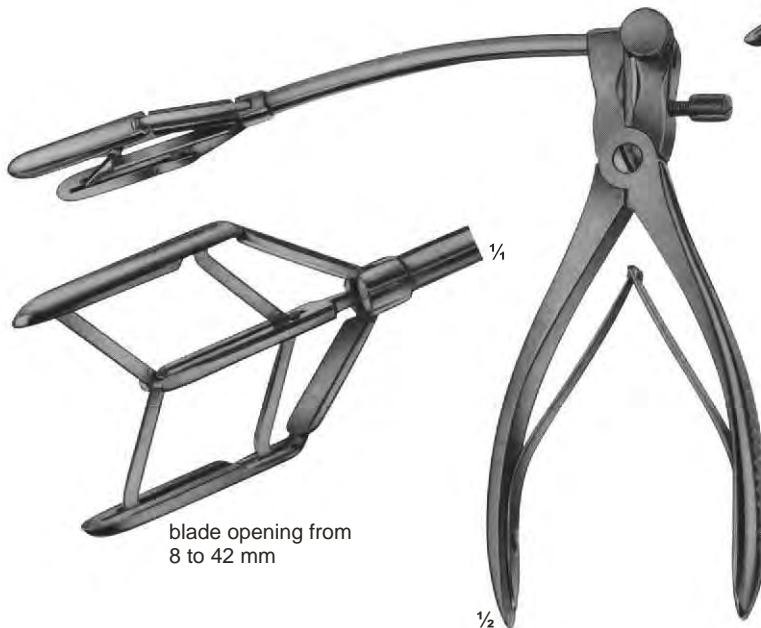

**17-143  
TUBBS**  
Dilator for  
mitral valve

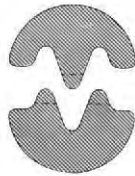
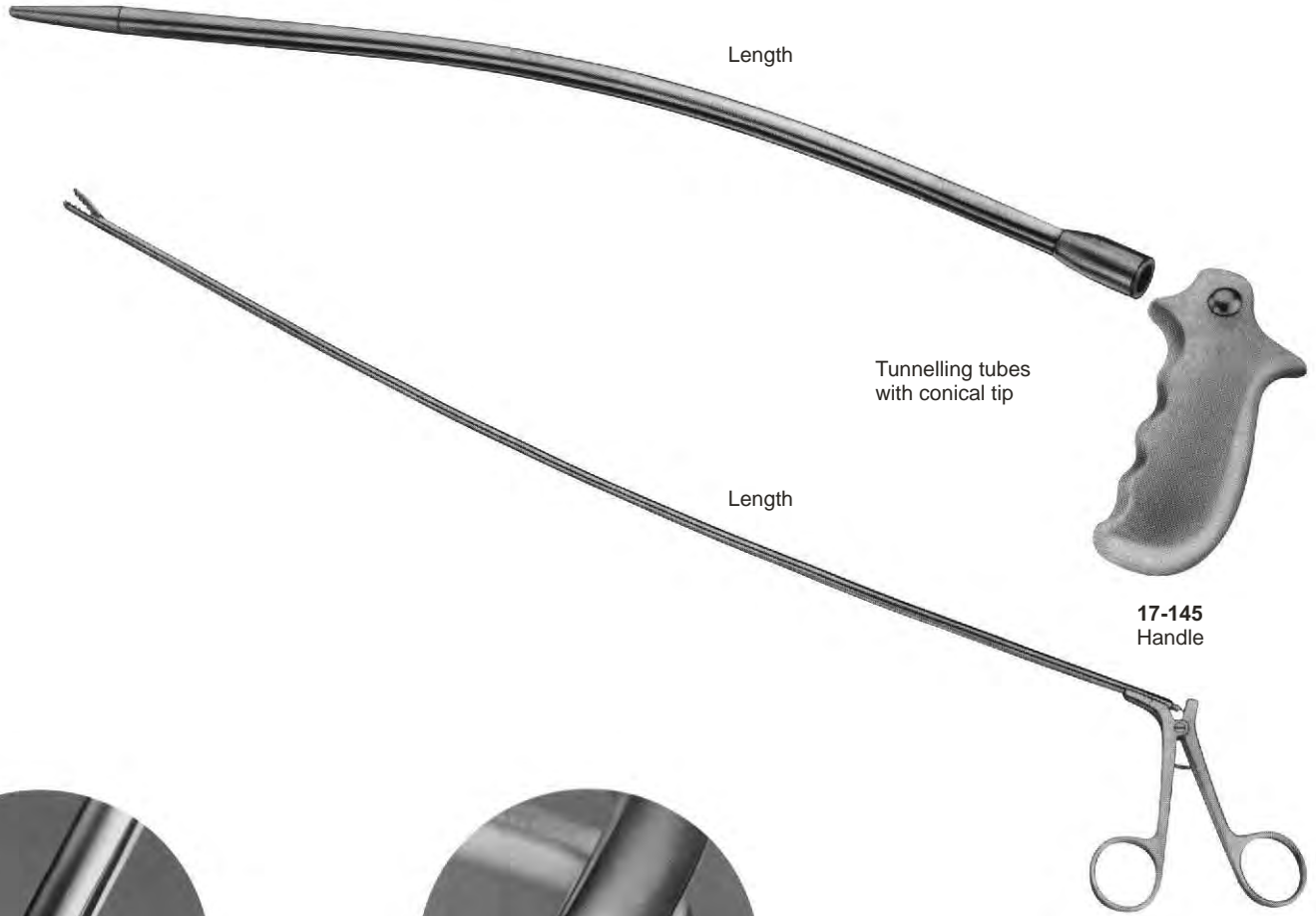

### DE BAKEY

17-147  
1 : 2 rows of teeth

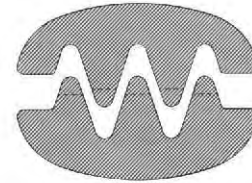

### DE BAKEY

17-148  
2 : 3 rows of teeth

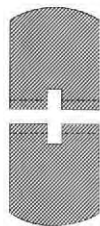

### COOLEY

17-149  
2 : 2 rows of teeth

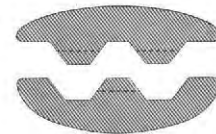

### DARDIK

17-150  
2 : 3 rows of teeth



**17-151**  
Width of jaws  
1,5 mm  
Length  
150mm

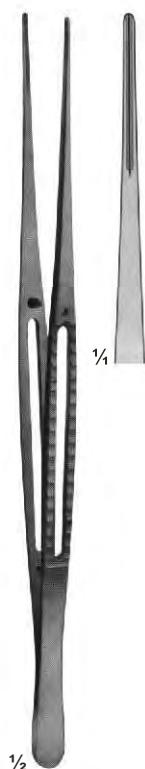

**17-152**  
1,5 mm  
200 mm



**17-153**  
1,5 mm  
240 mm



**17-154**  
1,5 mm  
300 mm

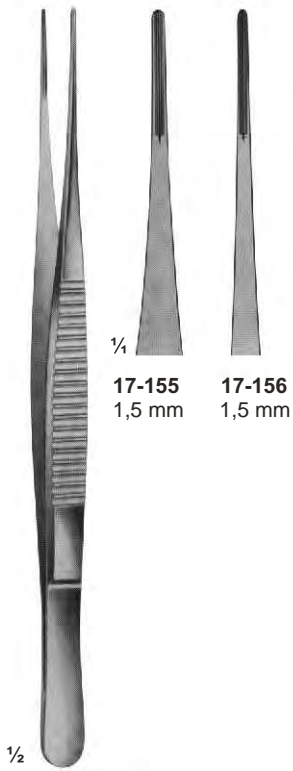

**17-155**  
1,5 mm

**17-156**  
1,5 mm

**17-155 - 156**  
DE BAKEY  
150 mm  
300 mm

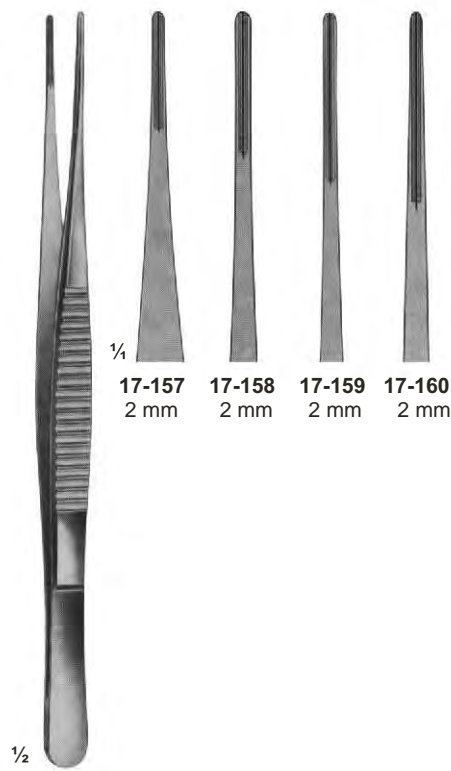

**17-157**  
2 mm

**17-158**  
2 mm

**17-159**  
2 mm

**17-160**  
2 mm

**17-157 - 160**  
DE BAKEY  
150 mm 200 mm  
300 mm 240 mm

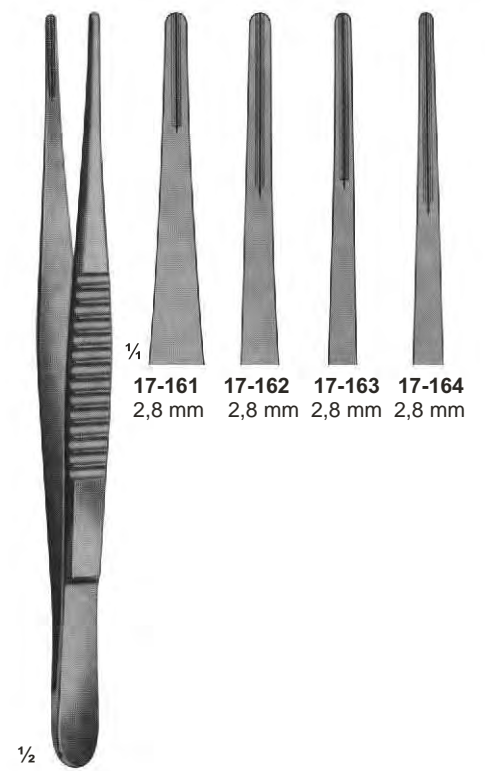

**17-161**  
2,8 mm

**17-162**  
2,8 mm

**17-163**  
2,8 mm

**17-164**  
2,8 mm

**17-161 - 164**  
DE BAKEY  
150 mm 200 mm  
300 mm 240 mm

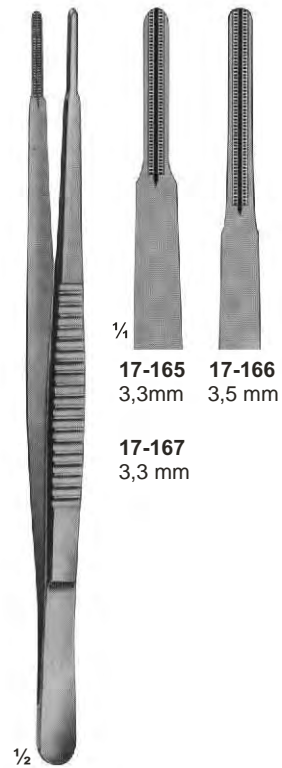

**17-165**  
3,3mm

**17-166**  
3,5 mm

**17-167**  
3,3 mm

**17-165 - 167**  
DE BAKEY  
200 mm  
300 mm 240 mm

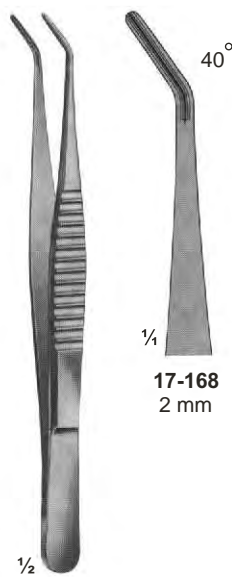

**17-168**  
2 mm

**17-168**  
DE BAKEY  
150 mm

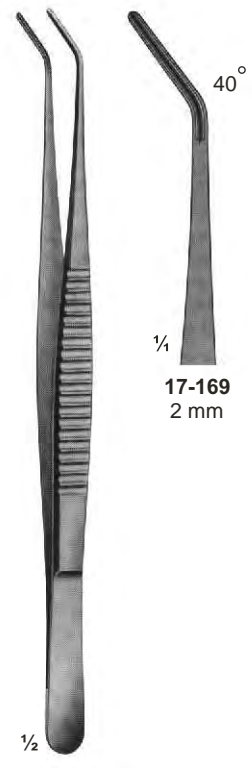

**17-169**  
2 mm

**17-169**  
DE BAKEY  
200 mm

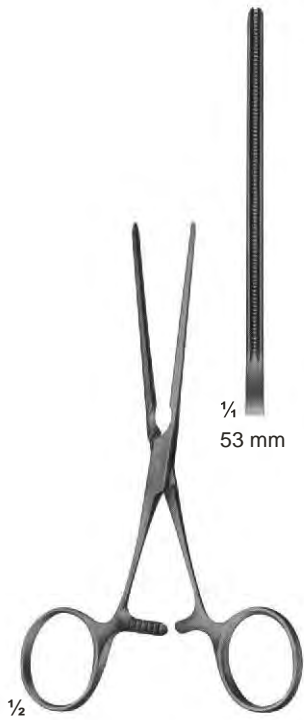

**17-170**  
DE-BAKEY  
gerade straight  
130 mm

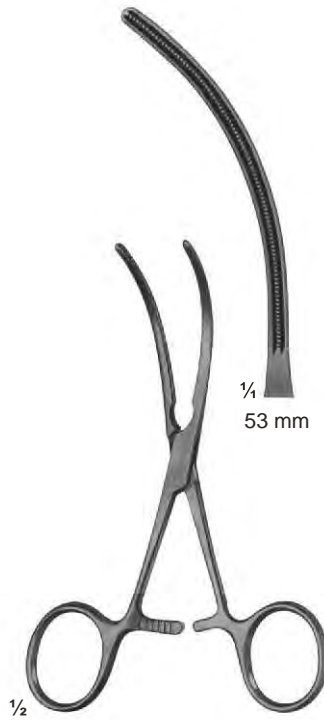

**17-171**  
DE-BAKEY  
Maul gebogen  
curved jaws  
125 mm

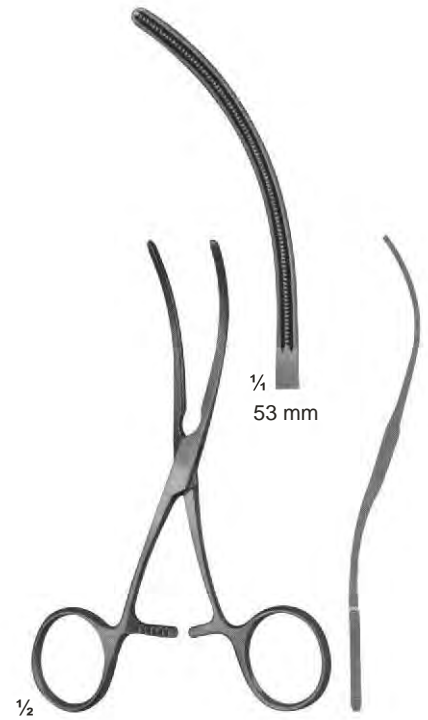

**17-172**  
DE-BAKEY  
S-shaped curved  
125 mm

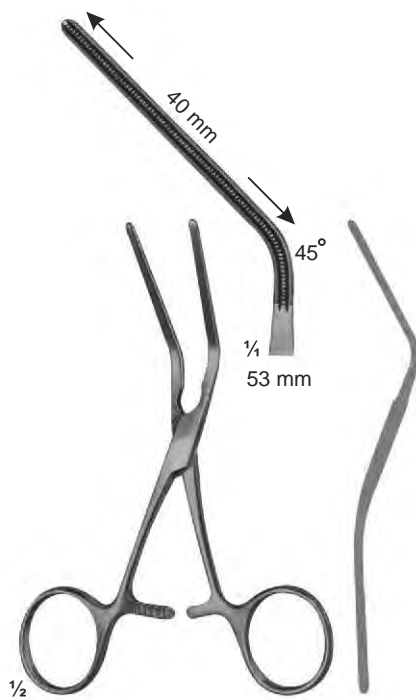

**17-173**  
DE-BAKEY  
45° winklig gebogen  
angled 45°  
125 mm



**17-174**  
DE-BAKEY  
90° winklig gebogen  
angled 90°  
105 mm



graduated



1/2

**17-175 - 178**  
CASTANESA

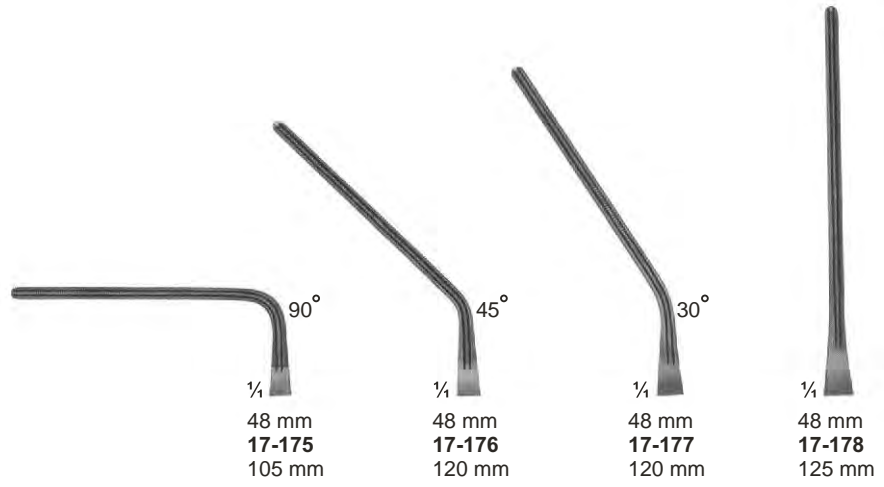

graduated



1/2

**17-179 - 182**  
CASTANESA

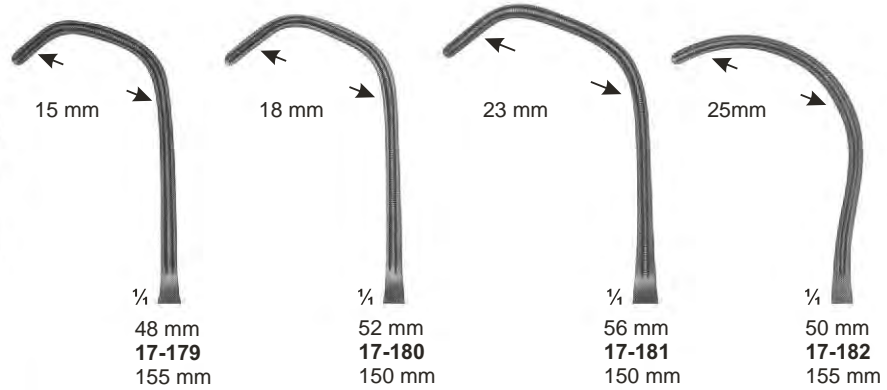

# Anastomosis-and Multi-Purpose-Clamps-Pediatric types

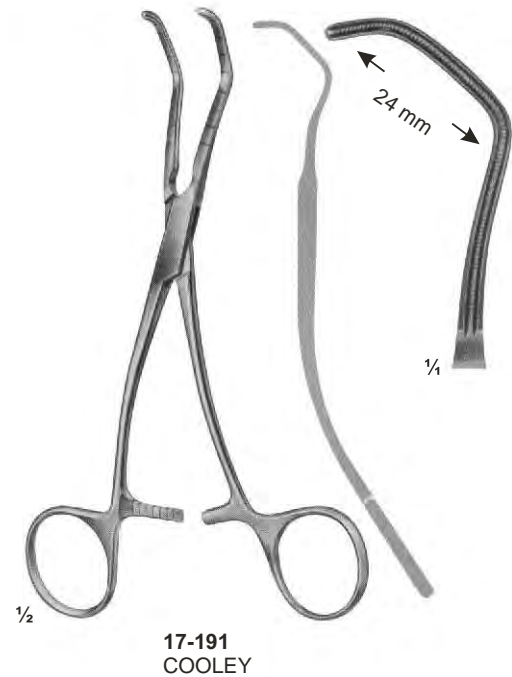
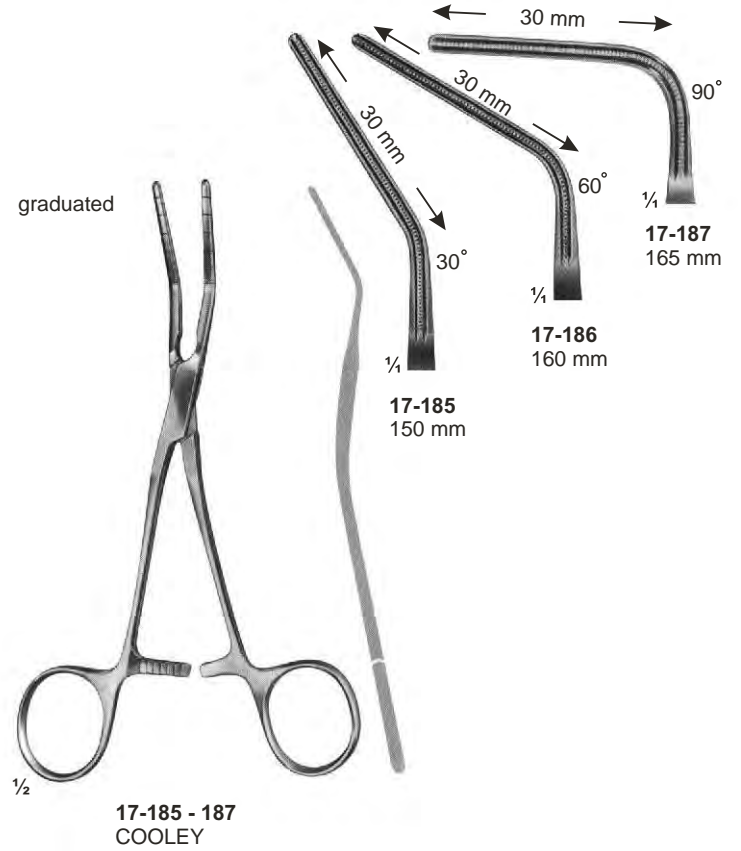
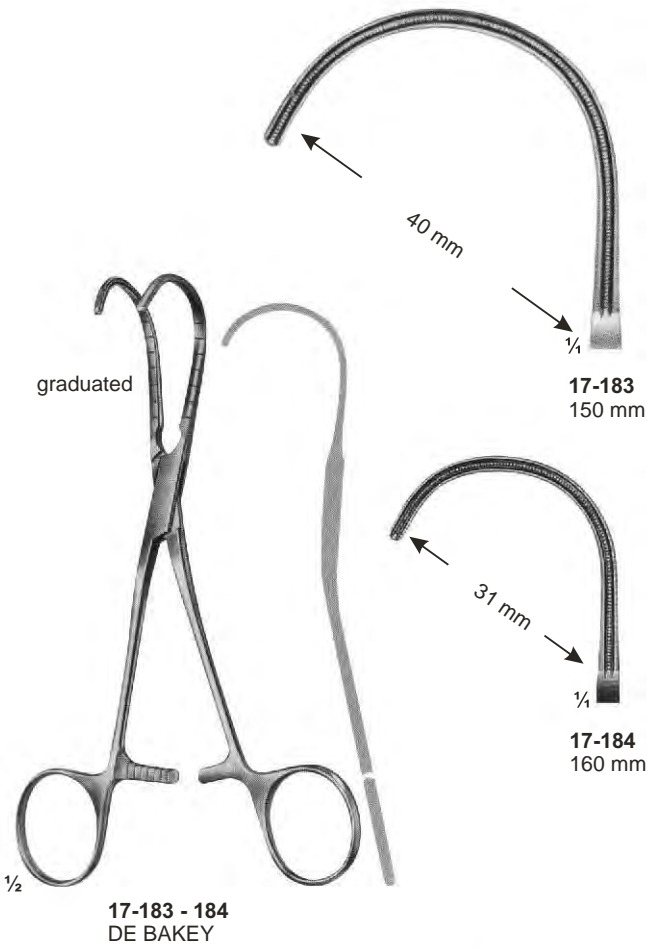

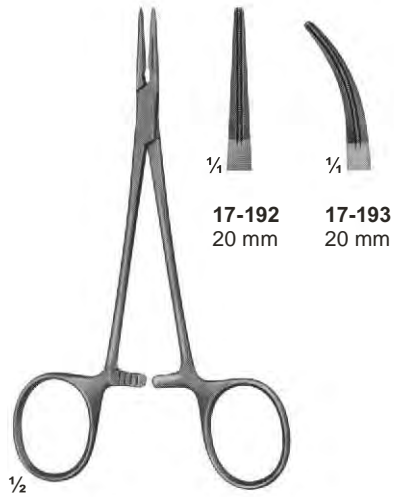

**17-192**  
20 mm

**17-193**  
20 mm

**17-192 - 193**  
125 mm



**17-194**  
27 mm

**17-195**  
27 mm

**17-194 - 195**  
165 mm



**17-196**  
40 mm

**17-197**  
40 mm

**17-196 - 197**  
DE BAKEY-BAINRIDGE  
155 mm

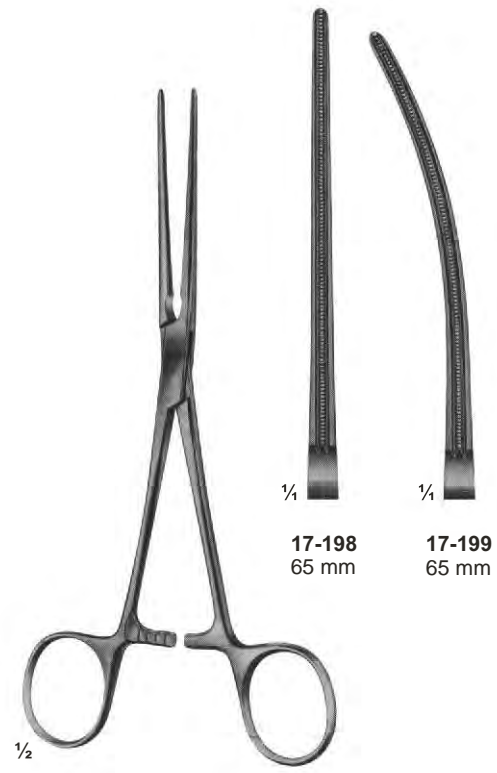

**17-198**  
65 mm

**17-199**  
65 mm

**17-198 - 199**  
DE BAKEY-BAINRIDGE  
180 mm

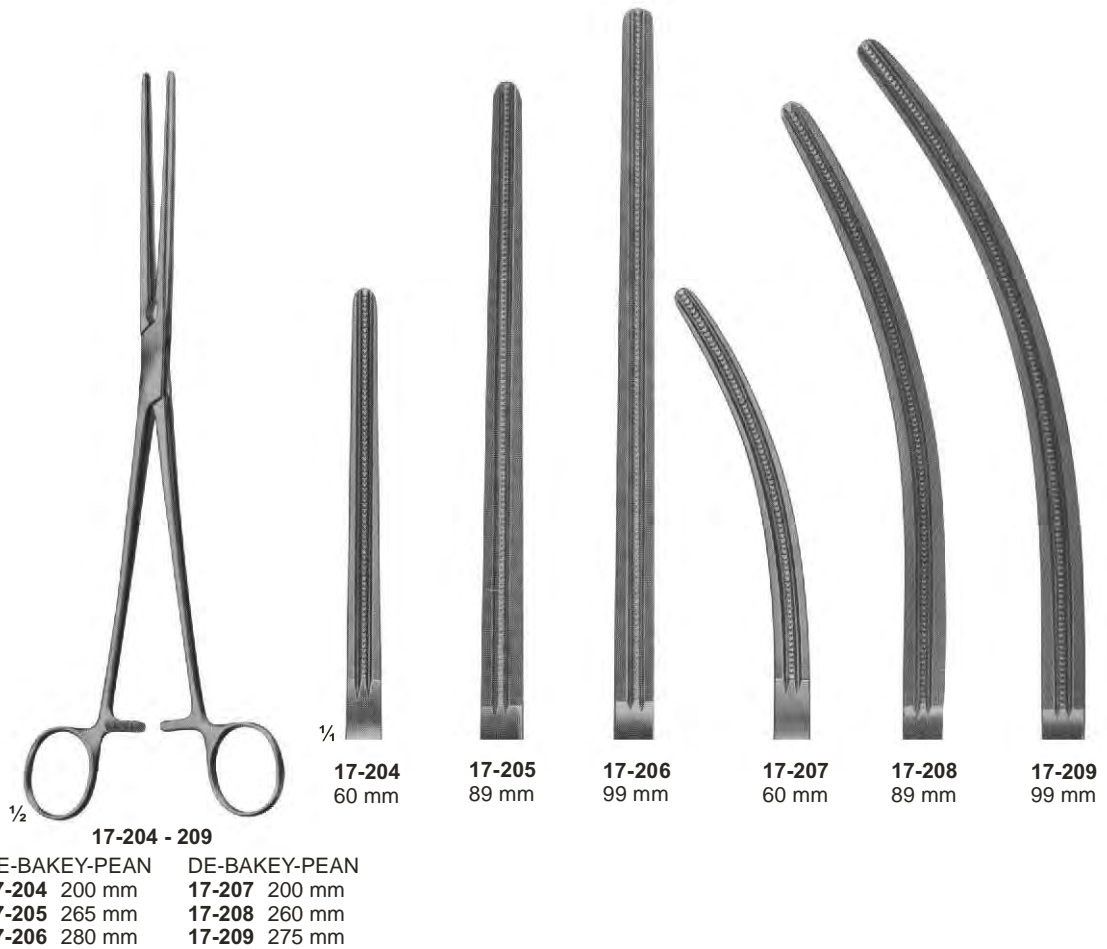

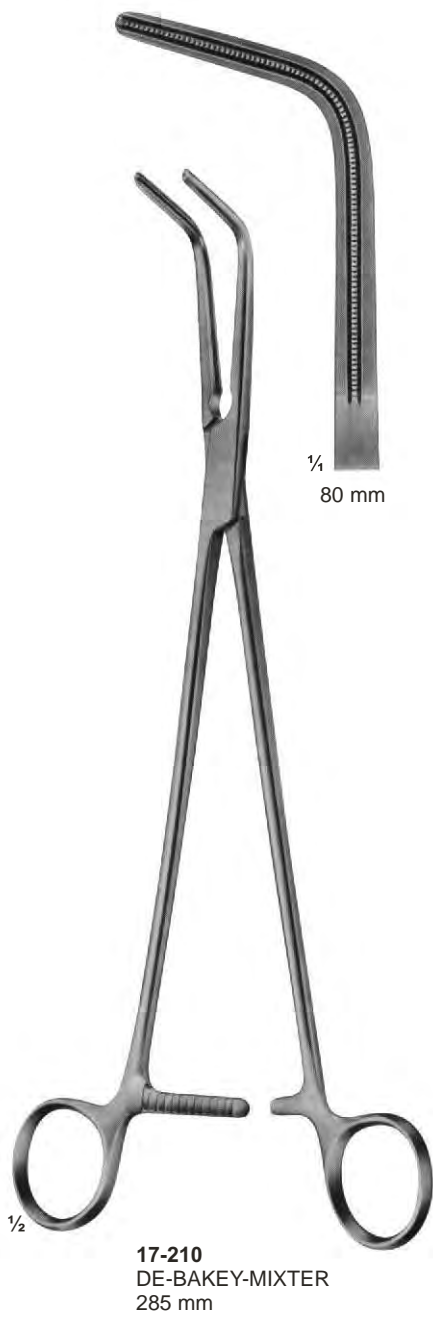

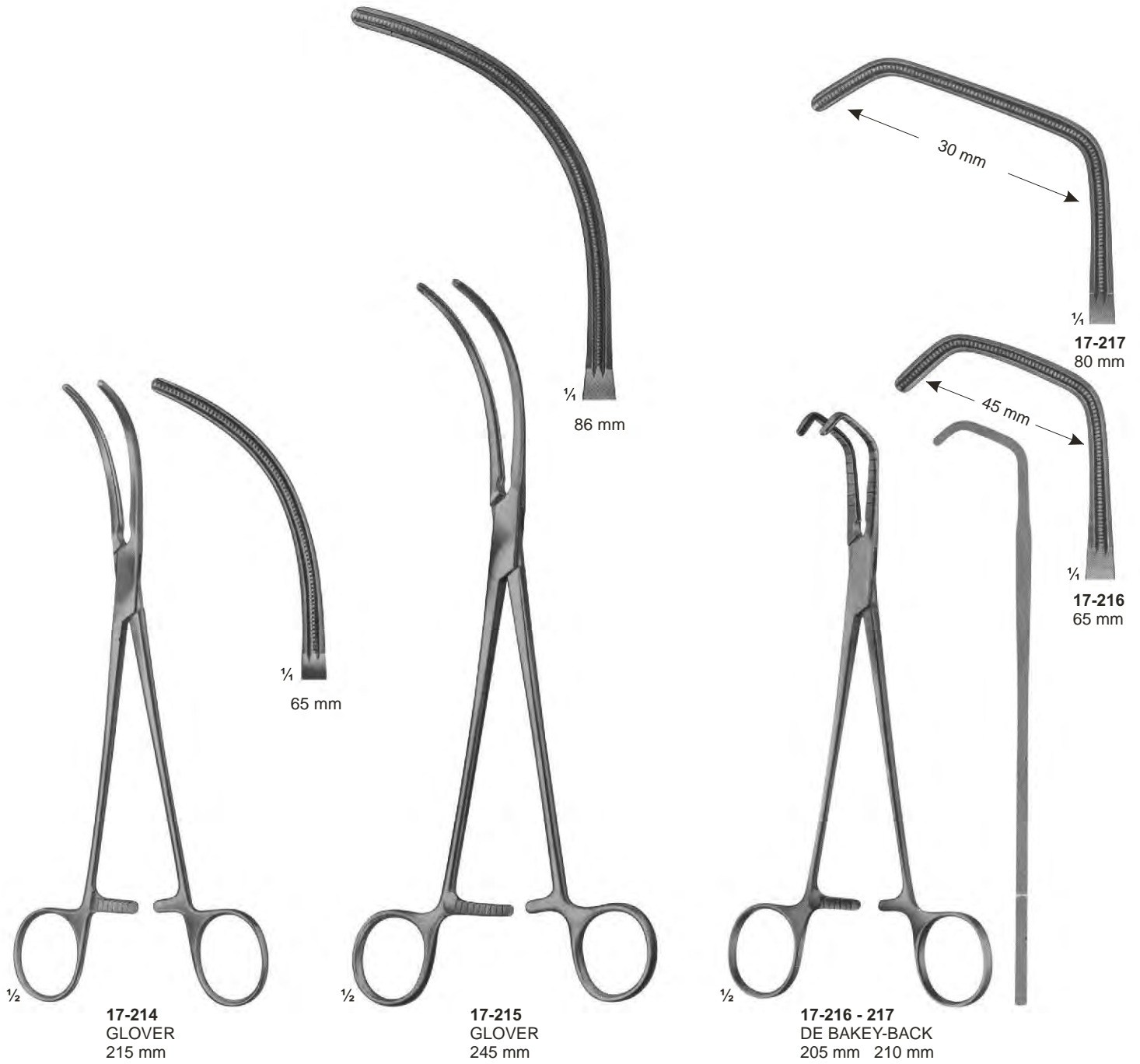



1/2



1/4  
**17-218**  
86 mm



1/4  
**17-219**  
86 mm



1/4  
**17-220**  
86 mm

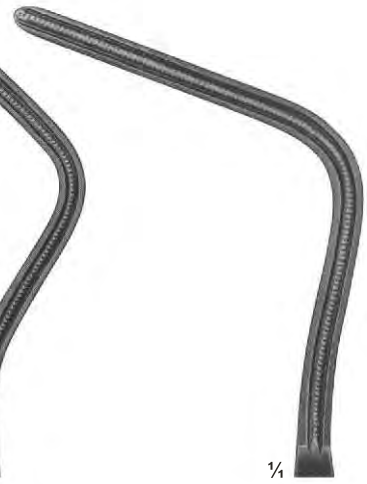

1/4  
**17-221**  
86 mm

**17-218 - 221**  
DE BAKY-HARKEN  
17-218 - 255 mm  
17-219 - 245 mm  
17-220 - 245 mm  
17-221 - 245 mm



1/2

**17-222 - 226**  
DE BAKY

Total Length:

Length of jaws:

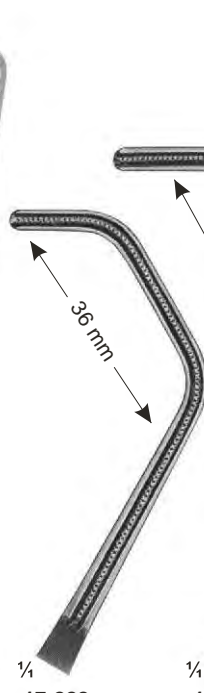

1/4  
**17-222**  
220 mm  
85 mm

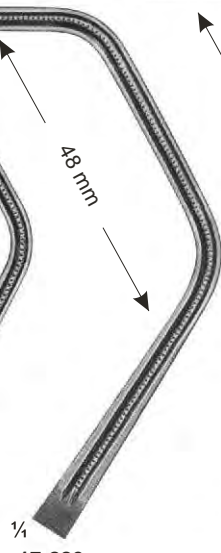

1/4  
**17-223**  
256 mm  
95 mm

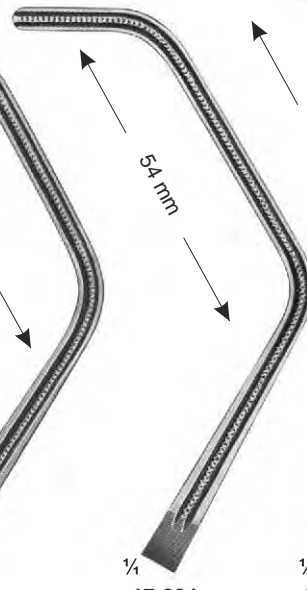

1/4  
**17-224**  
270 mm  
99 mm

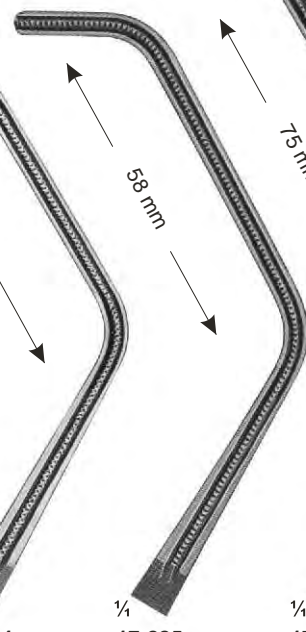

1/4  
**17-225**  
270 mm  
103 mm

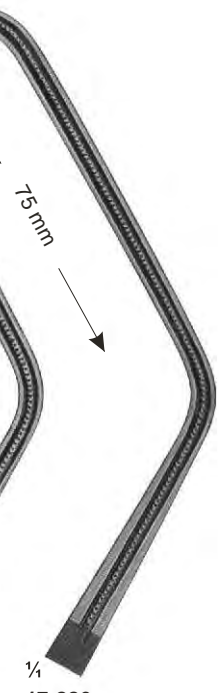

1/4  
**17-226**  
280 mm  
119 mm



1/2

**17-227 - 229**  
DE BAKEY-SATINSKY  
235 mm, 240 mm, 245 mm

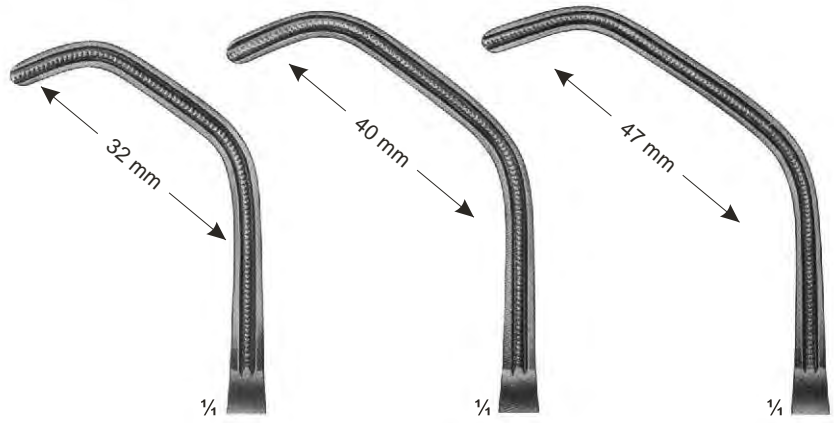

1/4

**17-227**  
68 mm

1/4

**17-228**  
76 mm

1/4

**17-229**  
84 mm



1/2

**17-230 - 231**  
DE BAKEY  
170 mm, 165 mm



1/4

**17-230**  
50 mm

1/4

**17-231**  
50 mm



1/2

**17-232**  
DE BAKEY  
165 mm

1/4

50 mm



**17-233 - 235**  
DE BAKEY  
205 mm, 225 mm, 240 mm



$\frac{1}{4}$   
**17-233** 41 mm  
**17-234** 65 mm  
**17-235** 80 mm



**17-236 - 238**  
DE BAKEY  
200 mm, 225 mm, 240 mm



$\frac{1}{4}$   
**17-236** 41 mm  
**17-237** 65 mm  
**17-238** 80 mm



**17-239**  
DE BAKEY  
210 mm



$\frac{1}{4}$   
51 mm



**17-240**  
DE BAKEY  
210 mm

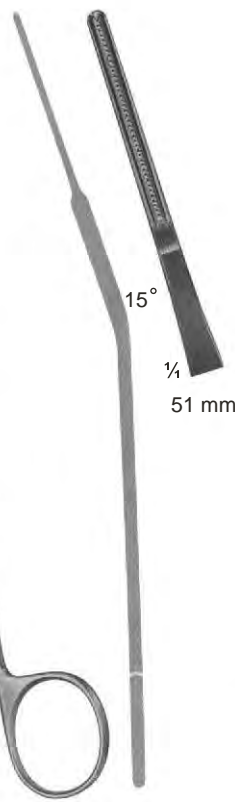

15°  
 $\frac{1}{4}$   
51 mm



**17-241**  
DE BAKEY  
160 mm



$\frac{1}{4}$   
56 mm

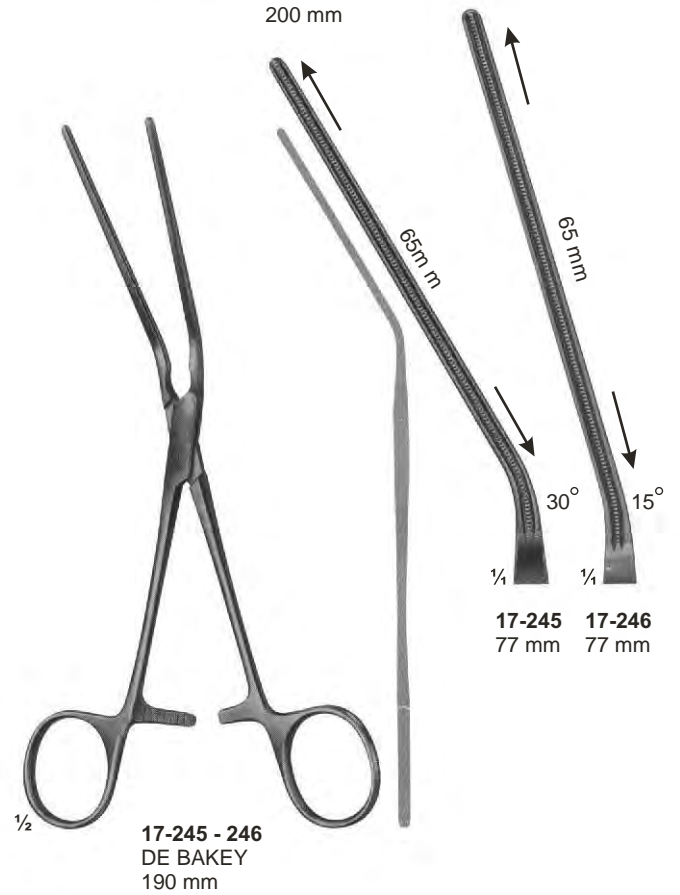
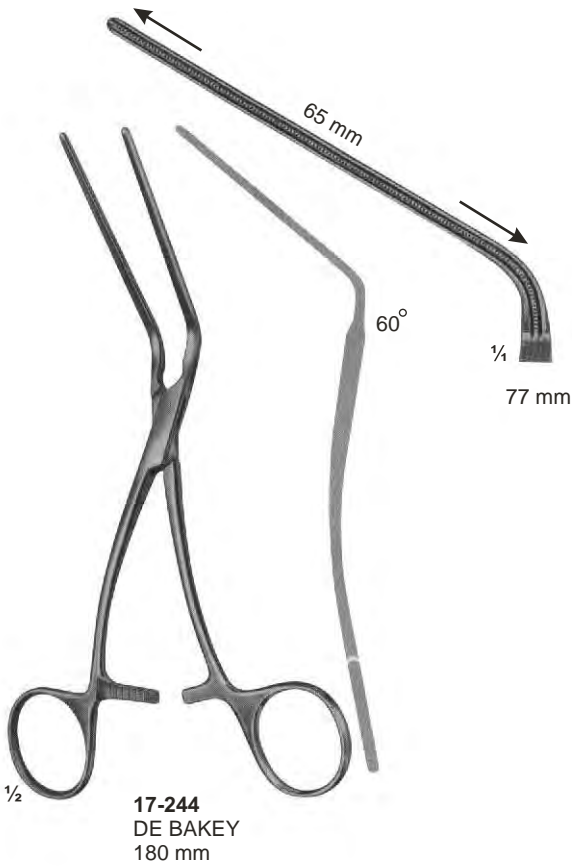
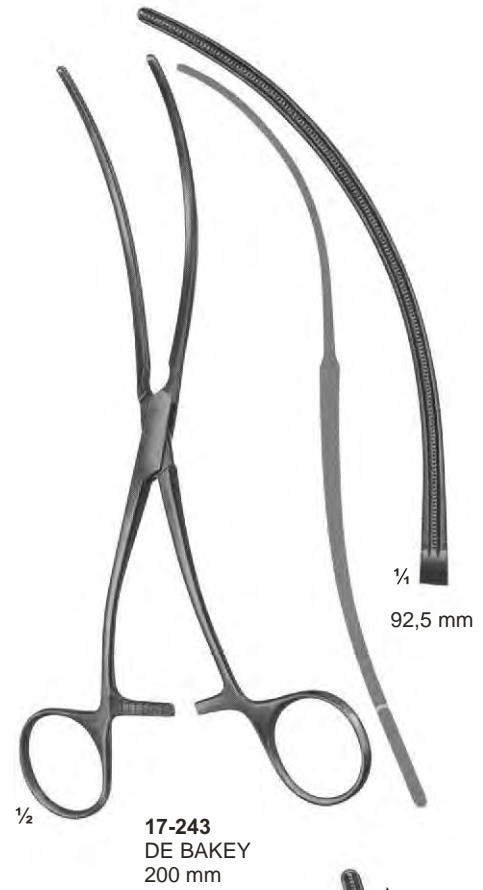
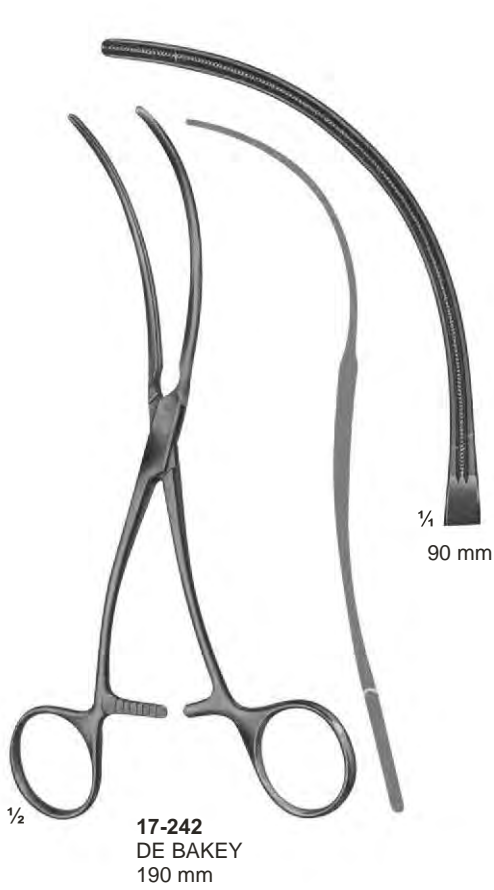



**17-247**  
LELAND-JONES  
195 mm



**17-248**  
DE BAKEY  
200 mm

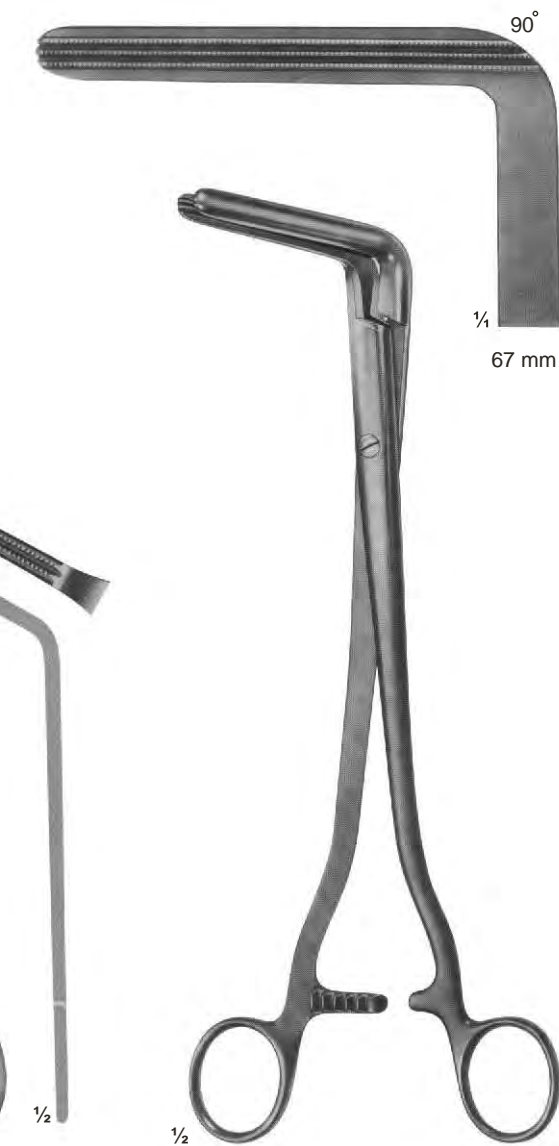

**17-249**  
WERTHEIM  
250 mm

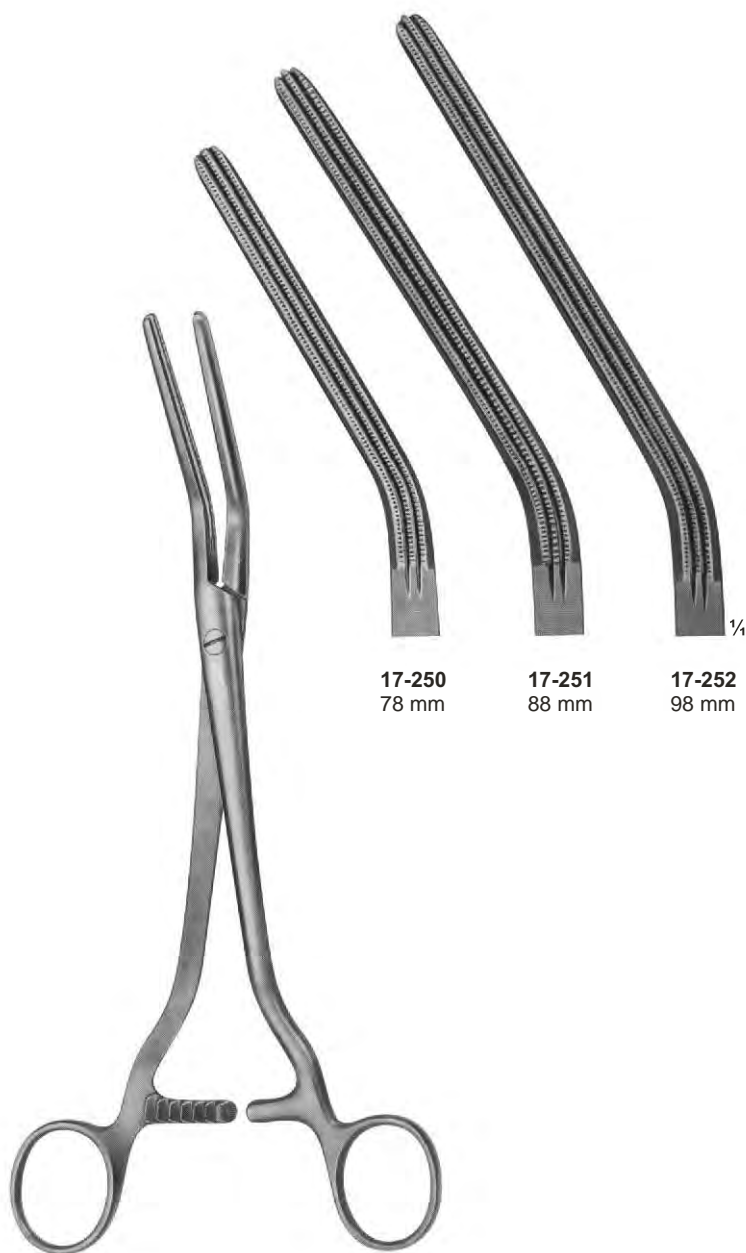

**17-250**  
78 mm

**17-251**  
88 mm

**17-252**  
98 mm

**17-250 - 252**  
DICK  
255 mm, 265 mm, 275 mm



67 mm

70°

¼

93 mm

½

**17-253**  
MORRIS  
175 mm

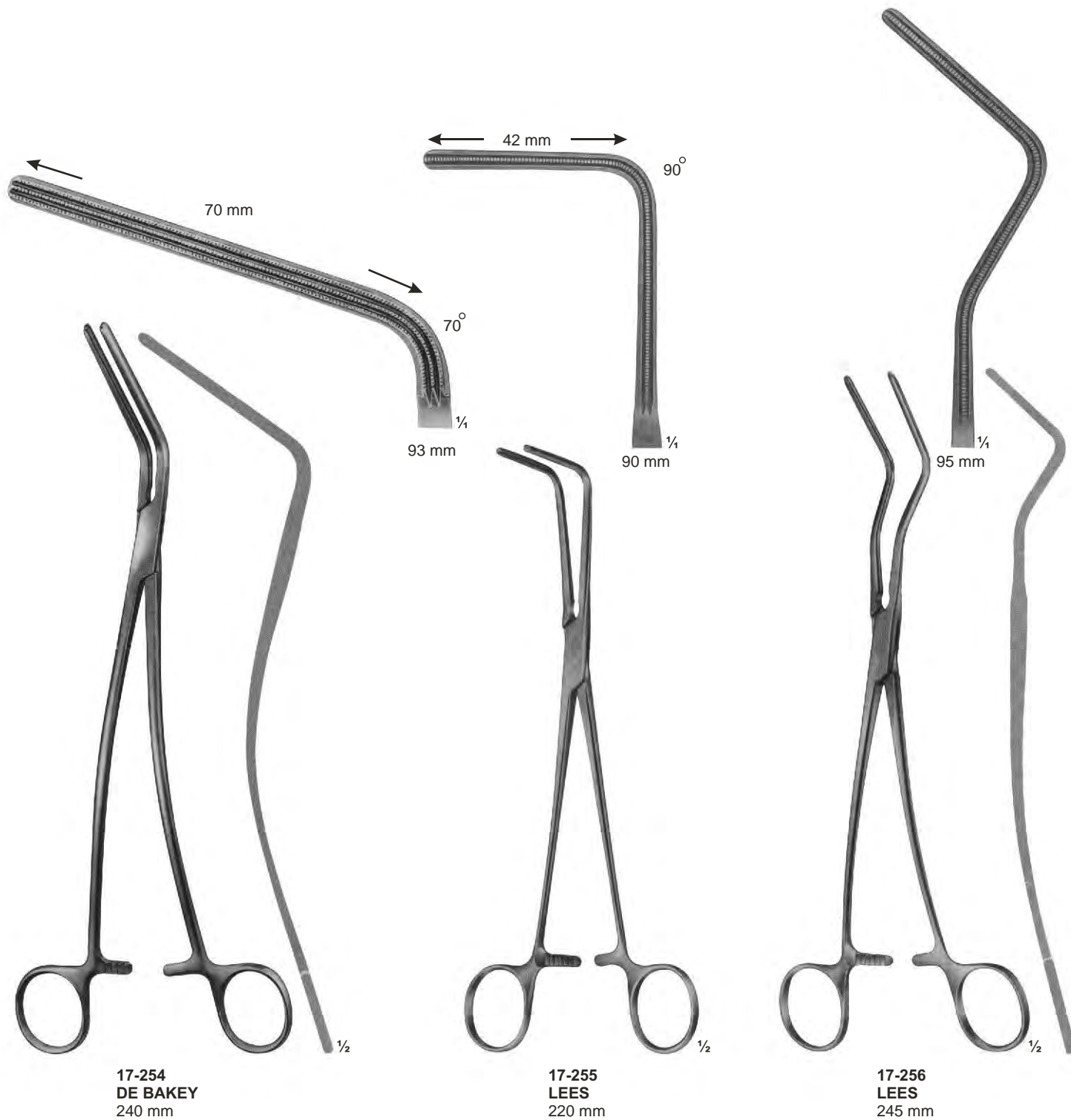

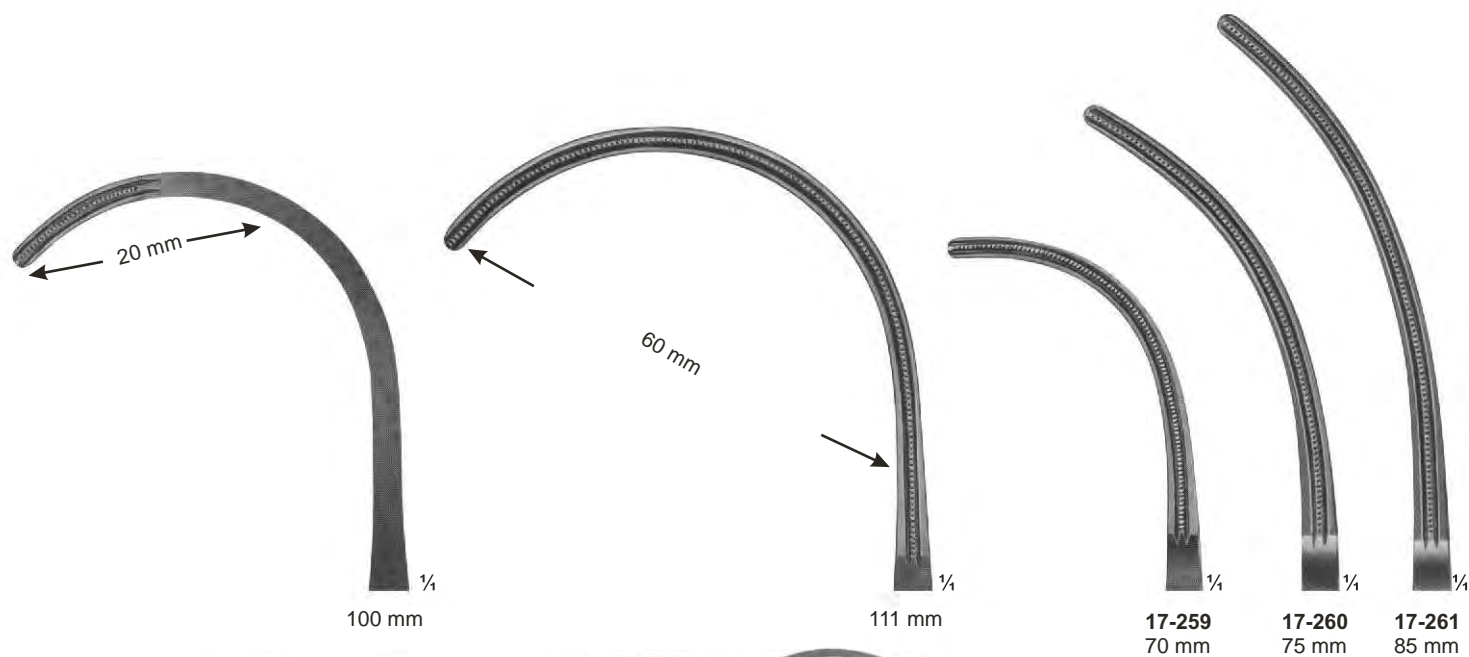

**17-257  
DE BAKEY**  
265 mm



**17-258  
DE BAKEY**  
270 mm



**17-259 - 261  
DE BAKEY**  
255 mm, 265 mm, 280 mm



17-262 95 mm   17-263 110 mm   17-264 130 mm   17-265 140 mm

**17-262 - 265**  
DE BAKEY  
250 mm, 300 mm,  
315 mm, 330 mm



115 mm

**17-266**  
DE BAKEY  
300 mm

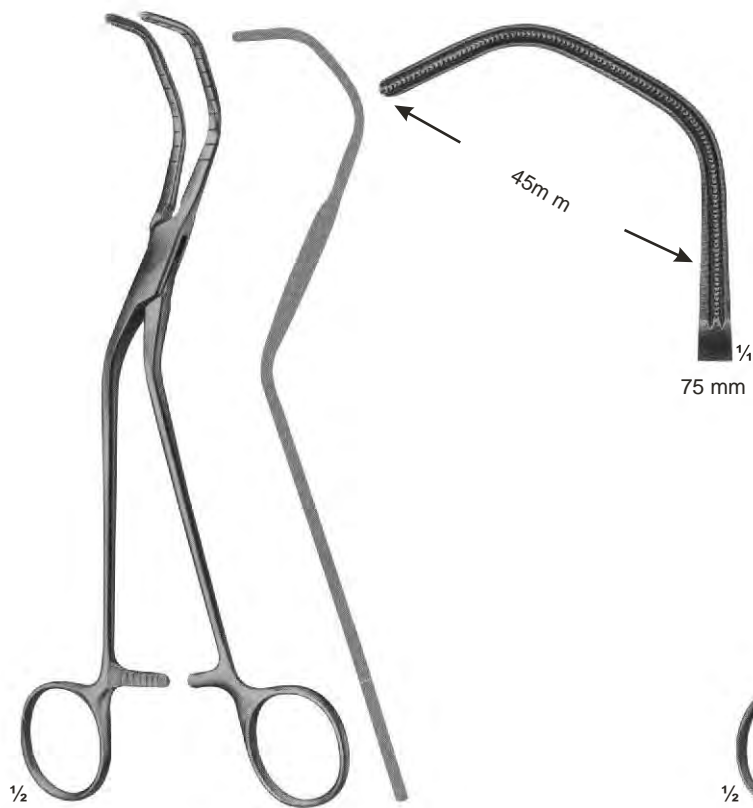

**17-267  
DIETRICH**  
210 mm

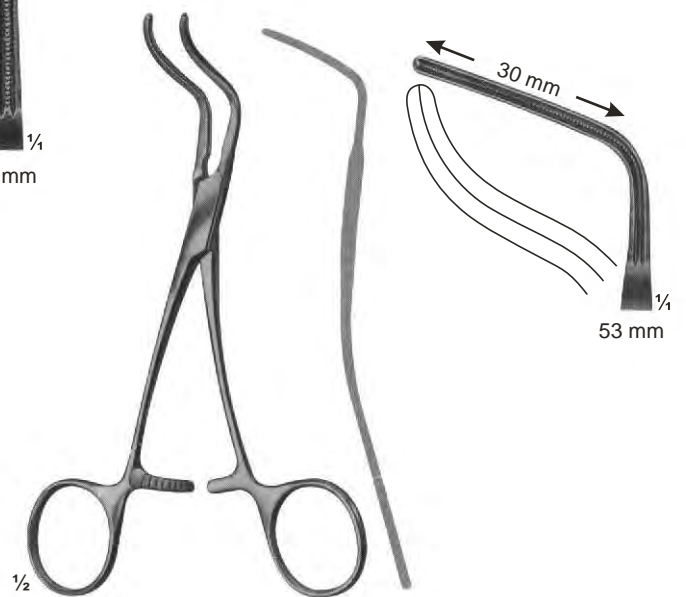

**17-268  
SUBRAMANIAN**  
155 mm

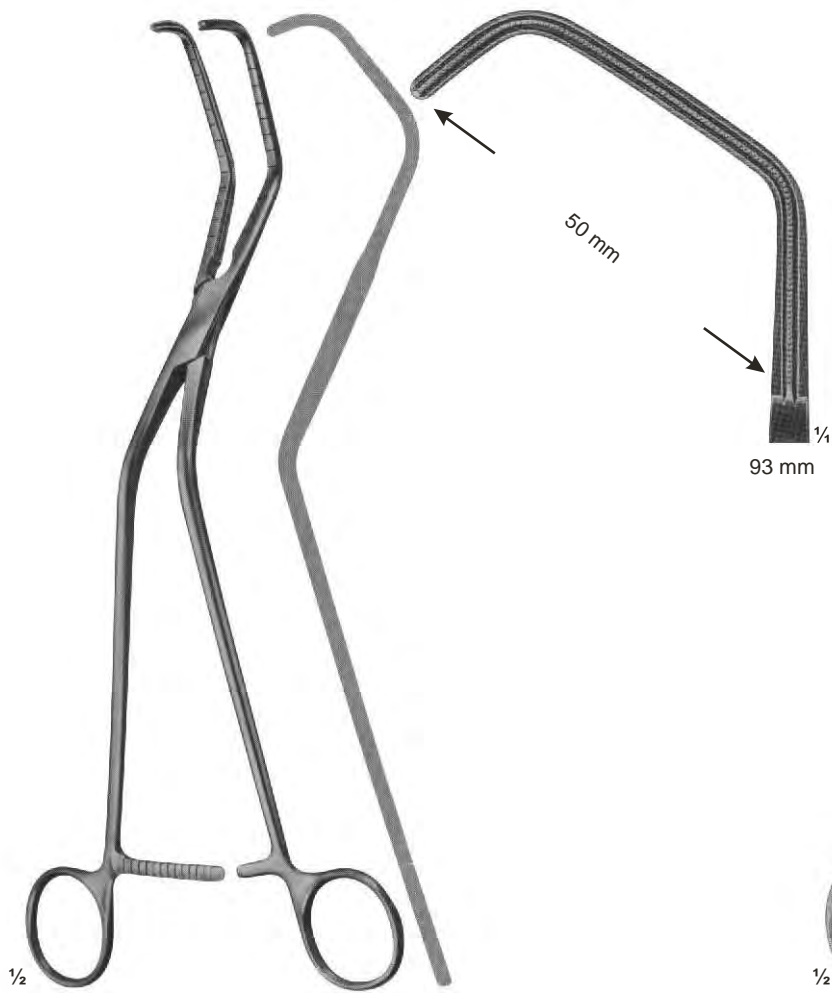

**17-269**  
**OCHSNER**  
260 mm

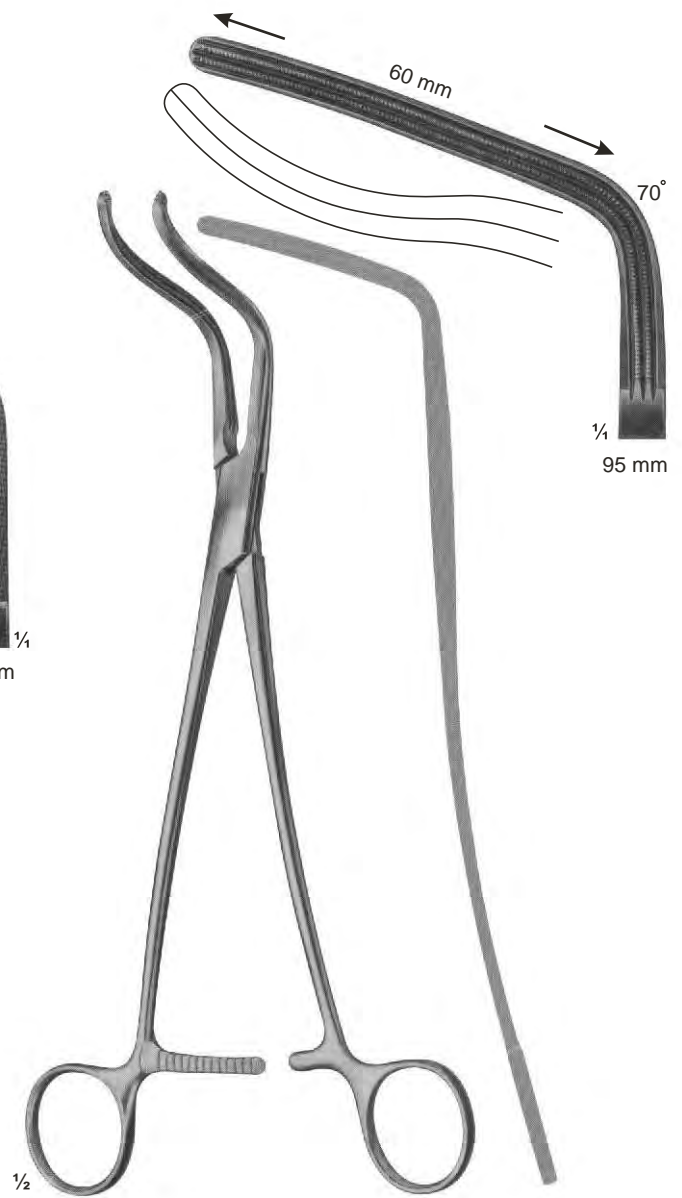

**17-270**  
**DE BAKEY**  
265 mm

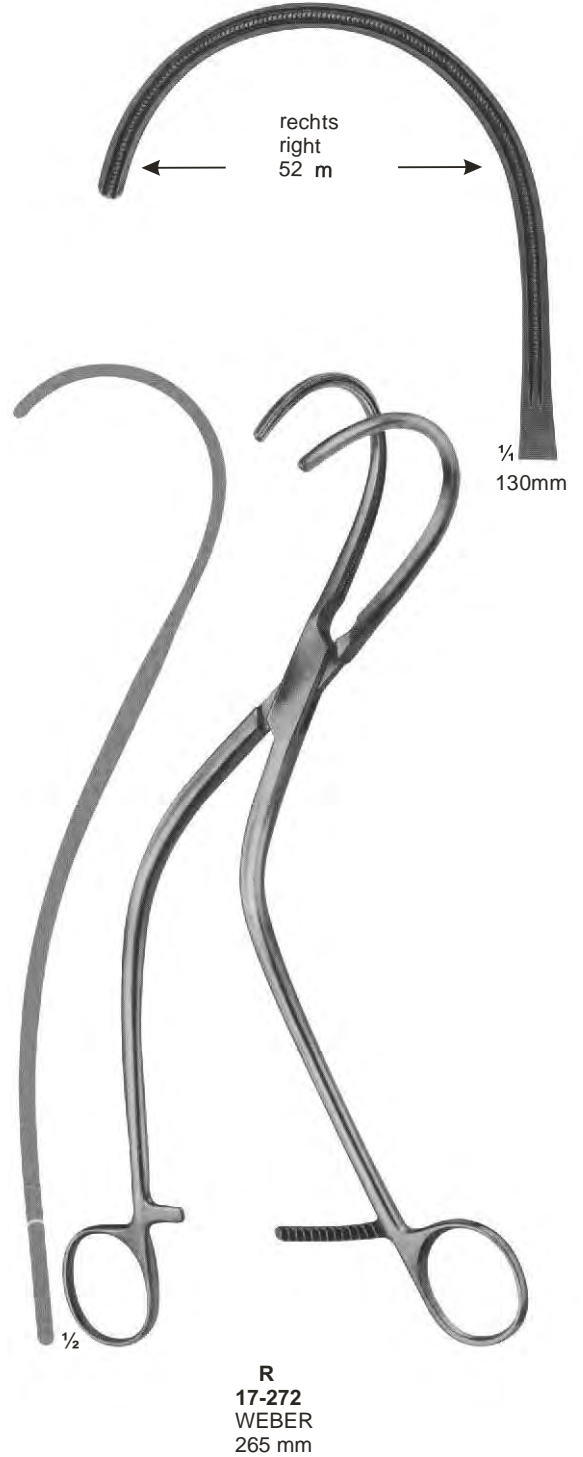
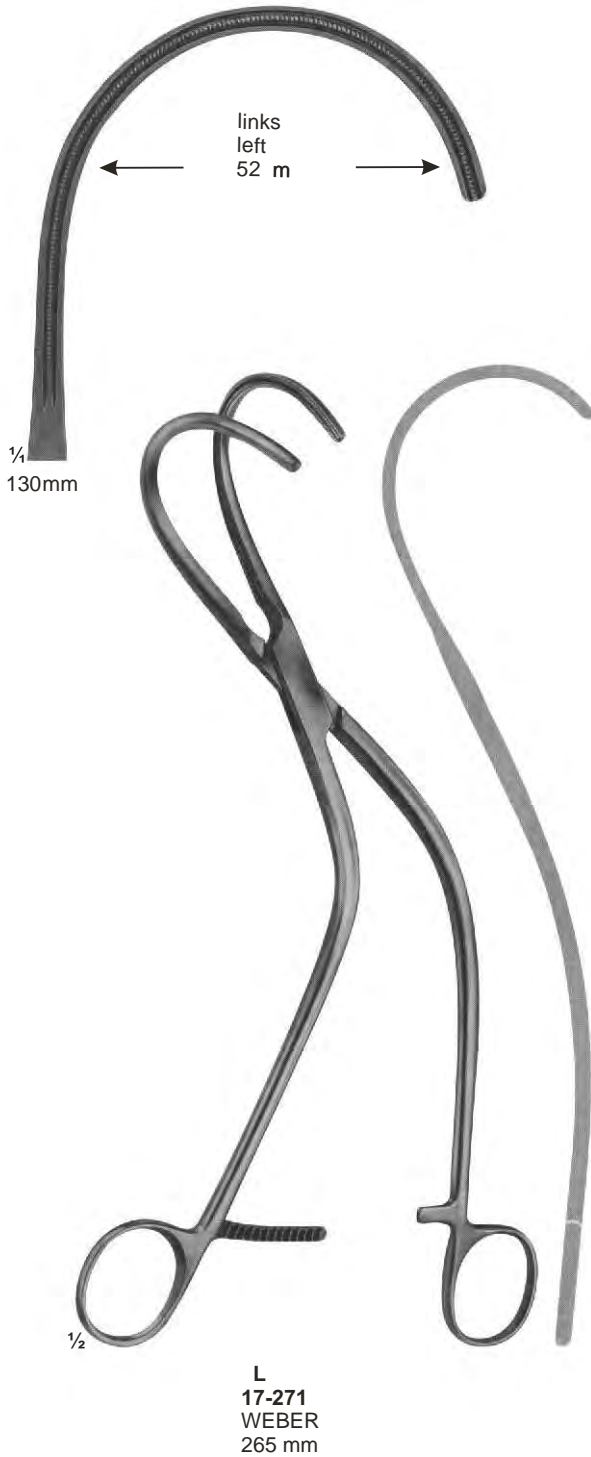



1/2  
**17-273 - 276**  
DE BAKEY

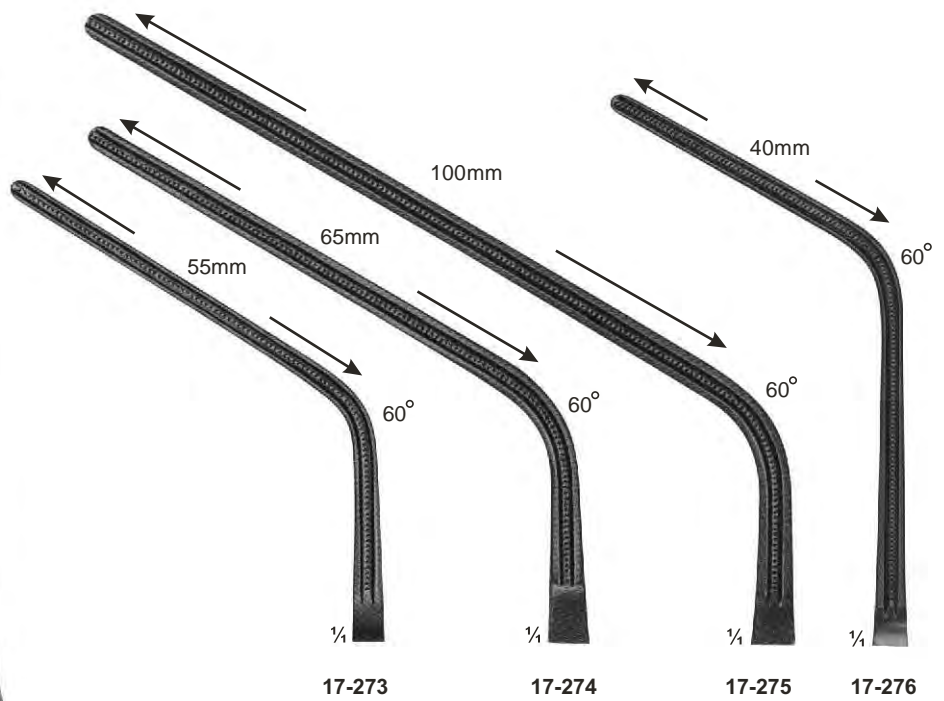

Total Length: 230 mm 280 mm 305 mm 240 mm  
Length of jaws: 85 mm 100 mm 135 mm 93 mm



1/2  
**17-277 - 280**  
DE BAKEY

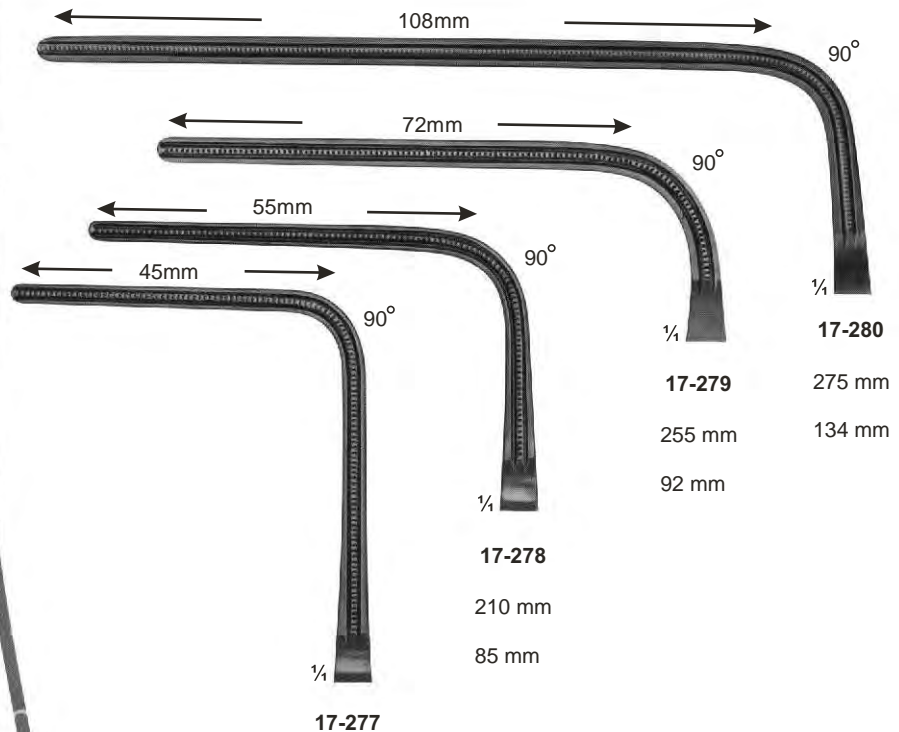

Total Length: 225 mm  
Length of jaws: 93 mm



**17-281 - 282**  
COOLEY  
125 mm, 115 mm

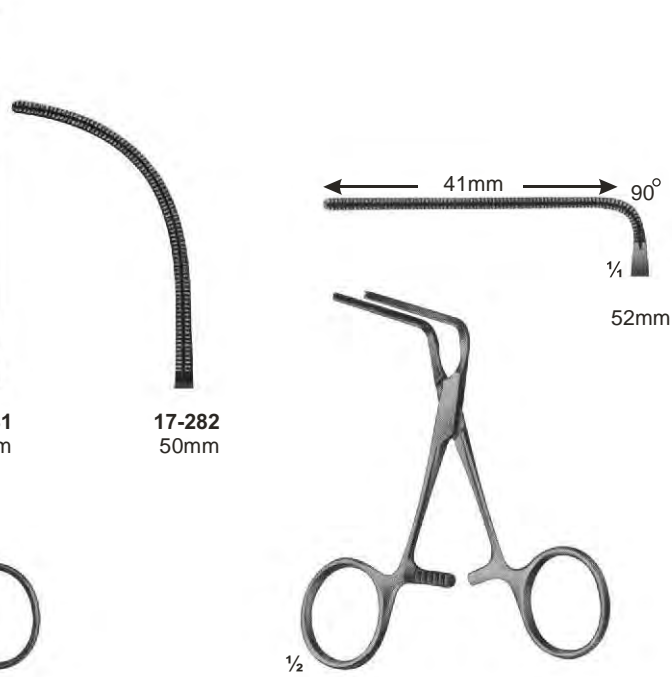

**17-283**  
COOLEY  
100 mm

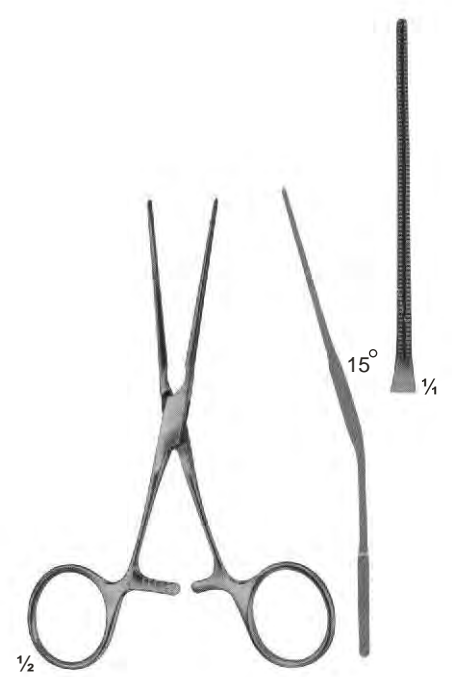

**17-284**  
COOLEY  
125 mm

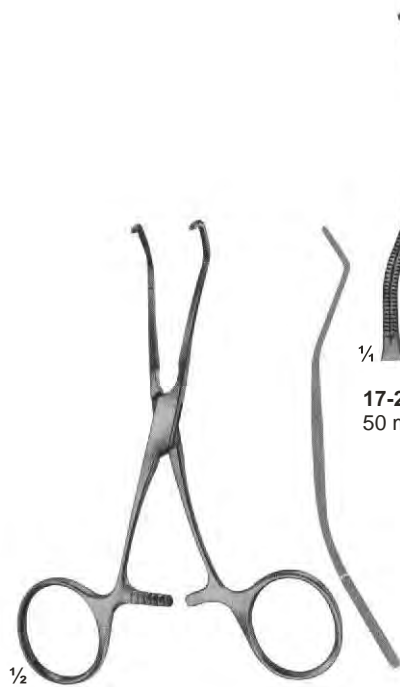

**17-285 - 286**  
COOLEY  
120 mm, 115 mm

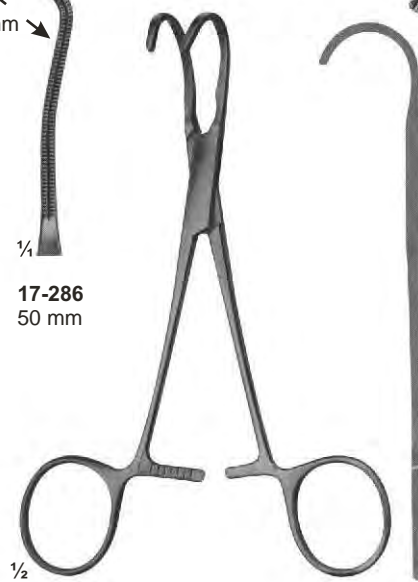
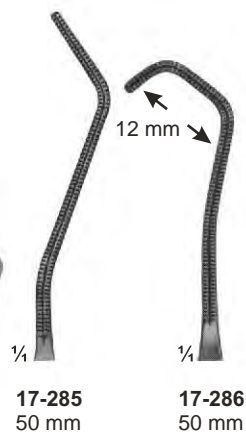

**17-287 - 288**  
COOLEY-BACK  
150 mm, 115 mm

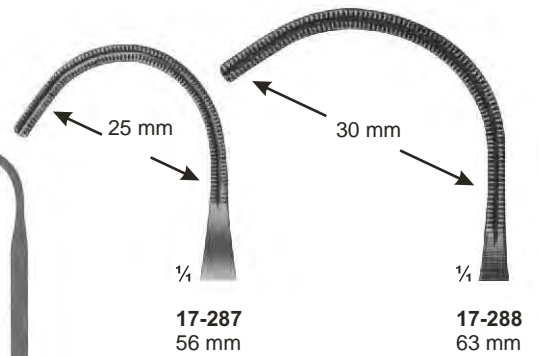

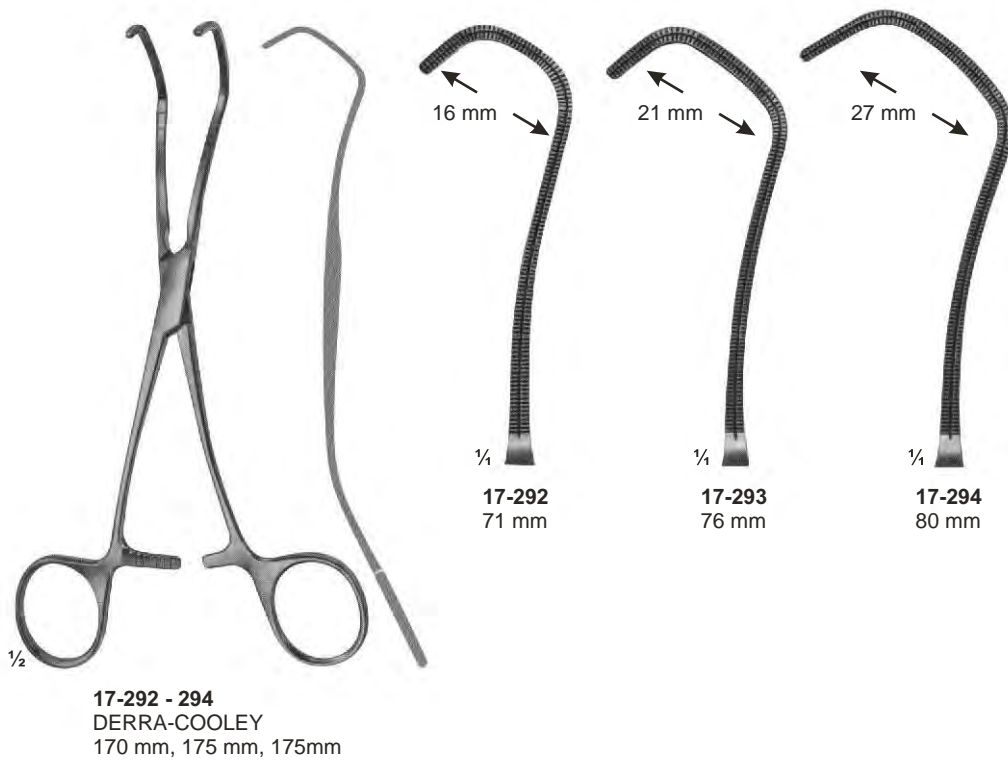
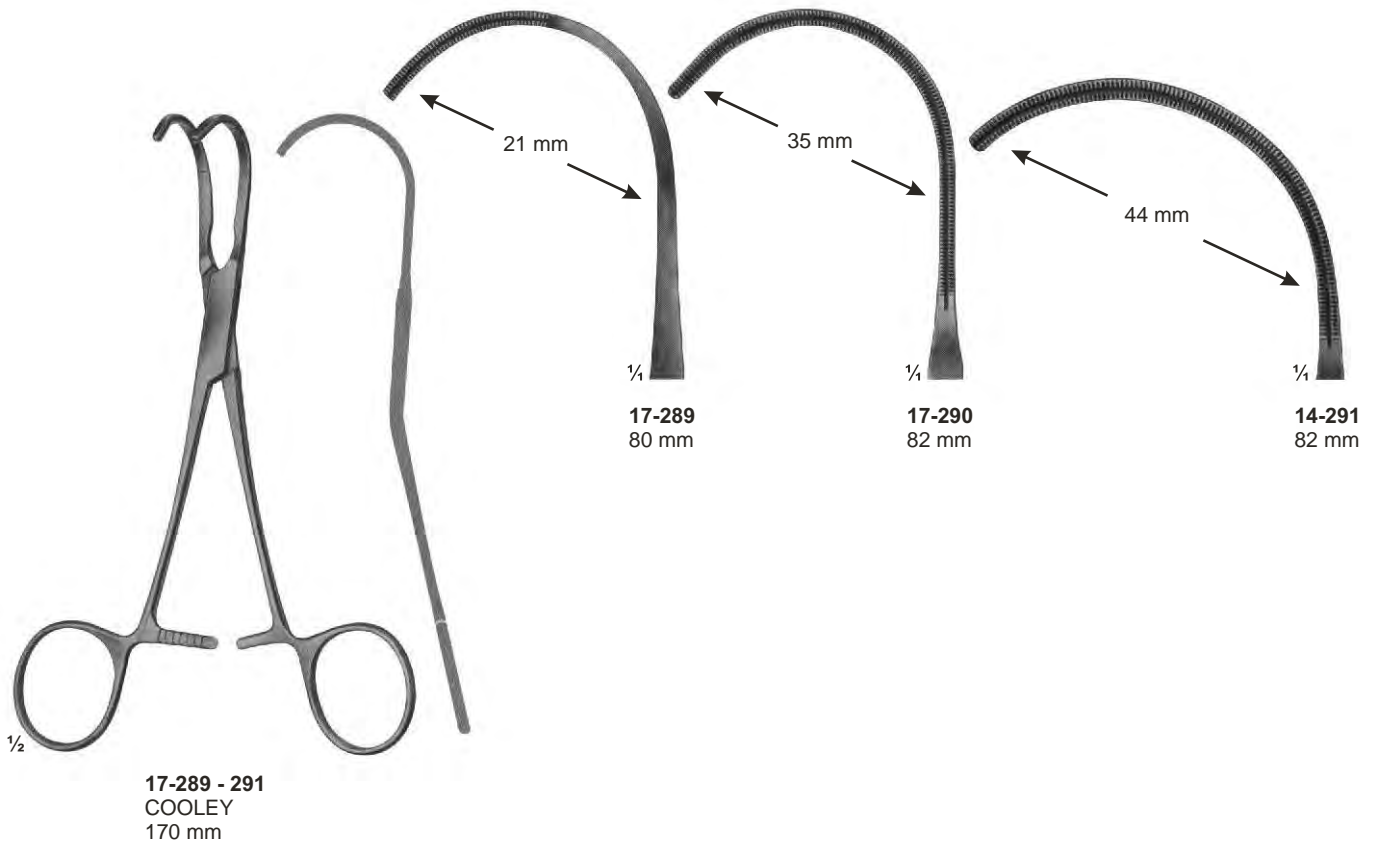

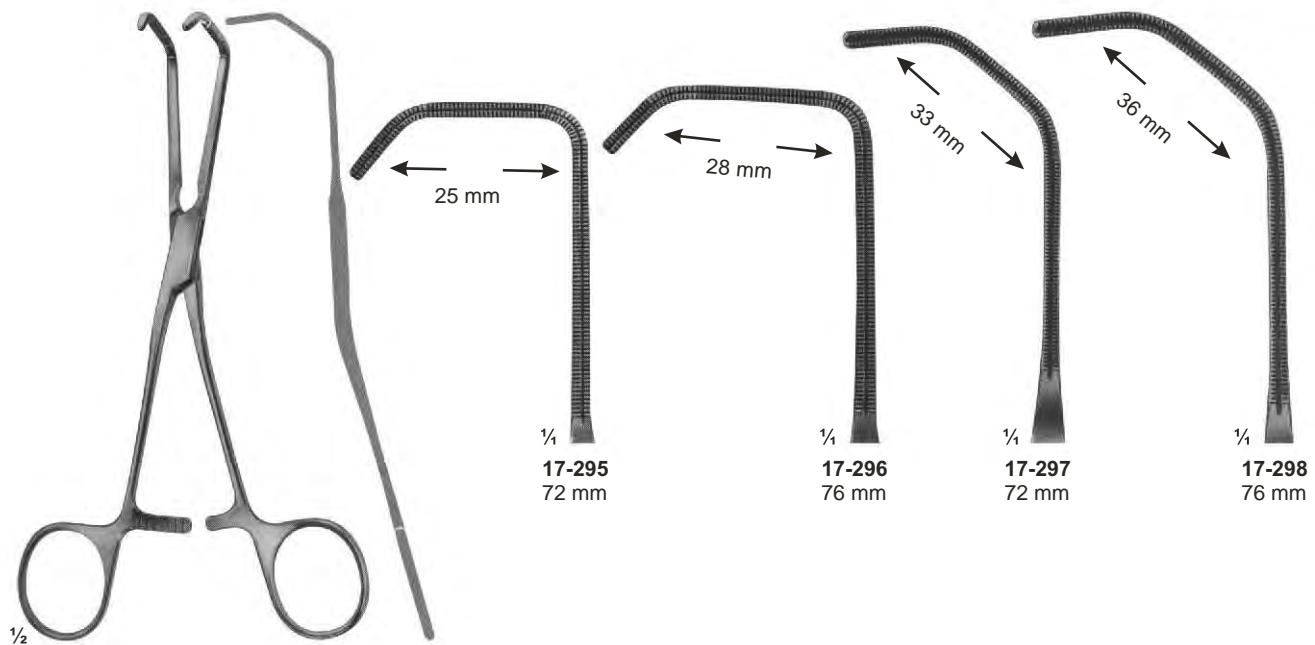

**17-295 - 298**  
**COOLEY**  
 165 mm, 165 mm  
 175 mm, 180 mm

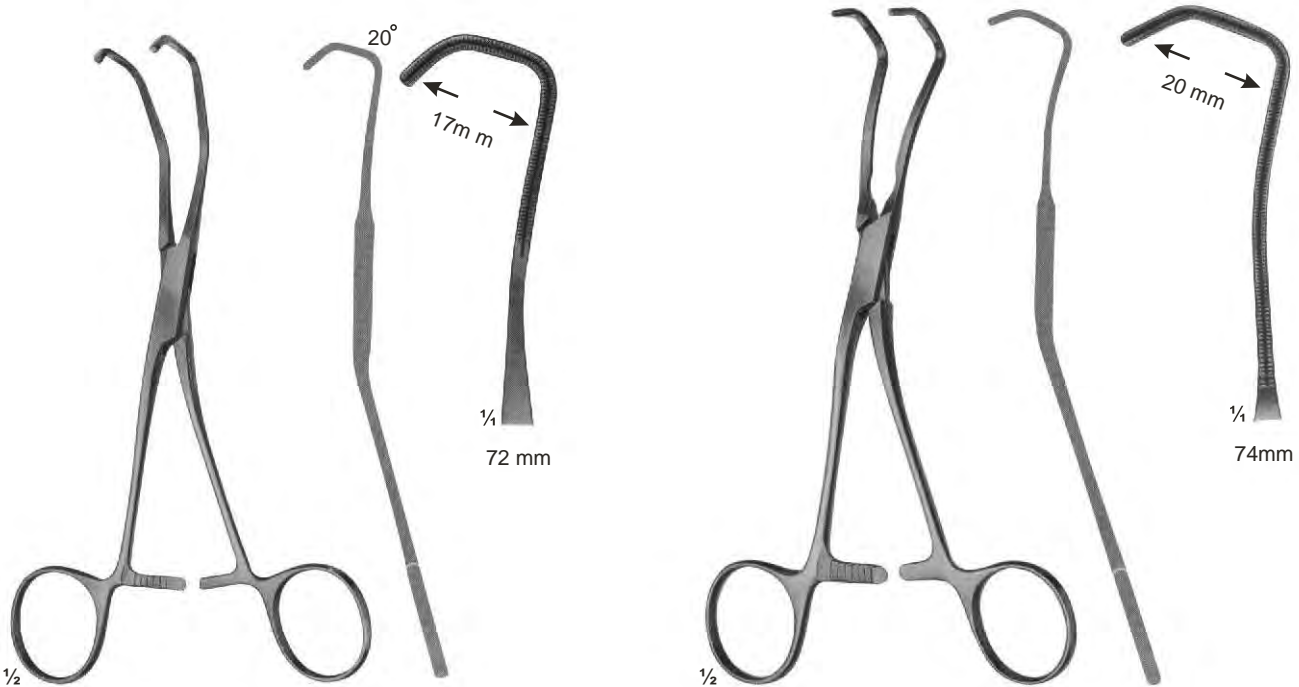

**17-299**  
**COOLEY**  
 170 mm

**17-300**  
**COOLEY**  
 175 mm

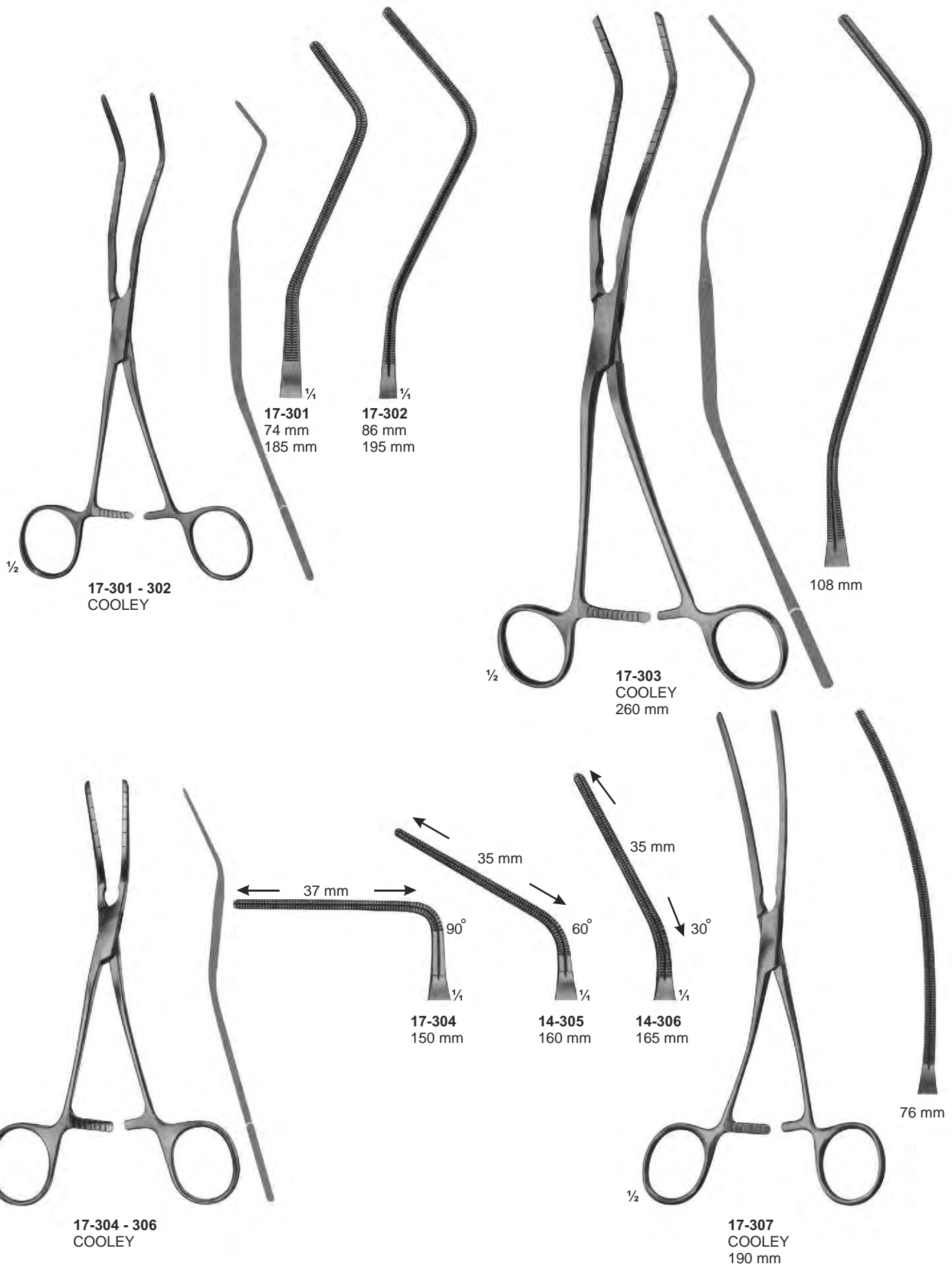

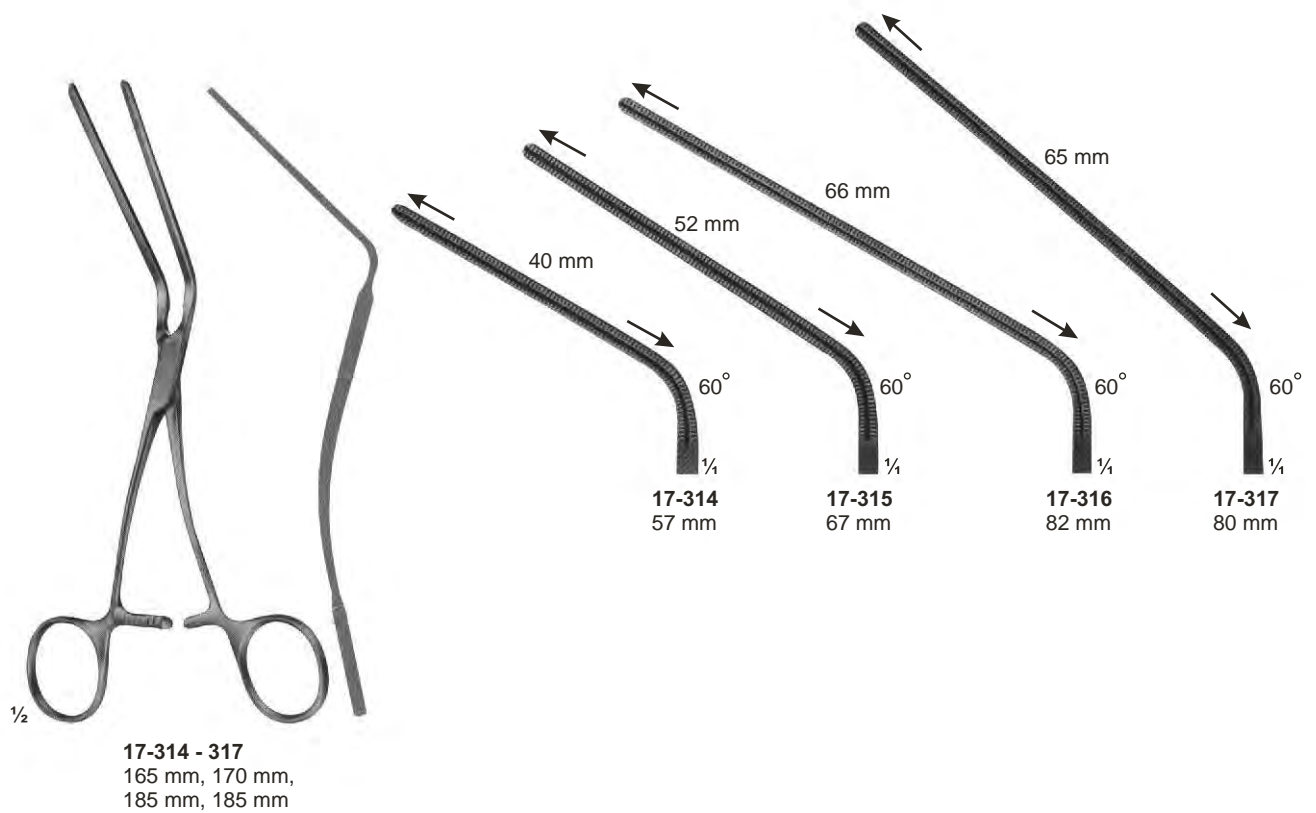
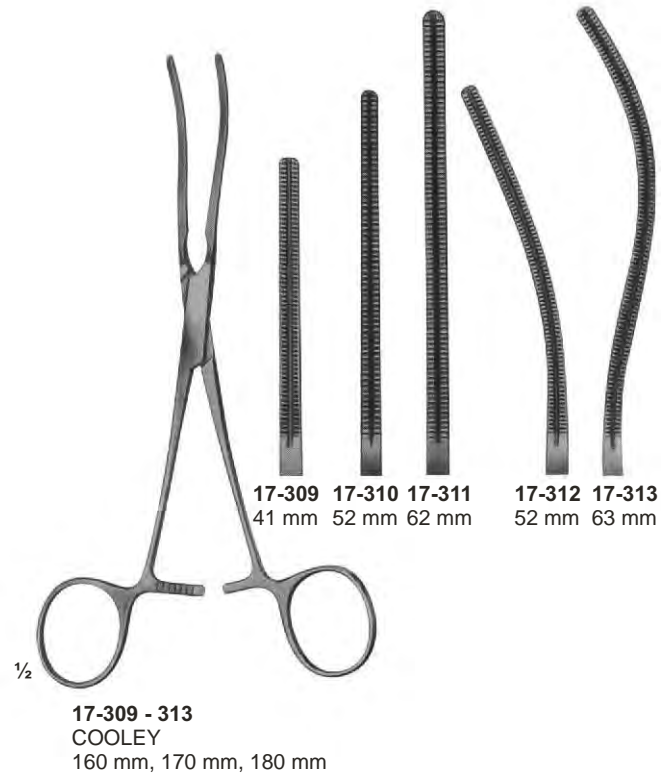
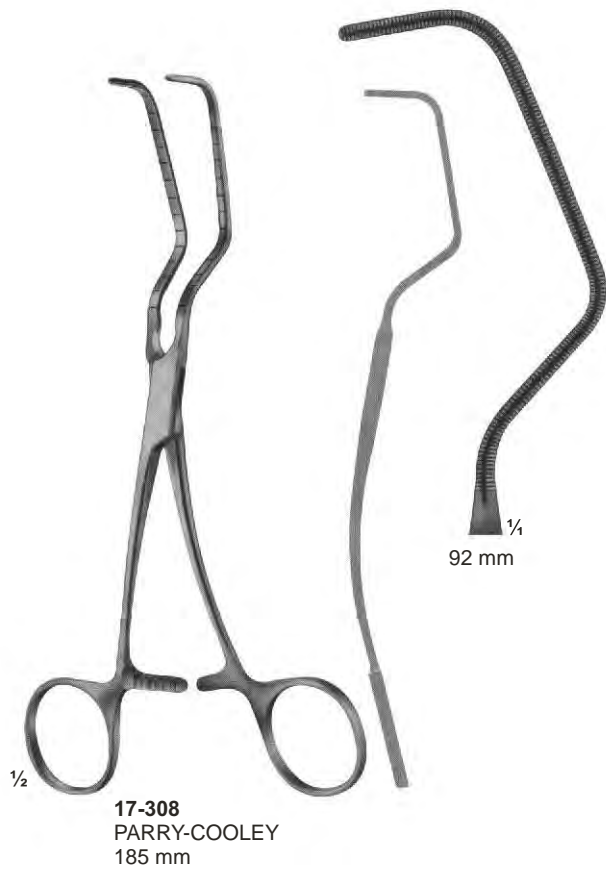



DARDIK			
<b>17-318</b>	150 mm	<b>17-323</b>	170 mm
<b>17-319</b>	150 mm	<b>17-324</b>	170 mm
<b>17-320</b>	150 mm	<b>17-325</b>	170 mm
<b>17-321</b>	145 mm	<b>17-326</b>	160 mm
<b>17-322</b>	130 mm	<b>17-327</b>	135 mm

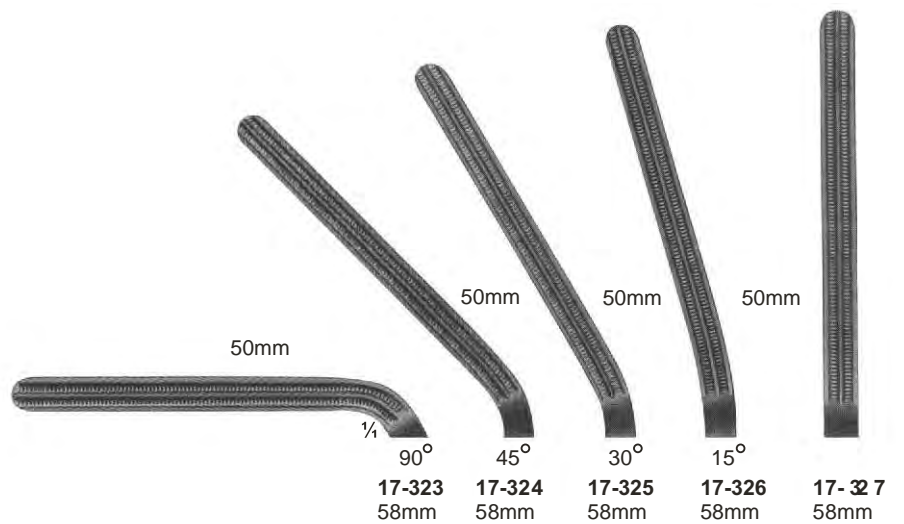
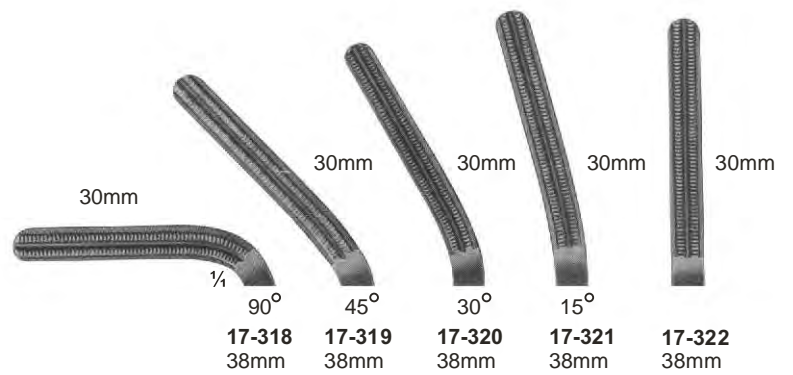

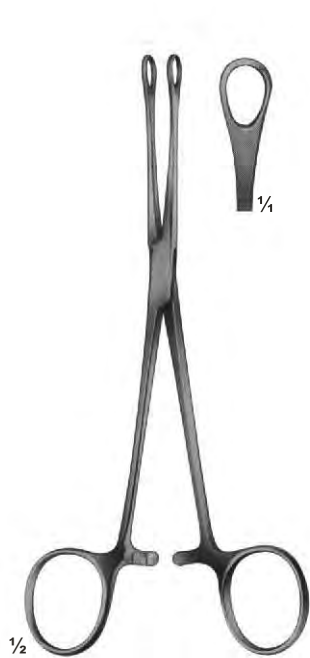

**17-328**  
WILLIAMS  
160 mm



**17-329**  
TUTTLE  
230 mm

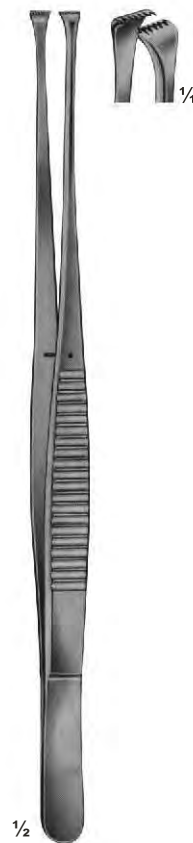

**17-330**  
NELSON  
230 mm



**17-331**  
DUVAL  
230 mm

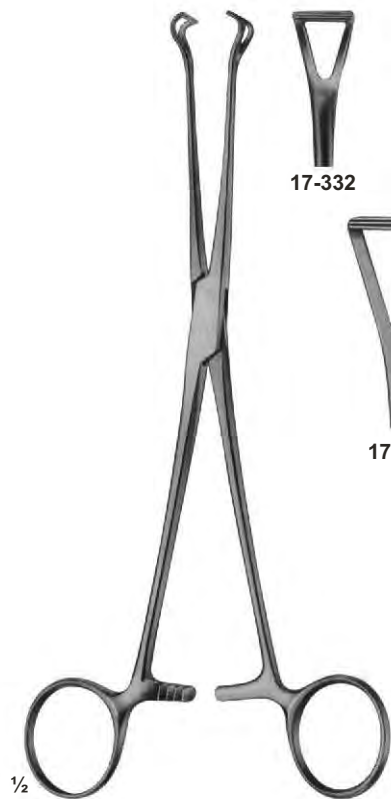

**BABCOCK**  
**17-332** 170 mm  
**17-333** 215 mm  
**17-334** 220 mm

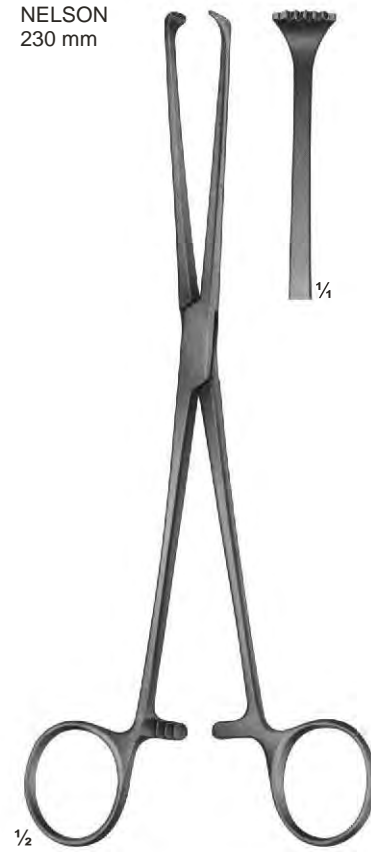

**17-335**  
ALLIS  
220 mm

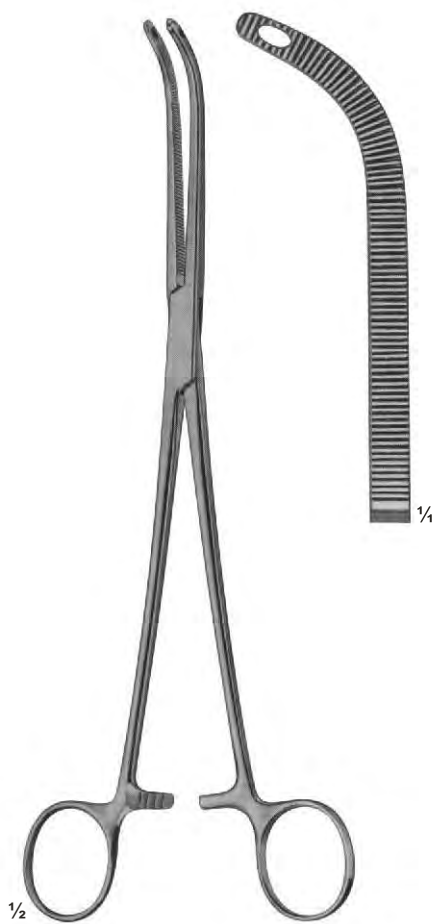

**17-336**  
FINOCHIETTO  
245 mm



**17-337 - 338**  
SEMB  
244 mm

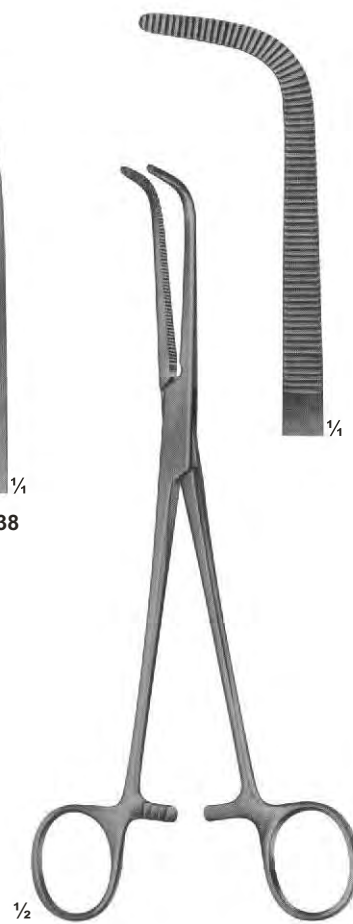

**17-339**  
WIKSTROEM  
205 mm



**17-340**  
MIXTER  
230 mm



**17-341 - 342**  
MIXTER



**17-343**  
HOPFNER  
160 mm

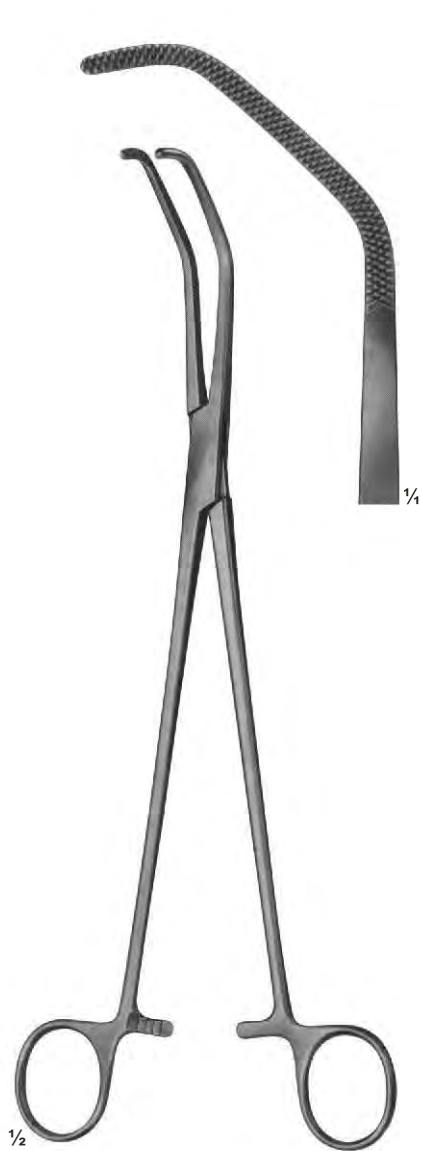

**17-344**  
SATINSKY  
265 mm



**17-345**  
SATINSKY  
265 mm

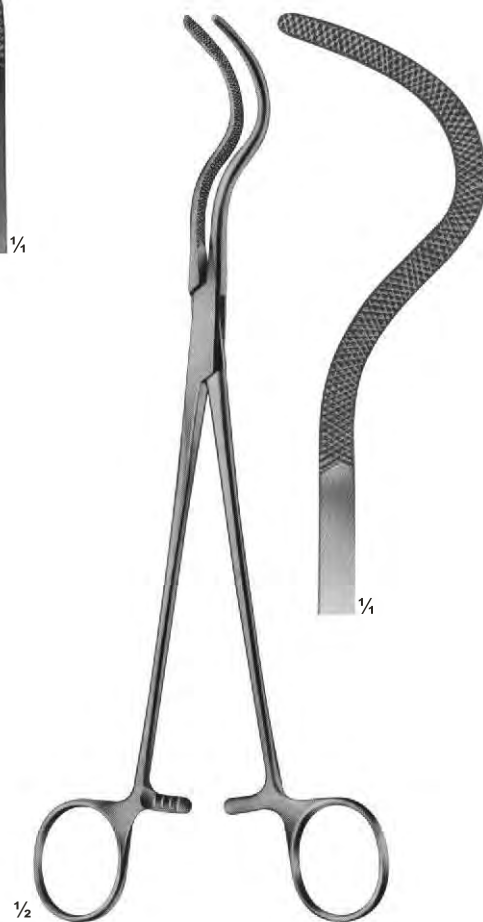

**17-346**  
HARKEN  
240 mm



**17-347**  
PERTUISET  
Carotid Clamp  
90 mm

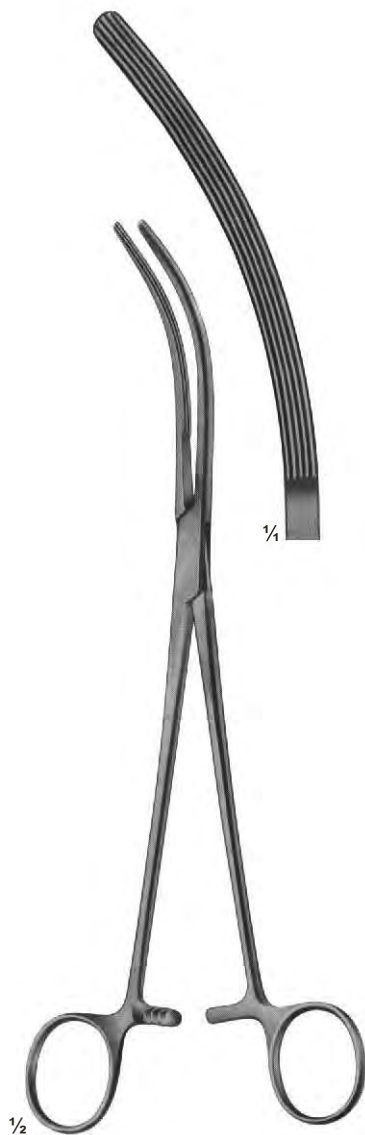

**17-348**  
CRAFOORD-SELLORS  
240 mm



**17-349 - 350**  
CRAFOORD  
240 mm



**17-351**  
PRICE THOMAS  
225 mm



**17-352**  
jaws with pins

**17-353**  
jaws with pins

**17-352 - 353**  
PRICE THOMAS  
225 mm



**17-354**  
SCHUMACHER  
Sternum shears  
210 mm



**17-355**  
LEBSCHKE  
Sternum chisel  
200 mm



**17-356**  
230 mm



**17-357**  
COLLIN  
195 mm



**17-358**  
GLUCK  
190 mm



**17-359**  
GLUCK  
190 mm



**17-360**  
BRUNNER  
Universal Pattern  
340 mm



**17-361**  
GIERTZ-STILLE  
250 mm

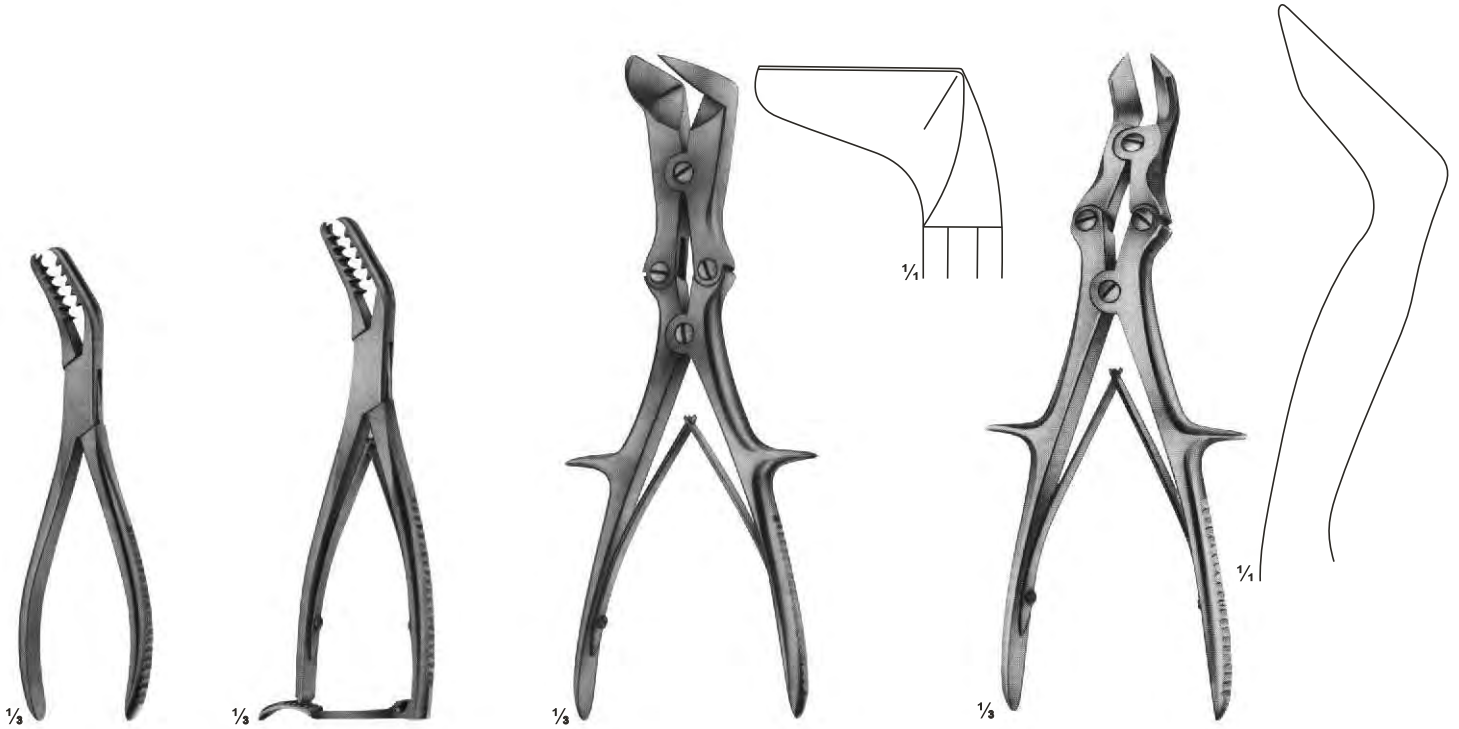

**17-362**  
SEMB  
Rib-and Bone  
Holding forceps  
190 mm

**17-363**  
SEMB  
Rib-and Bone  
Holding forceps  
190 mm

**17-364**  
LISTON-STILLE  
265 mm

**17-365**  
LISTON-KEY-HORSLEY  
255 mm

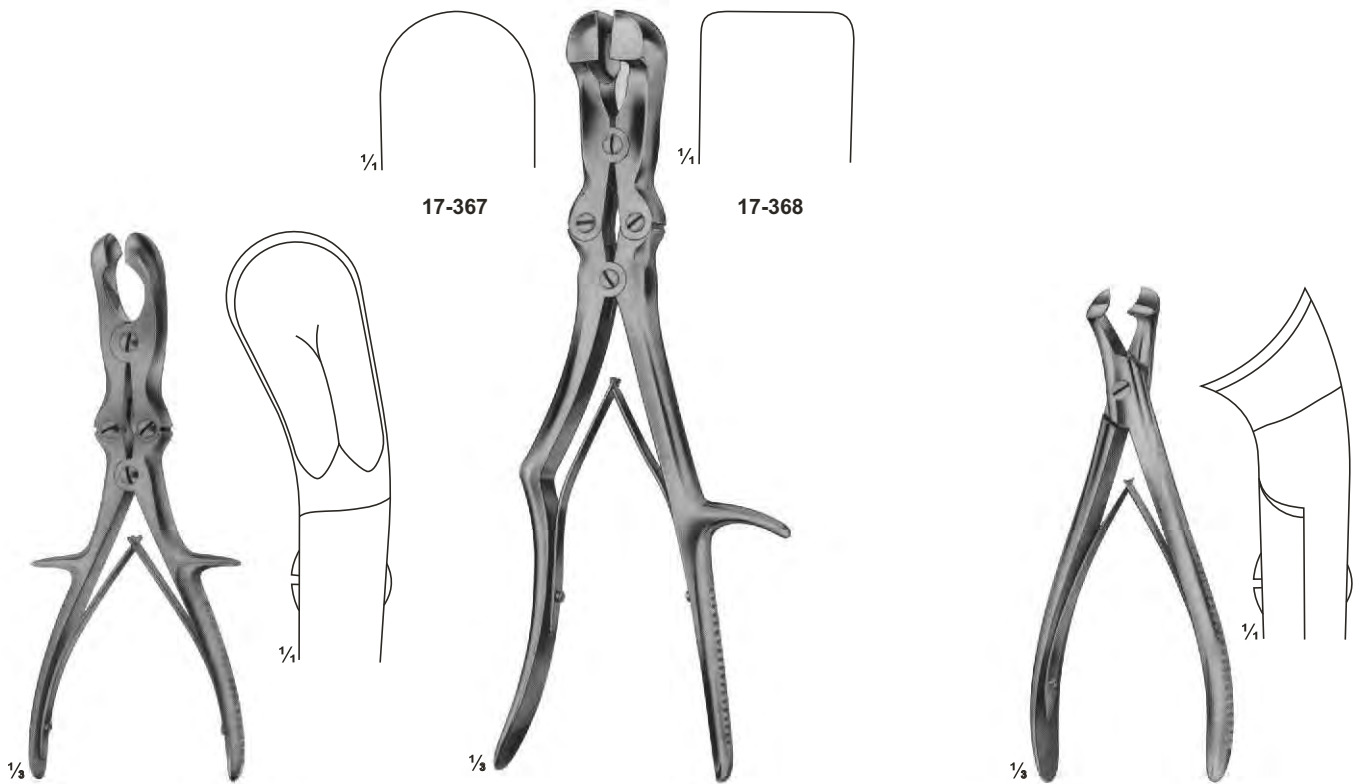

**17-366**  
SEME  
Rib Rongeur to shorten  
the rib stumps  
240 mm

**17-367-368**  
SAUERDRUCH-CORYLLOS  
Rib rongeurs to shortn  
the rib stumbes  
310 mm

**17-369**  
MARKWALDER  
Rib Rongeur to Round  
the rib stumps  
190 mm

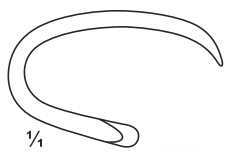

17-370

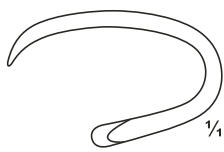

17-371



17-372



17-373

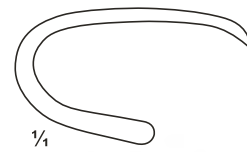

17-374

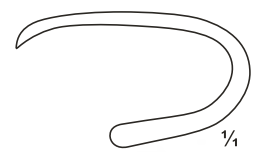

17-375



**17-370 - 371**  
DOYEN  
for children  
175 mm

**17-372 - 373**  
DOYEN  
for adults  
175 mm

**17-374 - 375**  
DOYEN  
240 mm

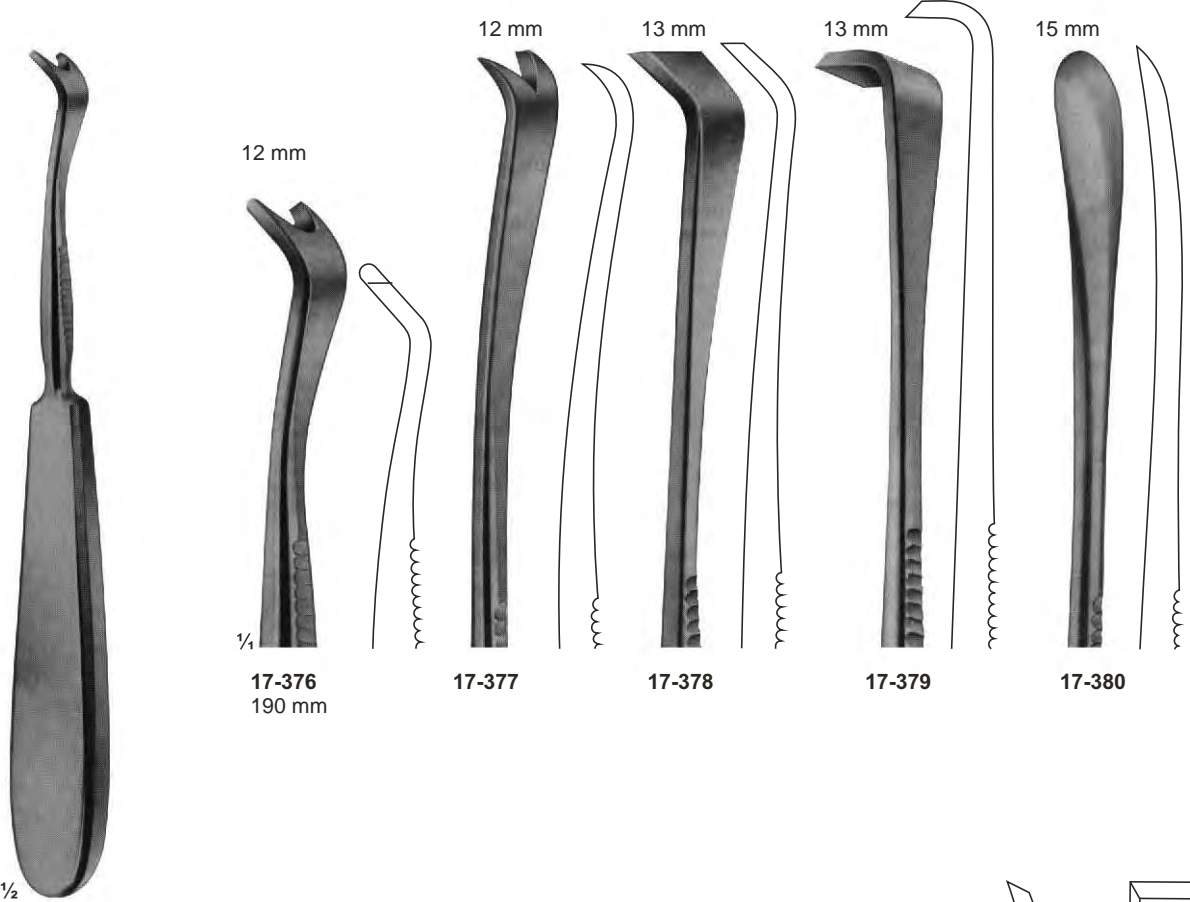

1/2  
**17-376 - 380**  
 SEMB  
 230 mm

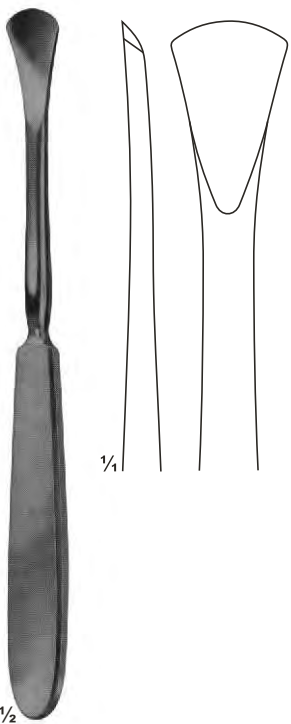

1/2  
**17-381**  
 LANGENBECK  
 190 mm

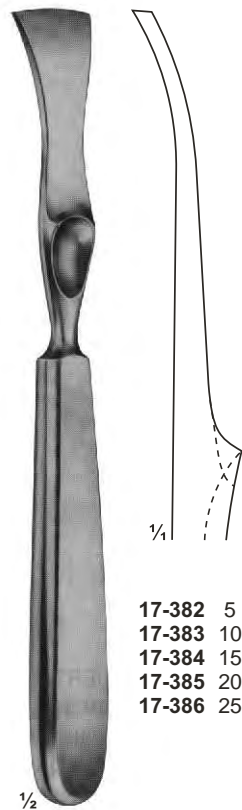

**17-382** 5 mm  
**17-383** 10 mm  
**17-384** 15 mm  
**17-385** 20 mm  
**17-386** 25 mm

1/2  
**17-382 - 386**  
 LAMBOTTE  
 215 mm

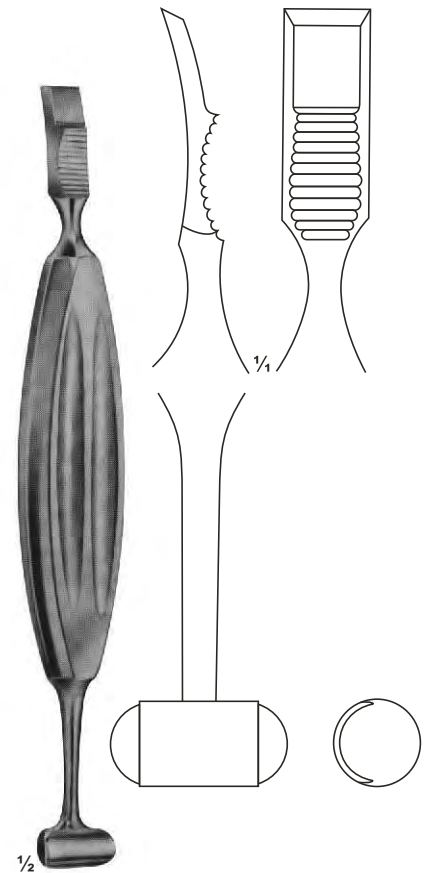

1/2  
**17-387**  
 ALEXANDER  
 210 mm

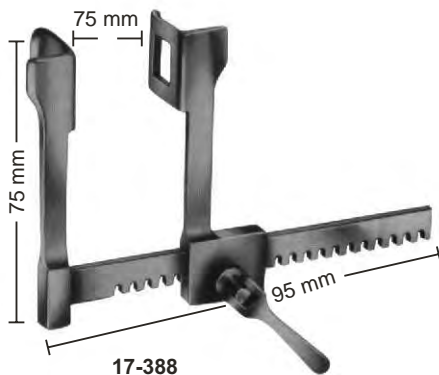

**17-388**  
FINOCHIETTO  
18X21 mm

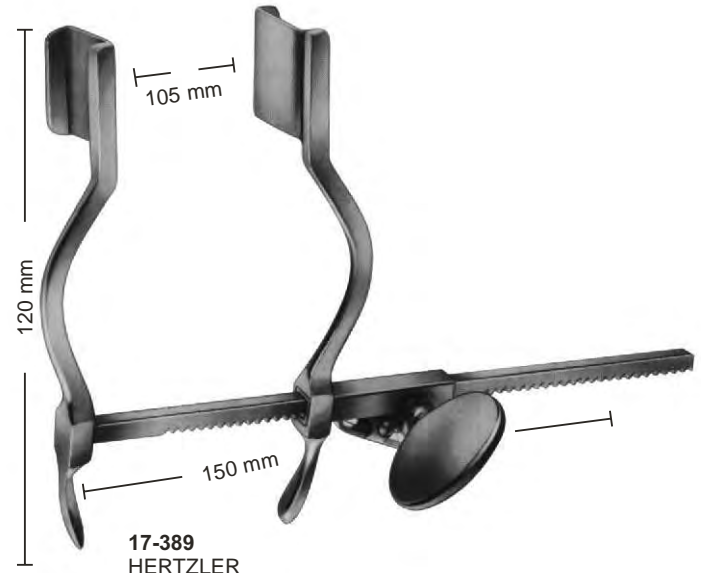

**17-389**  
HERTZLER  
20X25 mm

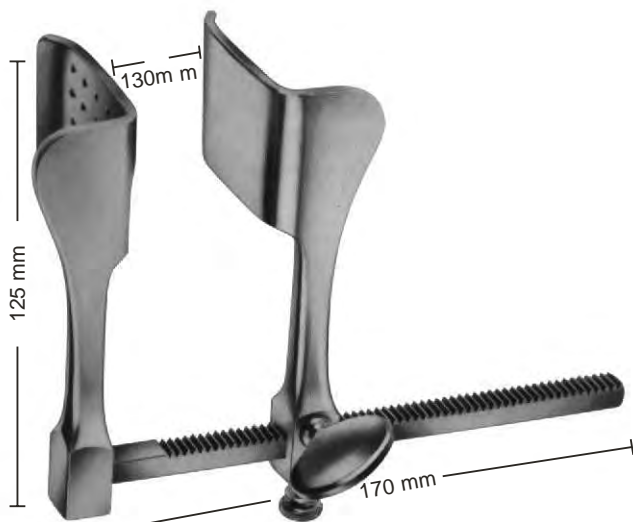

**17-390**  
TUFFIER  
Blades  
43X53 mm

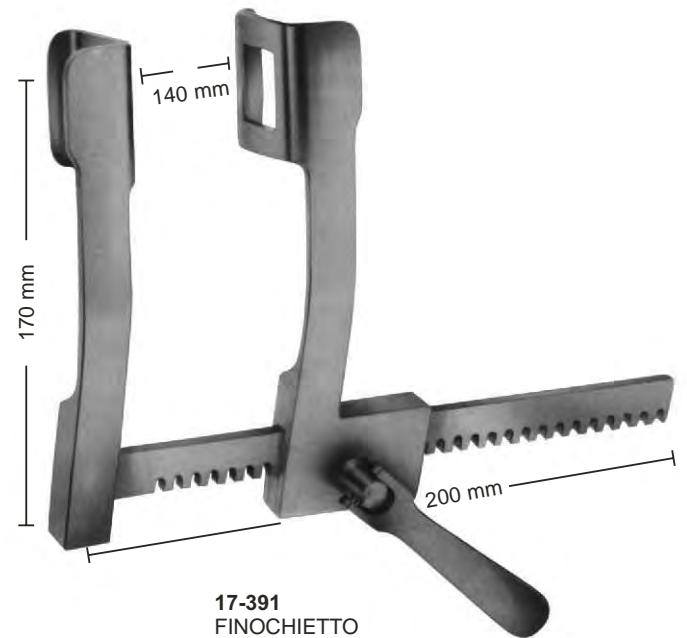

**17-391**  
FINOCHIETTO  
Blades  
36X45 mm

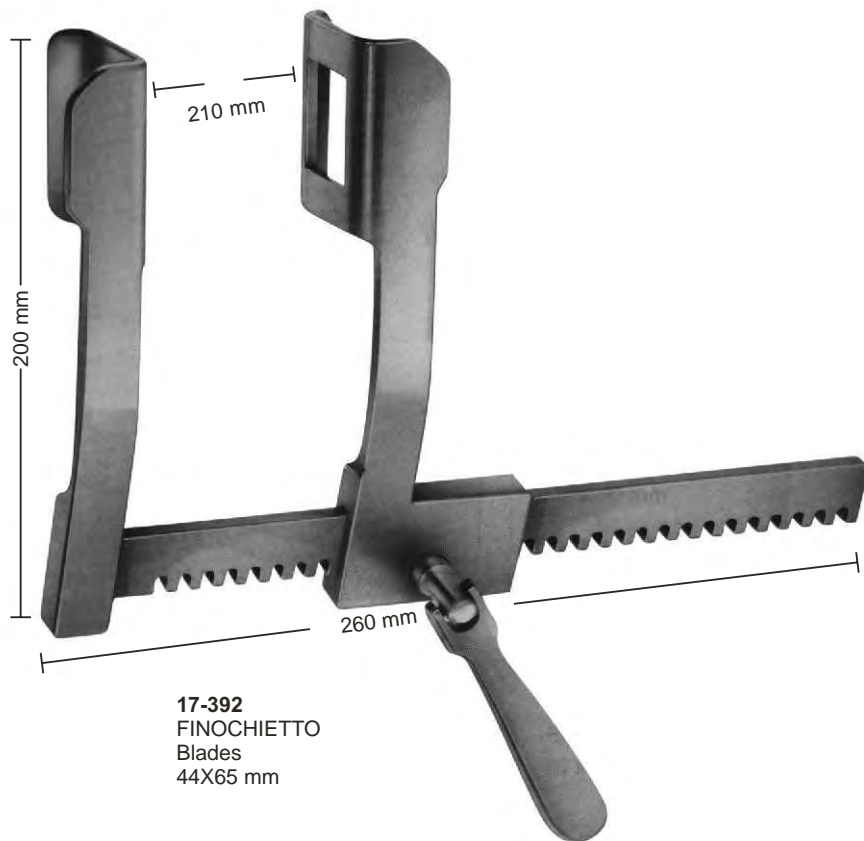

**17-392**  
FINOCHIETTO  
Blades  
44X65 mm

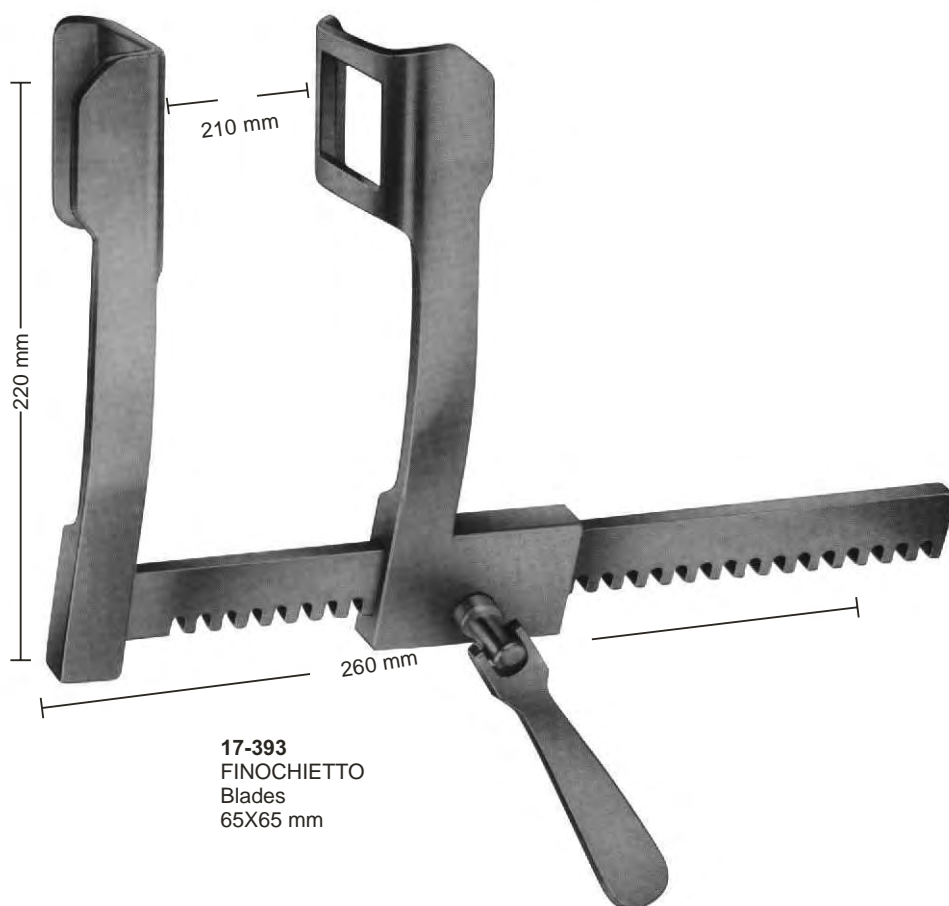

**17-393**  
FINOCHIETTO  
Blades  
65X65 mm

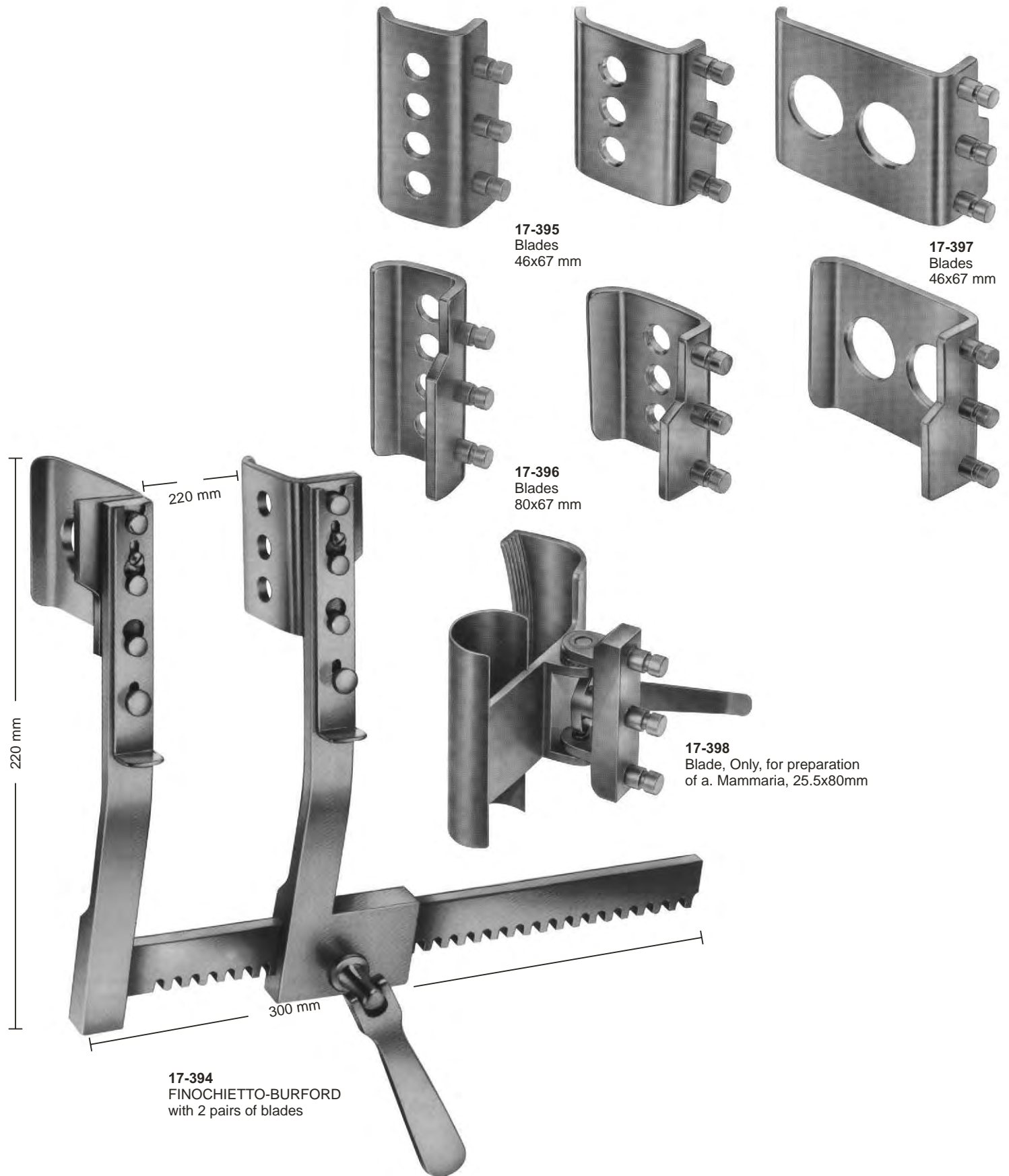

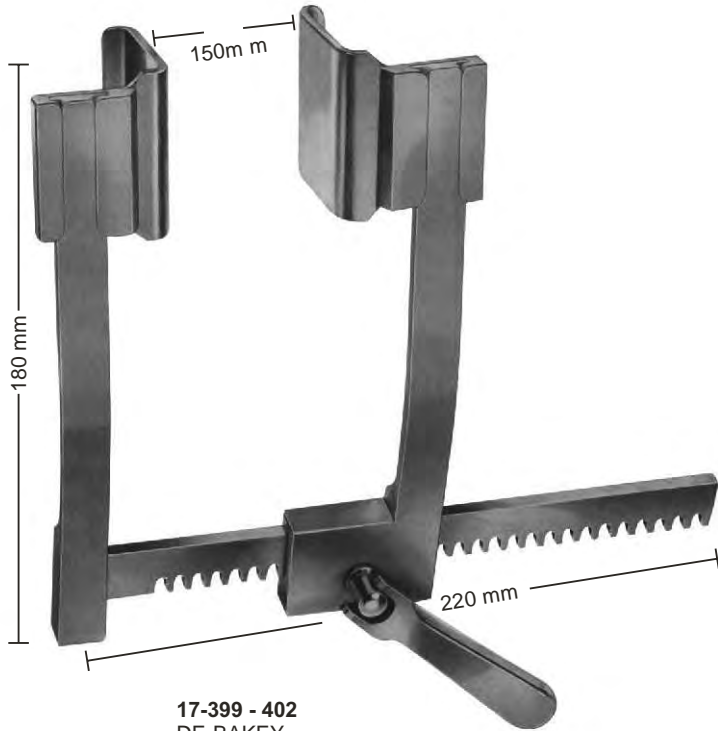

**17-399 - 402**  
DE-BAKEY  
with 3 pairs of blades

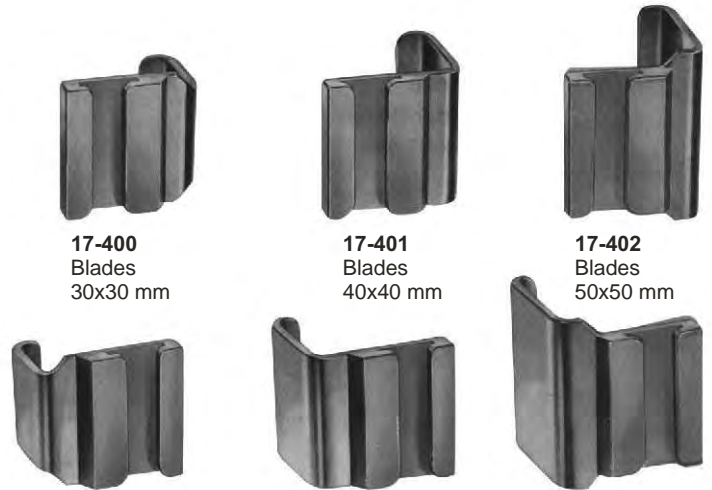

**17-400**  
Blades  
30x30 mm

**17-401**  
Blades  
40x40 mm

**17-402**  
Blades  
50x50 mm

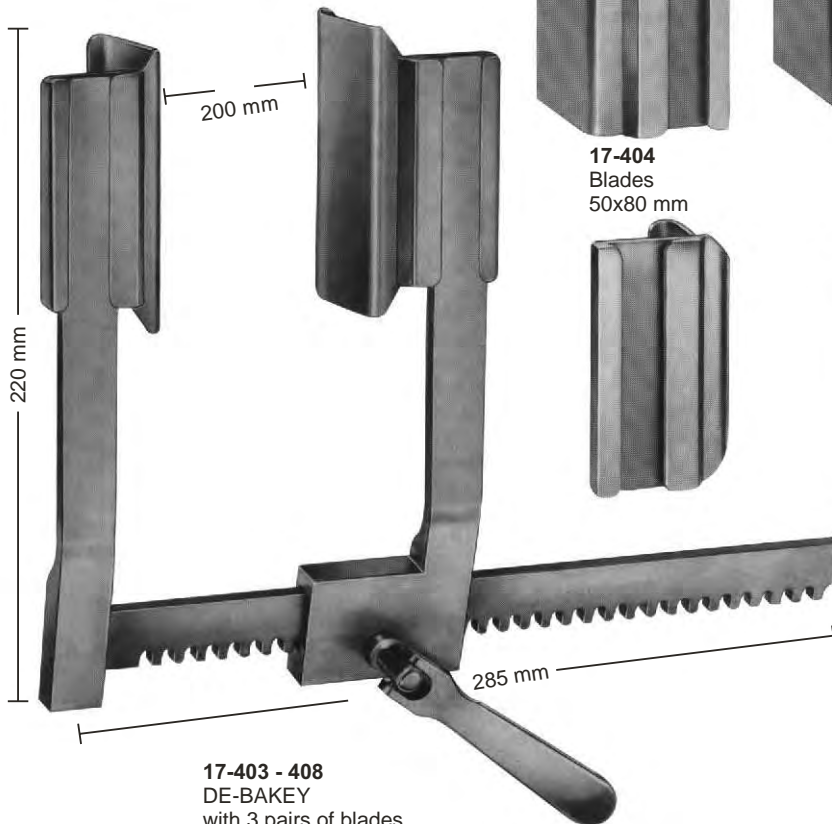

**17-403 - 408**  
DE-BAKEY  
with 3 pairs of blades

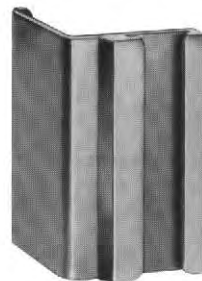

**17-404**  
Blades  
50x80 mm

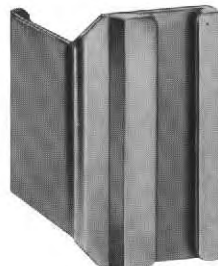

**17-405**  
Blades  
80x60 mm

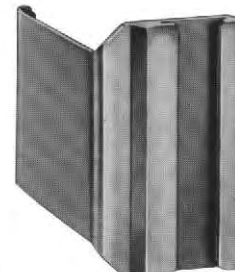

**17-406**  
Blades  
50x80 mm



**17-407**  
Blades  
40x100 mm



**17-408**  
Sternotomy Blades  
50x660 mm

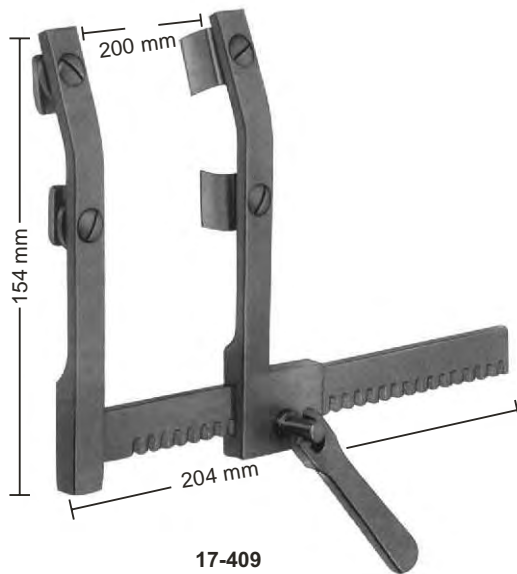

**17-409**  
**MORSE**  
Sternotomy spreader  
for children, with moveable  
double, each blade  
12x20 mm

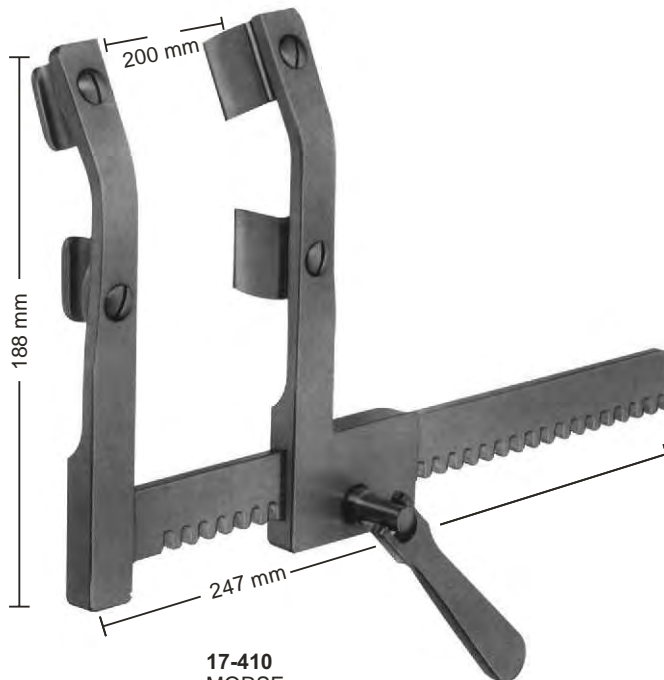

**17-410**  
**MORSE**  
Sternotomy spreader  
for adults, with moveable  
double, each blade  
19x19 mm

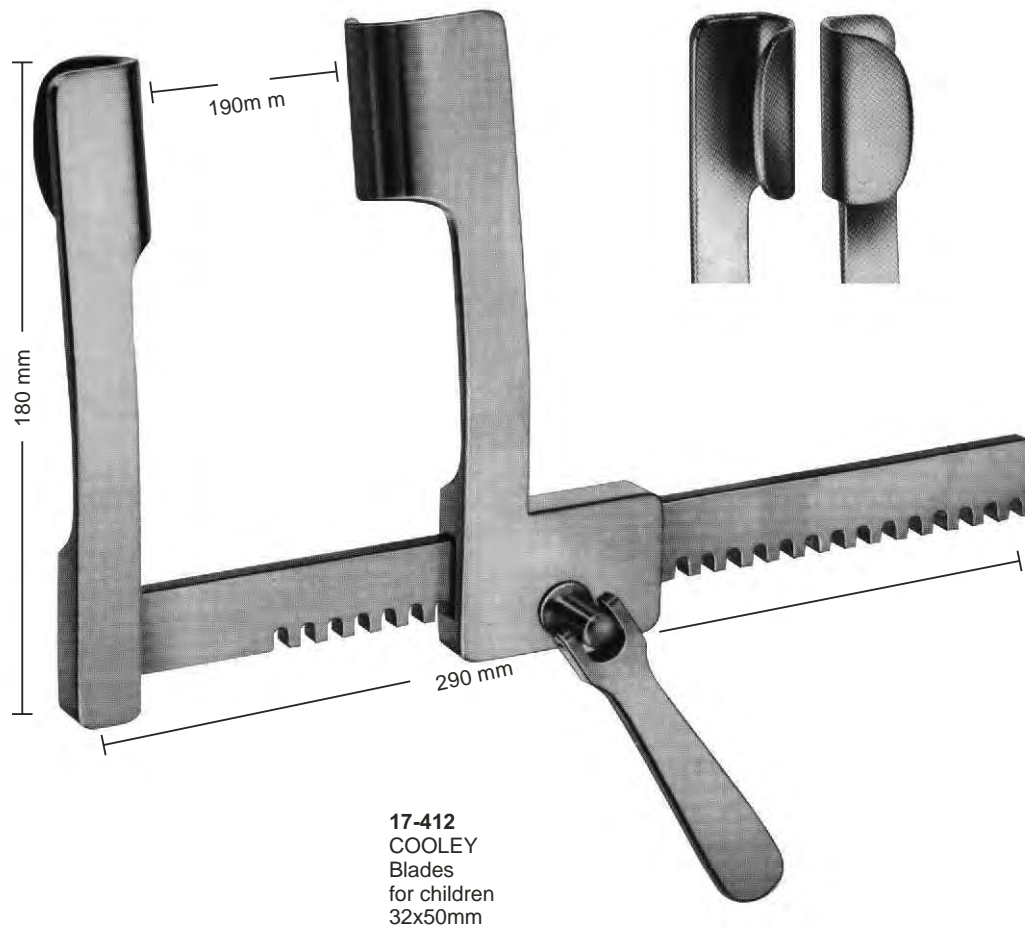
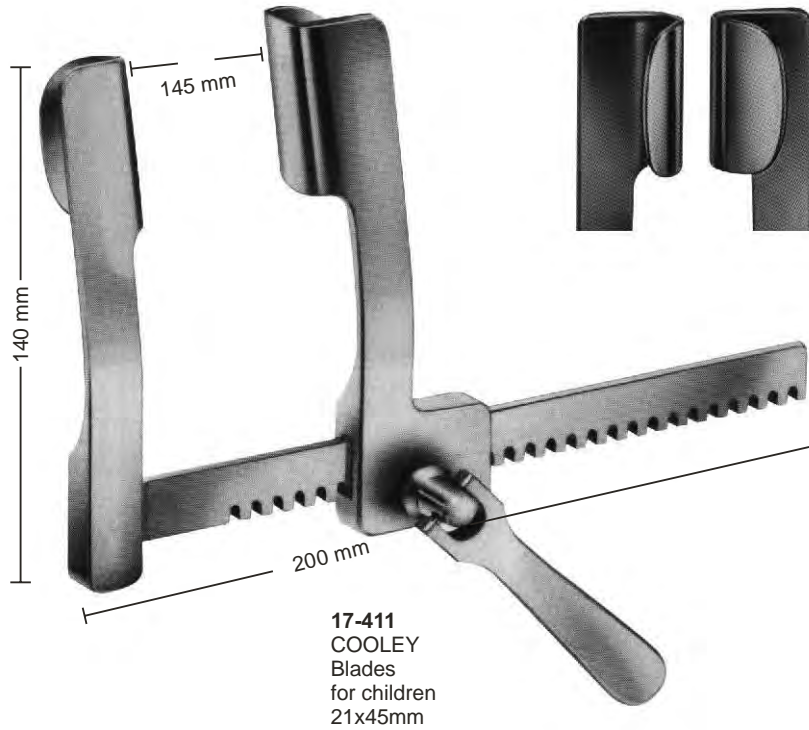



**17-414**  
Blades  
75x75 mm



**17-415**  
Blades  
42x65 mm

Blades with Ball Snap System  
Delivery: in Pairs

**17-413 - 415**  
Thoraxsperrer (Mercedes-Sperrer)  
complete consisting of:  
**17-413** Retractor only  
**17-414** 1 Pair of blades 42x65 mm  
**17-415** 1 Pair of blades 75x75 mm



**17-416**  
SELLORS  
Rib spreader-and contractor  
with swivel blades  
200 mm



**17-417**  
BAILEY  
150 mm



**17-418**  
for children

**17-419**  
for children

**17-418 - 419**  
BAILEY  
200 mm

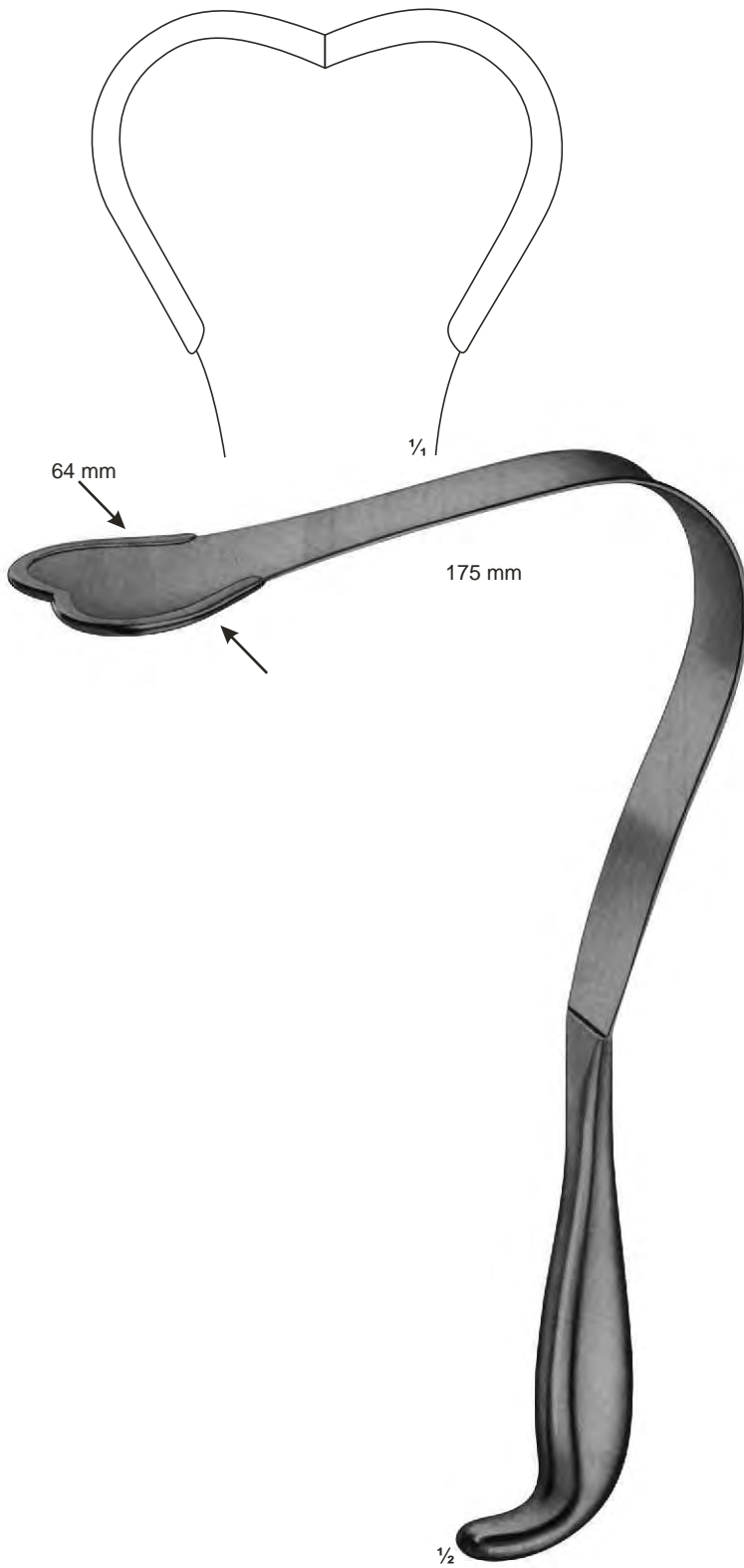

**17-420**  
HARRINGTON-PEMBERTON  
federnd/flexible  
295 mm

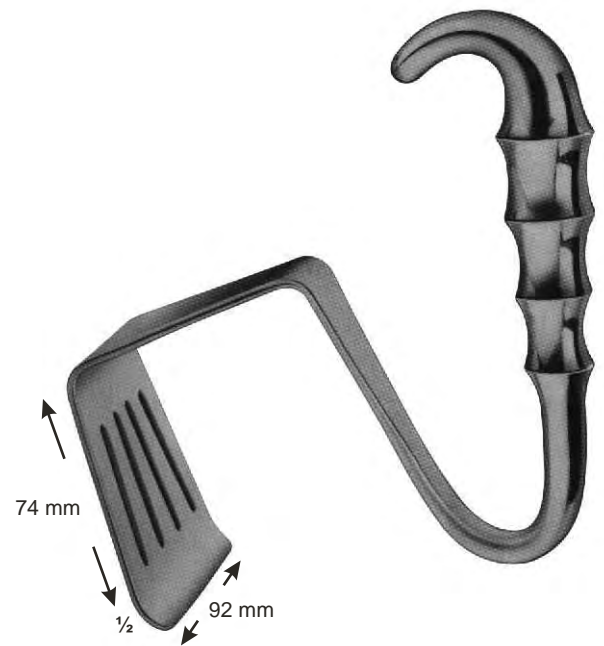

**17-421**  
DAVIDSON  
Scalpel haken



**17-422**  
ALLISON  
255 mm



**17-423**  
ALLISON  
320 mm



**17-424**  
DE BAKEY  
With central bore,  
3.0mm diam.  
with lateral slots  
275 mm



**17-425**  
YANKAUER  
With central bore,  
2.0mm diam.  
285 mm

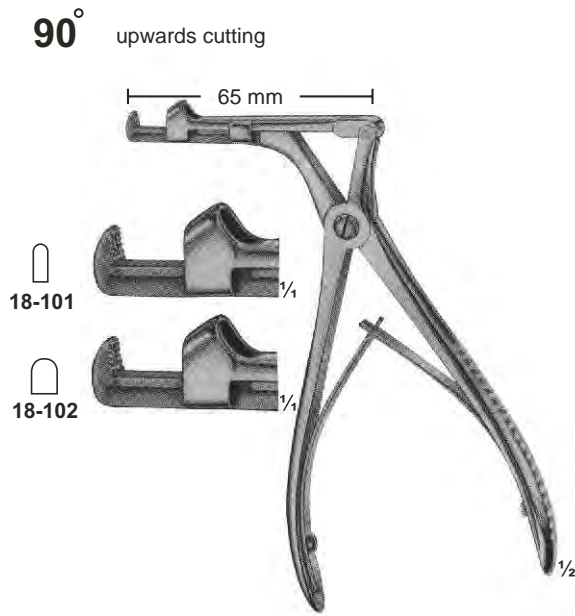
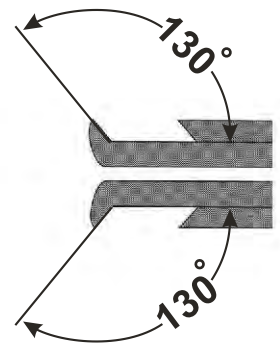
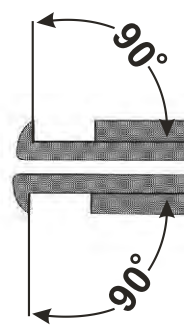
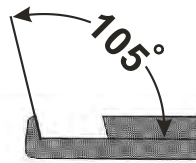

**18-101 - 102**  
CITELLI  
2 mm, 3,5 mm

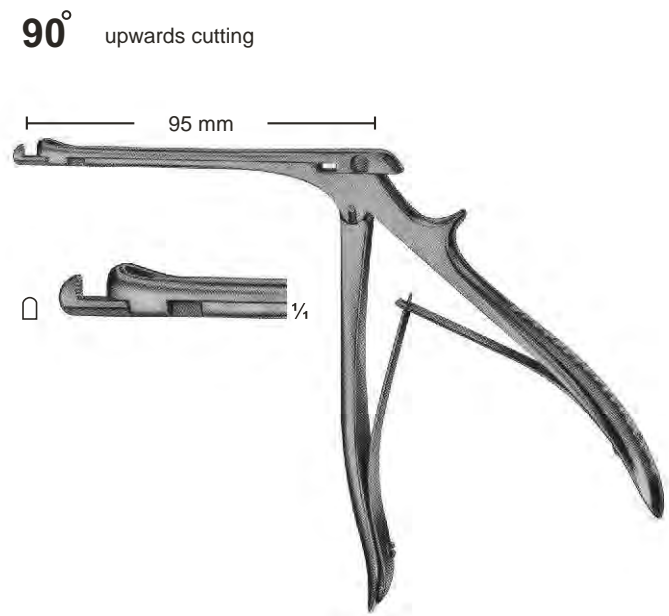

**18-103**  
CITELLI- BEYER  
1,8 mm



90° upwards cutting

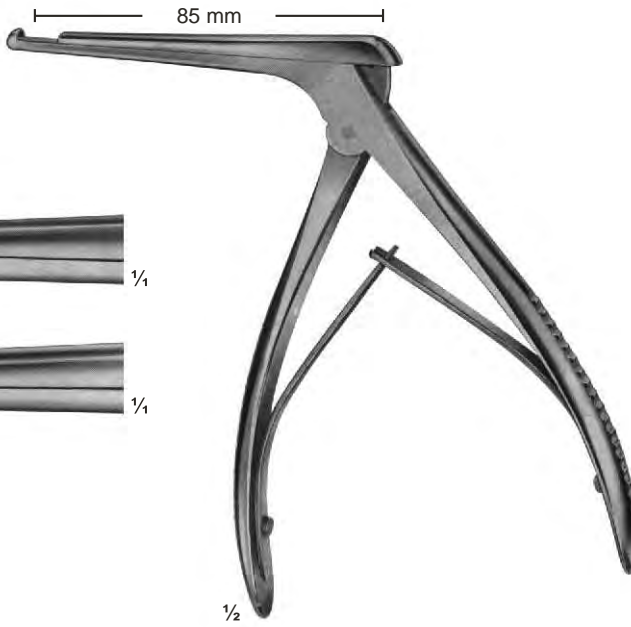

18-104  
4 mm



18-105  
5 mm



18-104 - 105  
KERRISON

90° upwards cutting

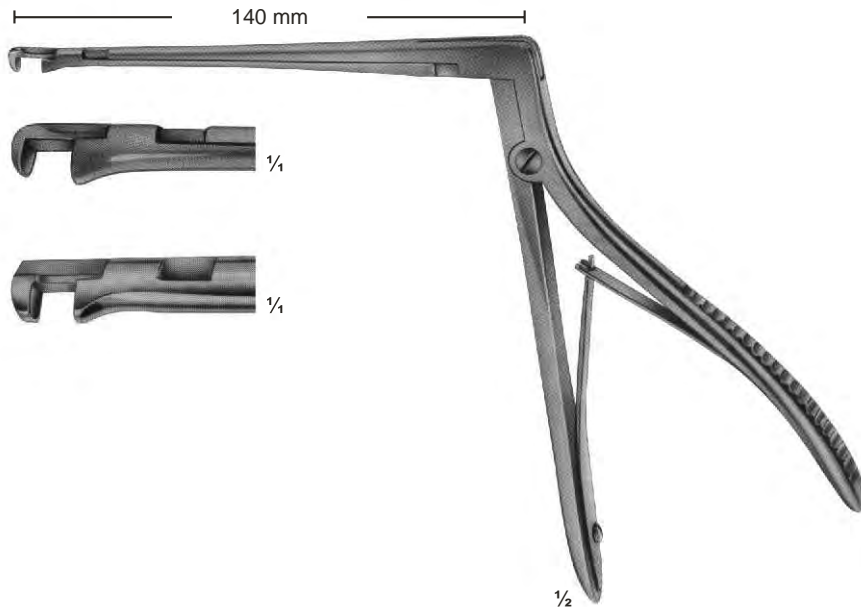

18-106  
3,3 mm



18-107  
4,0 mm



18-106 - 107  
HAJEK-KOFLER



## 130° upwards cutting

**18-108**  
1 mm

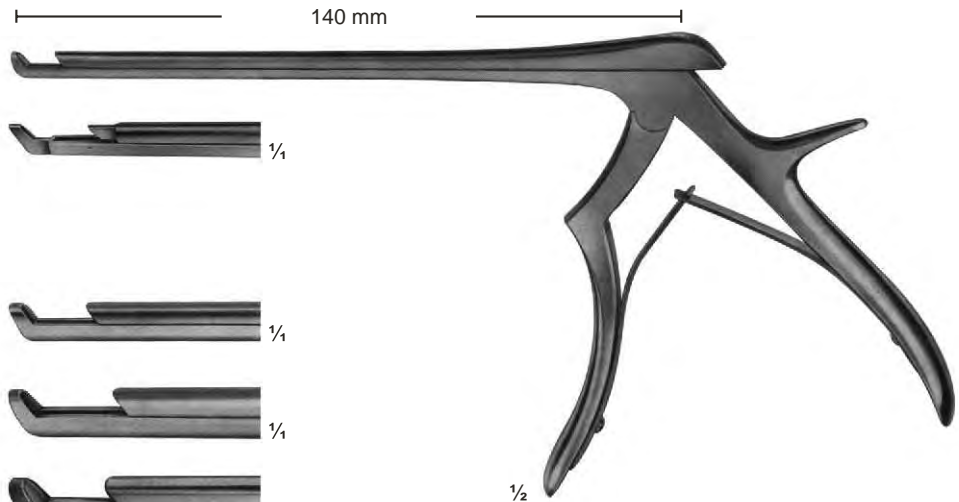

**18-109**  
2 mm



**18-110**  
3 mm



**18-111**  
4 mm



**18-112**  
5 mm



**18-108 - 112**  
KERRISON-JACOBY

## 90° upwards cutting

**18-113**  
1 mm



**18-114**  
2 mm



FERRIS-SMITH-KERRISON

**18-115**  
3 mm



**18-116**  
4 mm



**18-117**  
5 mm

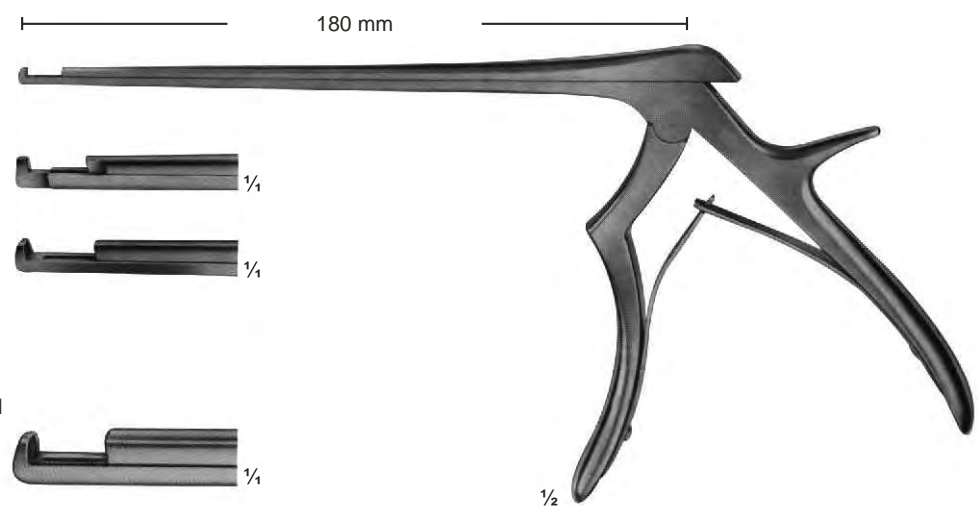

**18-113 - 117**  
KERRISON-JACOBY



Angled positions for rongeurs

**18-118**  
3,0 mm

**18-119**  
3,6 mm

**18-120**  
4,2 mm

**18-121**  
4,8 mm

**18-122**  
5,8 mm

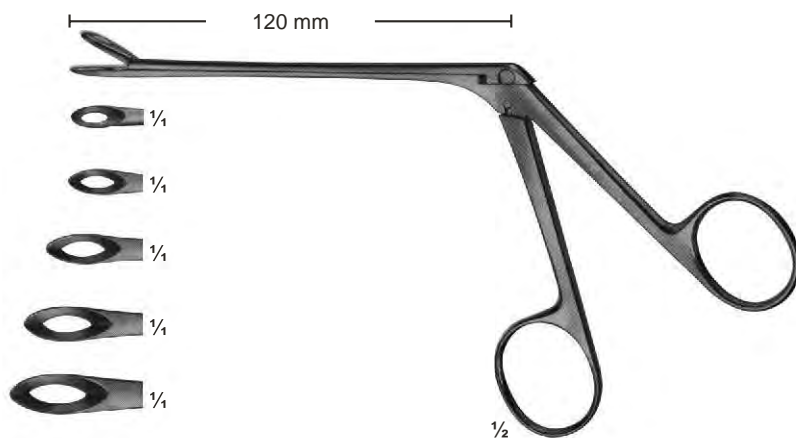

**18-118 - 122**  
WEIL-BLAKESLEY

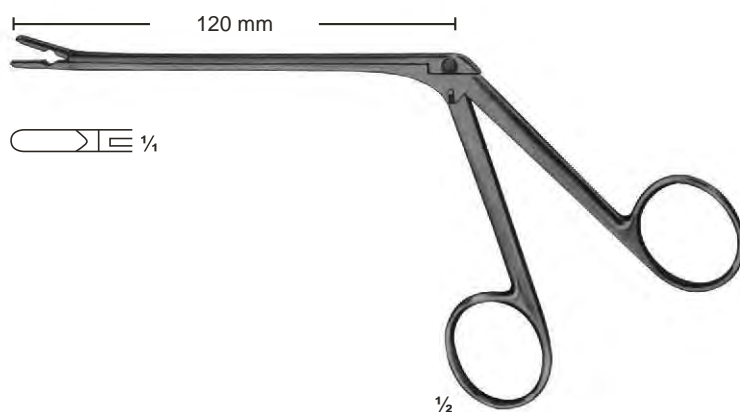

**18-123**  
TAKAHASHI  
3 mm

**130°**

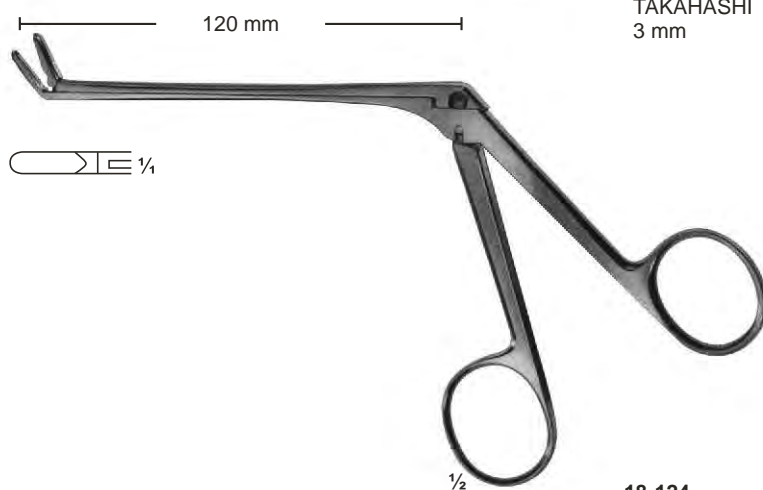

**18-124**  
TAKAHASHI  
3 mm

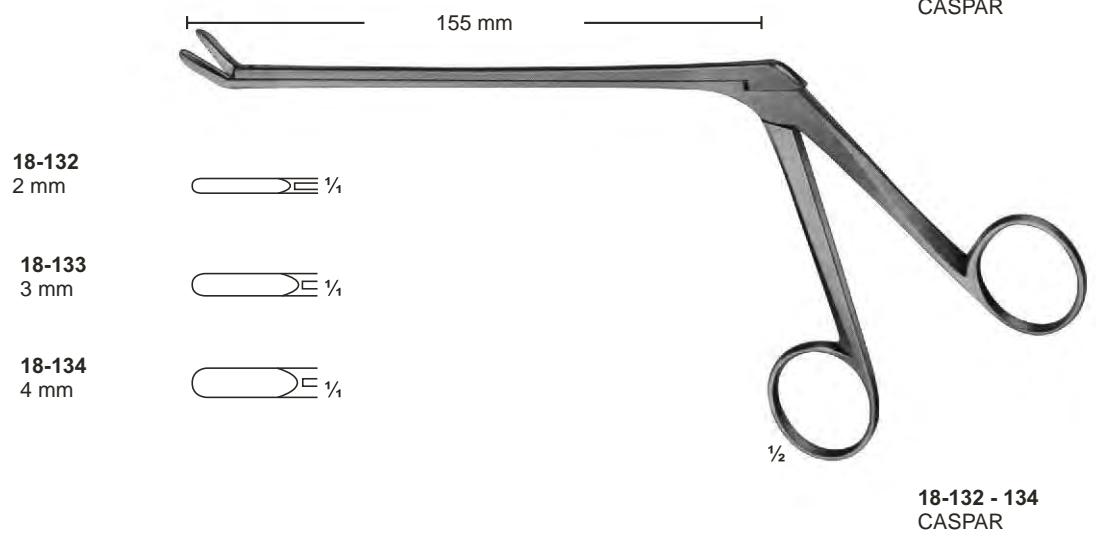
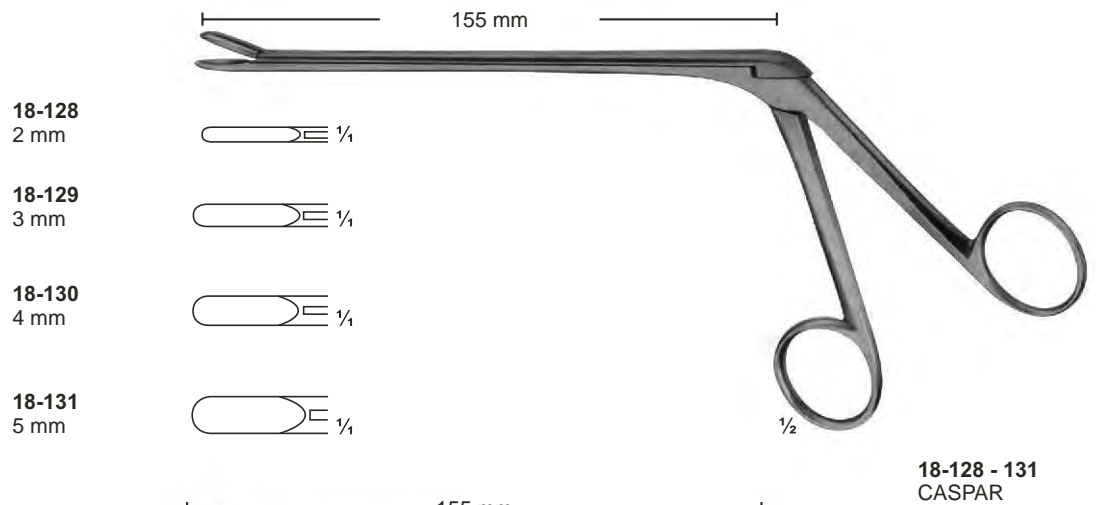
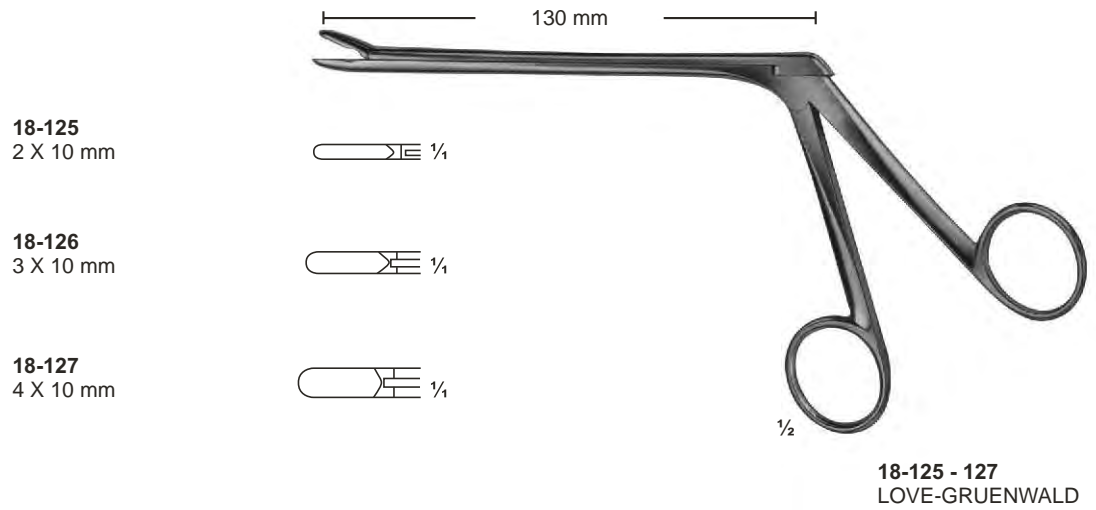

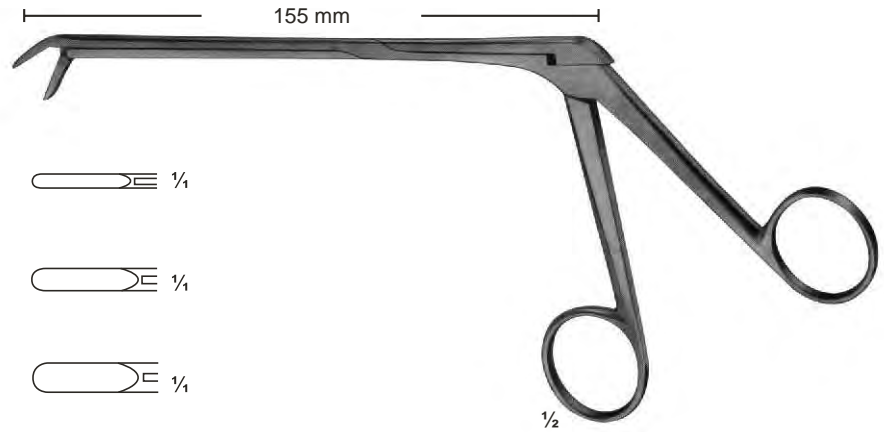

**18-135**  
2 mm

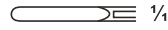

**18-136**  
3 mm



**18-137**  
4 mm



**18-135 - 137**  
CASPAR

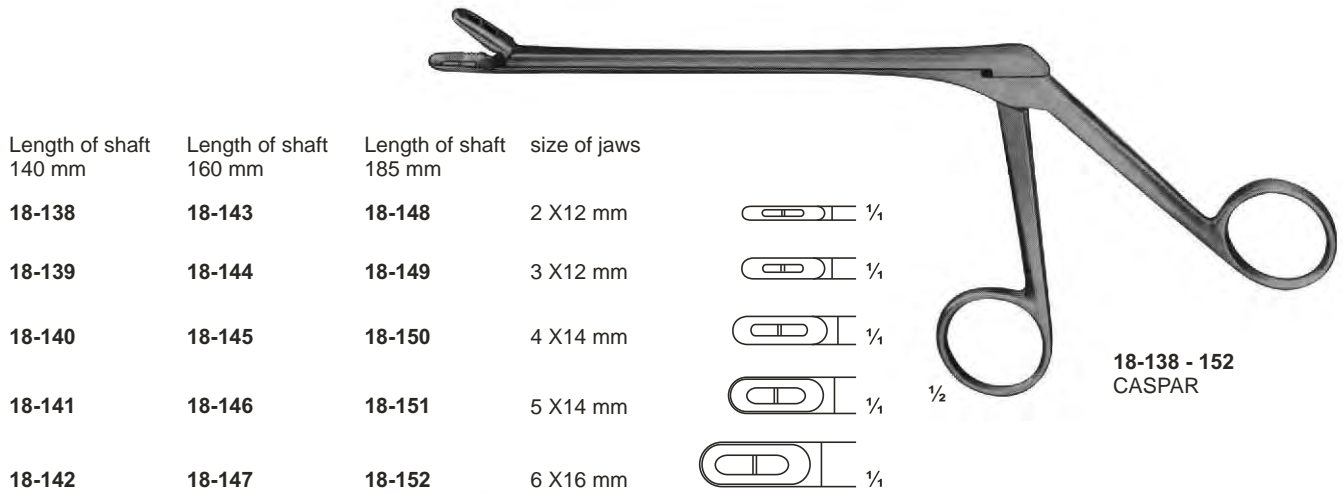

Length of shaft  
140 mm

Length of shaft  
160 mm

Length of shaft  
185 mm

size of jaws

**18-138**

**18-143**

**18-148**

2 X 12 mm



**18-139**

**18-144**

**18-149**

3 X 12 mm



**18-140**

**18-145**

**18-150**

4 X 14 mm



**18-141**

**18-146**

**18-151**

5 X 14 mm



**18-142**

**18-147**

**18-152**

6 X 16 mm



**18-138 - 152**  
CASPAR

Length of shaft  
140 mm

Length of shaft  
160 mm

Length of shaft  
185 mm

size of jaws

**18-153**

**18-156**

**18-159**

3 X 12 mm



**18-154**

**18-157**

**18-160**

4 X 14 mm



**18-155**

**18-158**

**18-161**

5 X 14 mm



**18-153 - 161**  
CASPAR



Length of shaft 140 mm	Length of shaft 160 mm	Length of shaft 185 mm	size of jaws
<b>18-162</b>	<b>18-164</b>	<b>185-166</b>	3 X12 mm
<b>18-163</b>	<b>18-165</b>	<b>18-167</b>	4 X14 mm

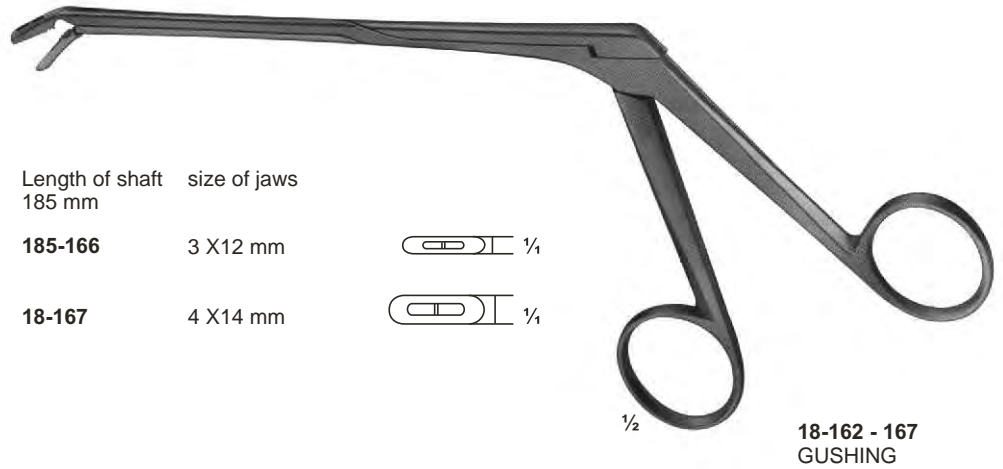

**18-168**  
2 X 10 mm  
GUSHING

**18-169**  
3 X 10 mm  
LOVE-GRUENWALD

**18-170**  
4 X 10 mm  
SPURLING

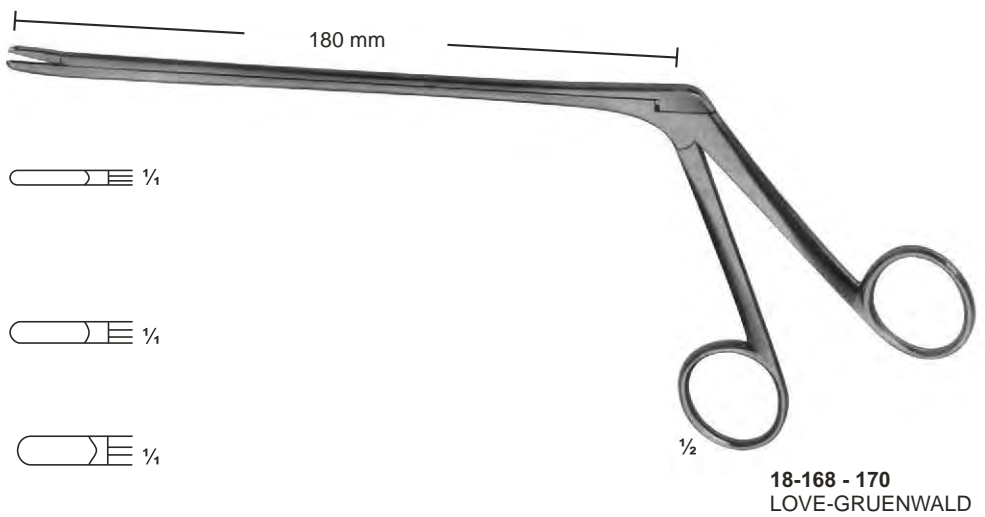

**18-171**  
3 X 10 mm  
LOVE-GRUENWALD

**18-172**  
4 X 10 mm  
SPURLING

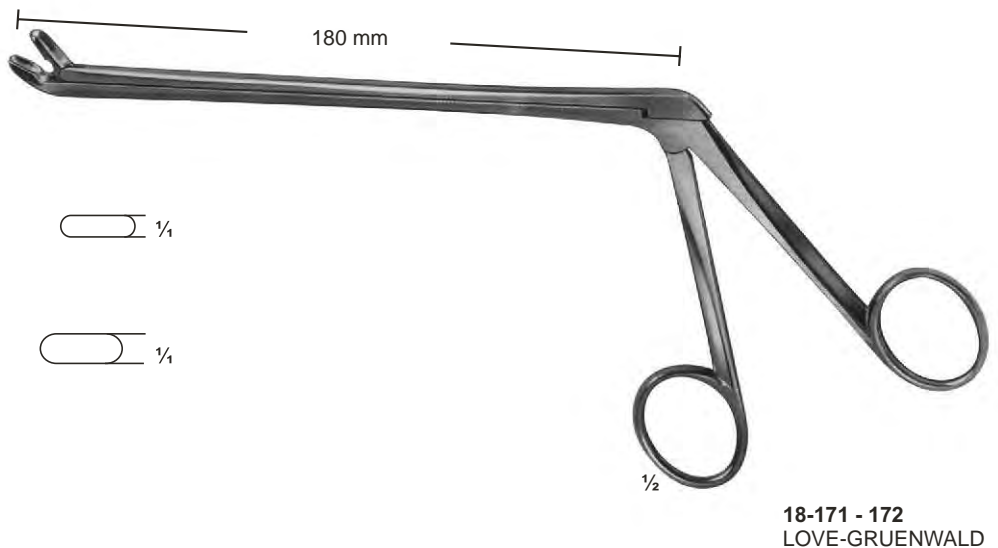



**18-173**  
3 X 10 mm  
LOVE-GRUENWALD

**18-174**  
4 X 10 mm  
SPURLING

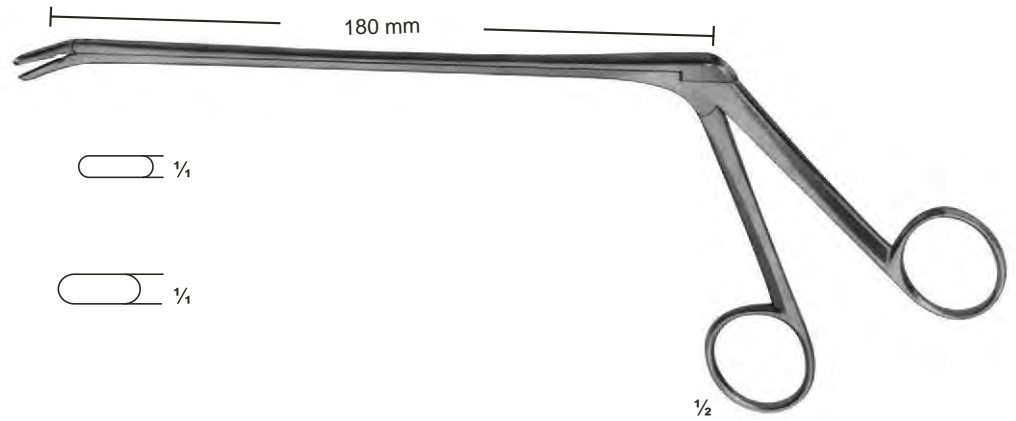

**18-173 - 174**  
LOVE-GRUENWALD

**18-175**  
7 mm

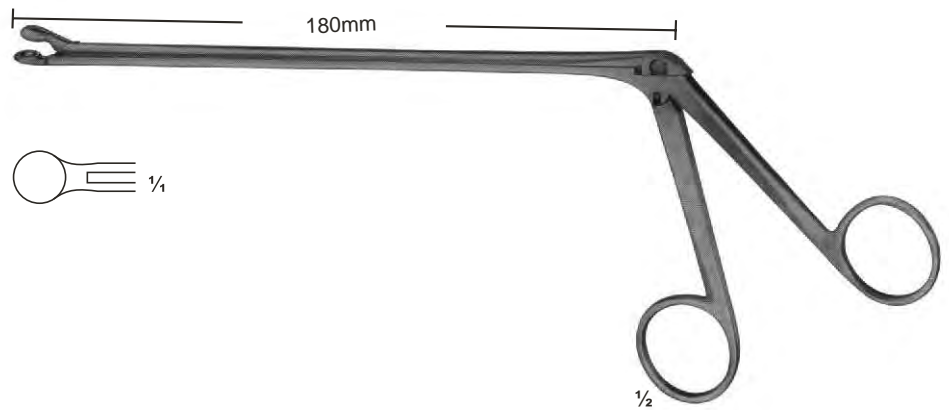

**18-175**  
OLDBERG

**18-176**  
YASARGIL  
2,2 mm

**18-177**  
YASARGIL  
3,5 mm

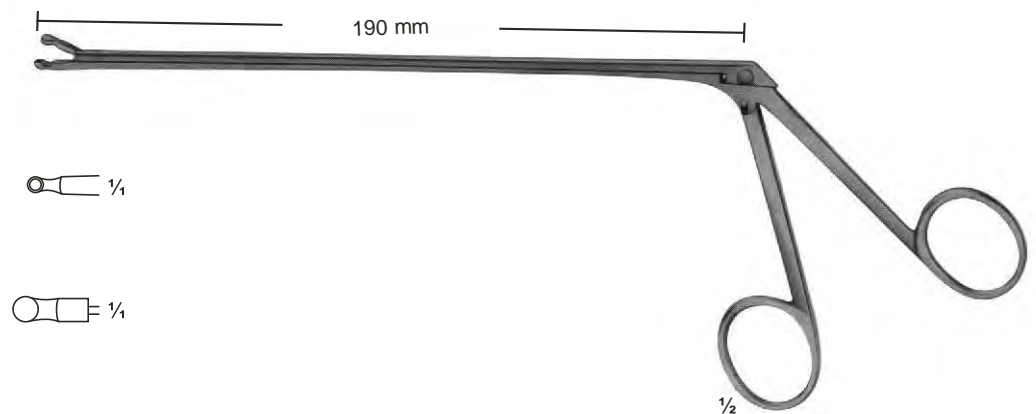

**18-176 - 177**

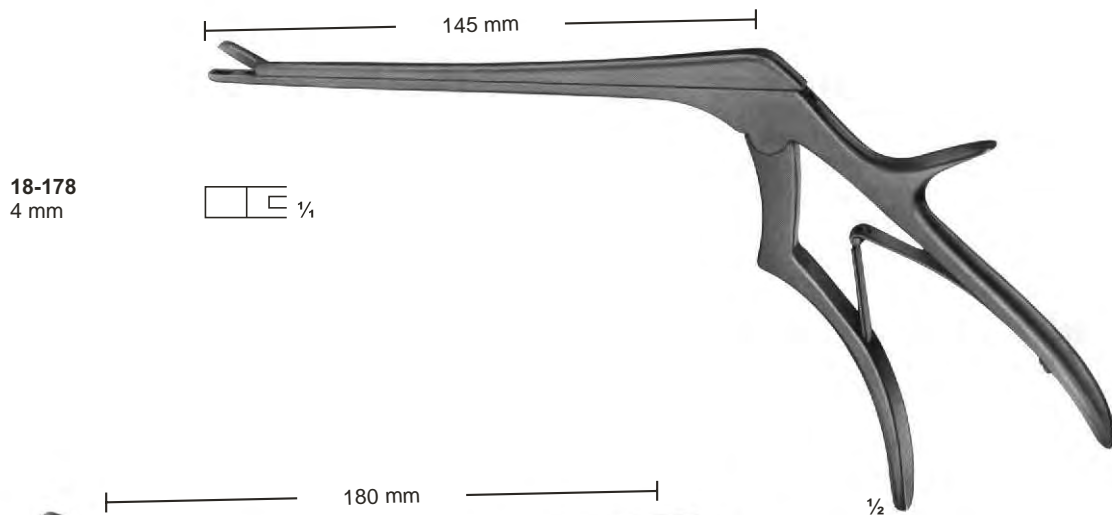

**18-178**  
4 mm



145 mm

1/2

**18-178**  
CASPAR

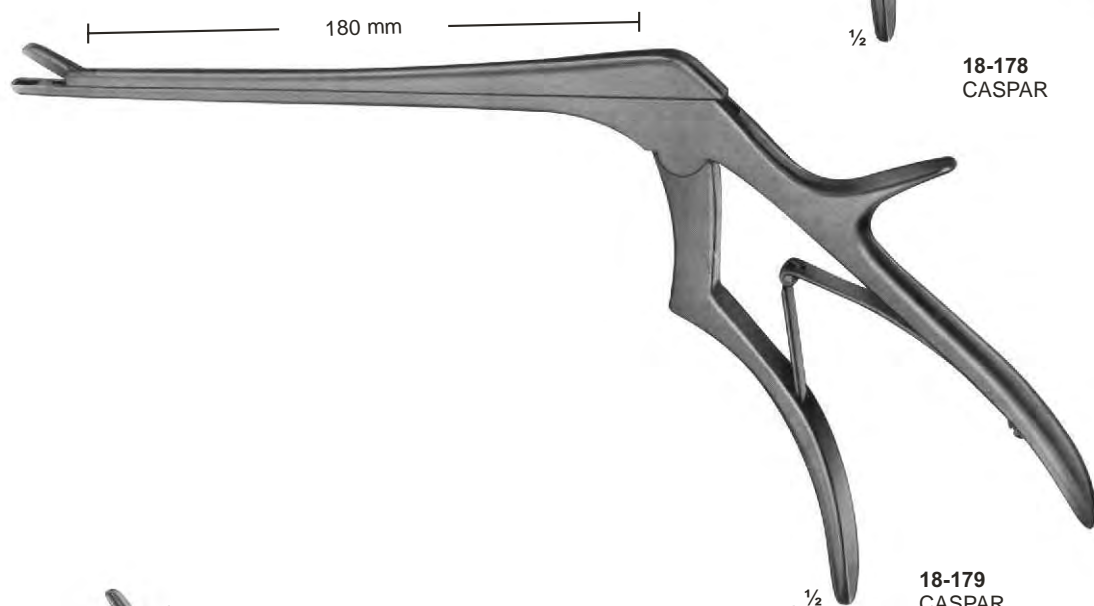

**18-179**  
4 mm



180 mm

**18-179**  
CASPAR

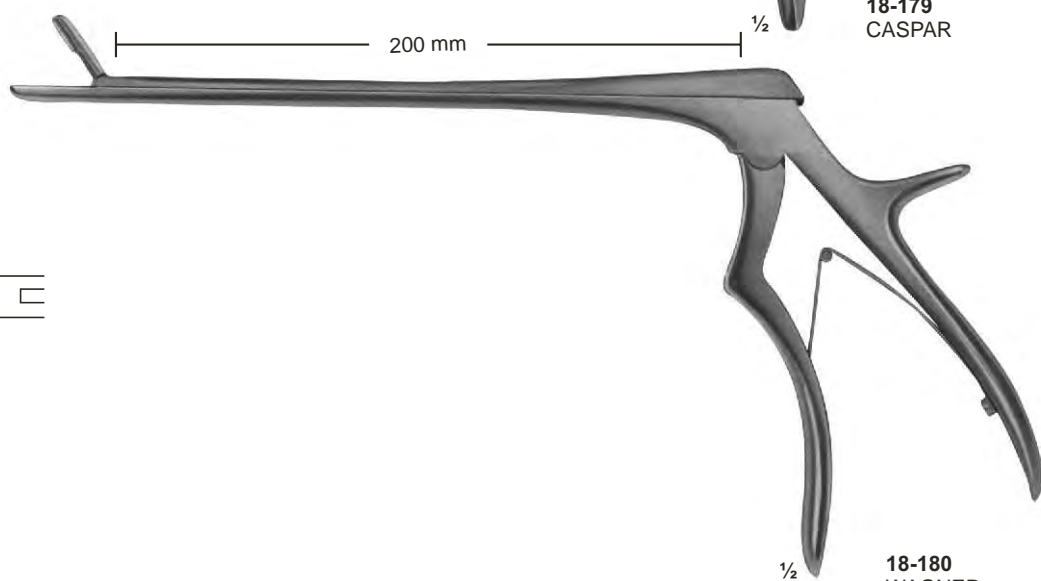

**18-180**  
5,5 mm



200 mm

1/2

**18-180**  
WAGNER



**19-101**  
Comprimeter. Compression apparatus for producing exsanguination in the extremities. Manometer registers up to 600 mm Hg. Complete, consisting of :  
**19-101** 2 Pump with manometer  
**19-102** 3 Cuff for the leg  
**19-103** 14 Cuff for the upper arm



**19-104** 3 Cuff for the leg  
**19-105** 4 Cuff for the lower arm  
**19-106** 5 Cuff for children  
**19-107** 14 Cuff for the upper arm



**19-108**  
ESMARCH  
Staubinde  
Compression bandage  
5 m lang/long  
6 cm breit/wide



**19-109**  
ESMARCH  
Stauschlauch  
Compression tube  
1 m lang/long



**19-110**  
Length of blades  
Phalangeal knife  
105 mm



**19-111**  
Length of blades  
Interosseous knife  
110 mm



**19-112**  
Length of blades  
Periosteum knife  
with raspator  
65 mm



**19-113 - 114**  
LANGENBECK  
Length of blades  
Resection knives  
55 mm



**19-113**



**19-114**

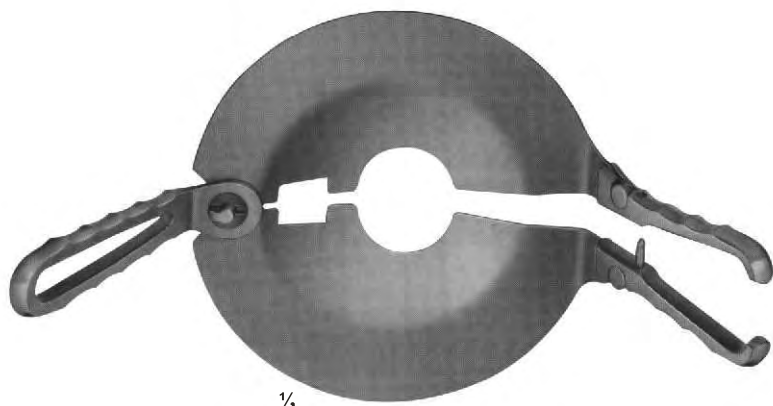

1/2

**19-115**  
PERCY  
removeable handles

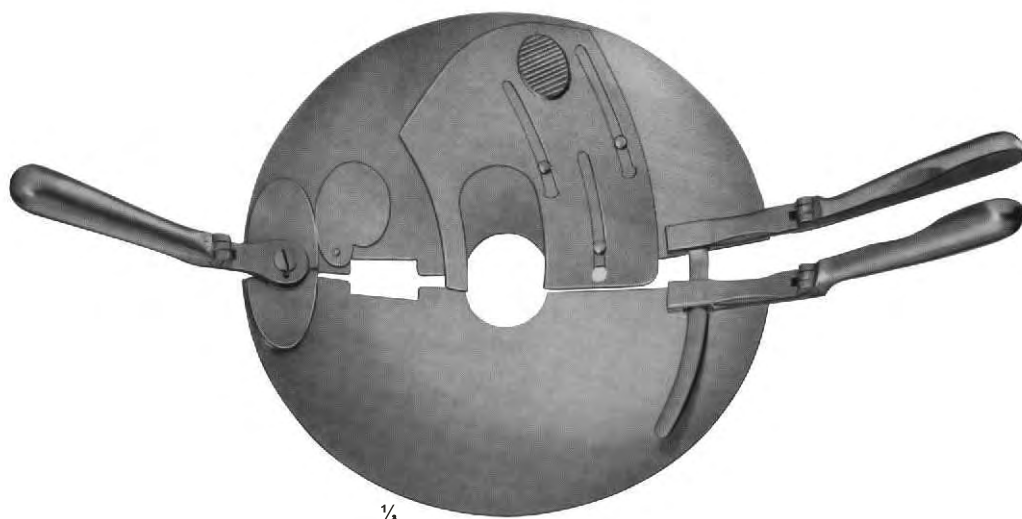

1/2

**19-116**  
PERCY  
reversible handles



1/4  
**19-117**  
 CHARRIEER  
 Length of blade  
 215 mm  
 complete with one saw  
 blade each  
 350 mm  
 Spare saw blades, carbon steel  
**19-118** 12 mm  
**19-119** 20 mm

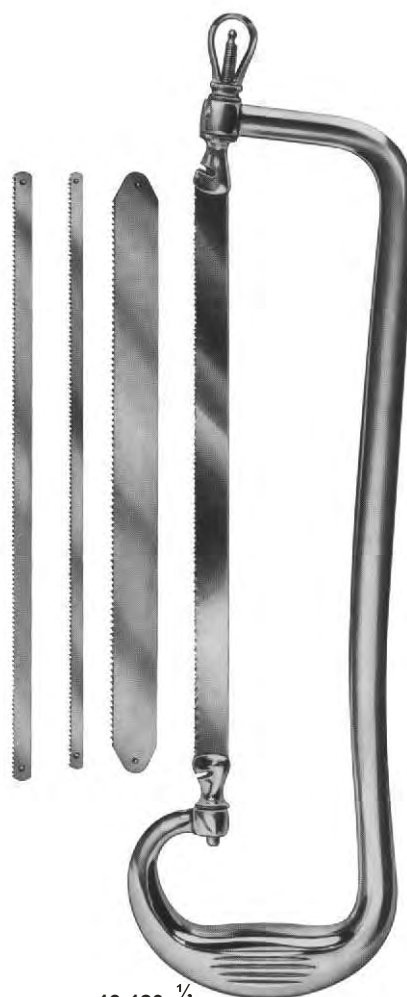

1/4  
**19-120**  
 RUST  
 Length of blade  
 235 mm  
 complete with one saw  
 blade each  
 390 mm  
**19-121** Bow only  
 Spare saw blades, carbon steel  
**19-122** 6 mm  
**19-123** 8 mm  
**19-124** 12 mm  
**19-125** 20 mm

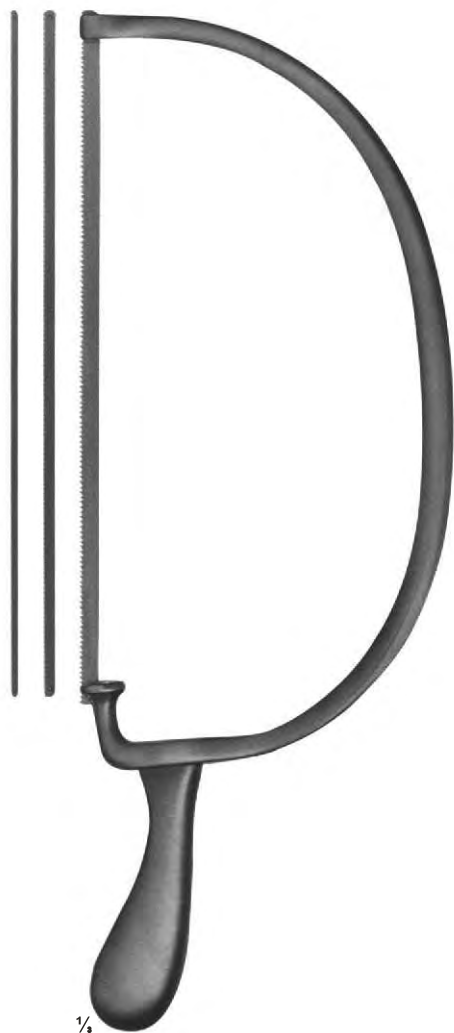

1/4

**19-126**  
**BIER**  
 Length of blade  
 270 mm  
 complete with one saw  
 blade each  
 420 mm  
 Spare saw blades, carbon steel  
**19-127** 4 mm  
**19-128** 6 mm  
**19-129** 8 mm



1/4

**19-130**  
**CHARRIERE**  
 Length of blade  
 180 mm  
 Spare saw blades,  
 carbon steel  
 270 mm

**19-131**  
**CHARRIERE**  
 Length of blade  
 240 mm  
 Spare saw blades,  
 carbon steel  
 340 mm



1/4

**19-132**  
**SATTERLEE**  
 Length of blade  
 200 mm  
 Spare saw blades,  
 carbon steel  
 290 mm



1/4

**19-133**  
**LANGENBACK**  
 Length of blade  
 115 mm  
 Metacarpal saw  
 235 mm



**OLIVECRONA**  
**19-134** 300 mm  
**19-135** 400 mm  
**19-136** 500 mm  
**19-137** 700 mm

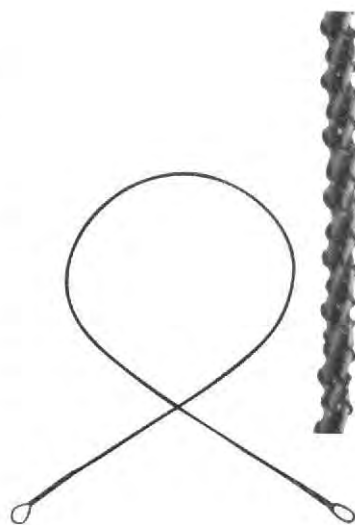

**GIGLI**  
**19-138** 300 mm  
**19-139** 400 mm  
**19-140** 500 mm  
 fine, 6 wires twisted  
**19-141**  
 coares, 4 wires twisted



$\frac{1}{4}$   
**19-142**  
 GIGLI  
 Handle



$\frac{1}{2}$   
**19-143**  
 LEBSCHKE  
 Conductor for  
 wire saws, malleable  
 250 mm

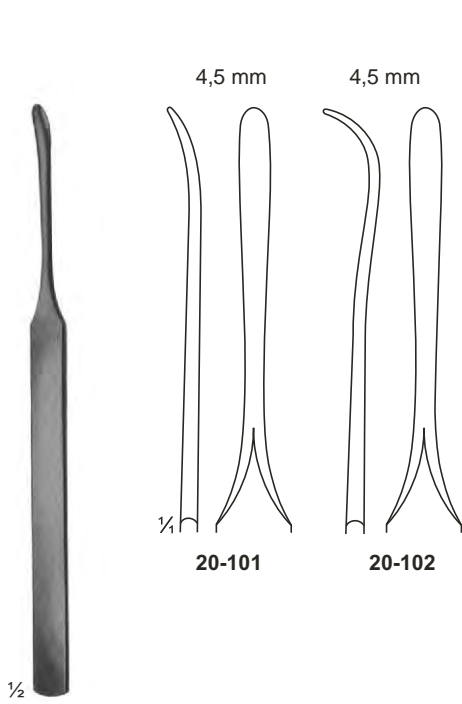

**20-101 - 102**  
KONIG  
155 mm

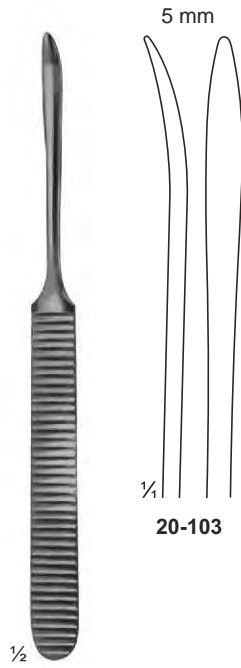

**20-103**  
WILLIGER  
165 mm

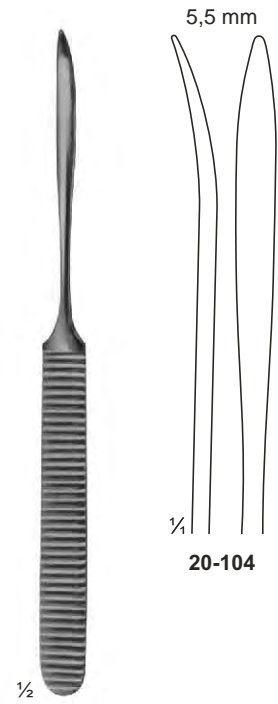

**20-104**  
WILLIGER  
170 mm

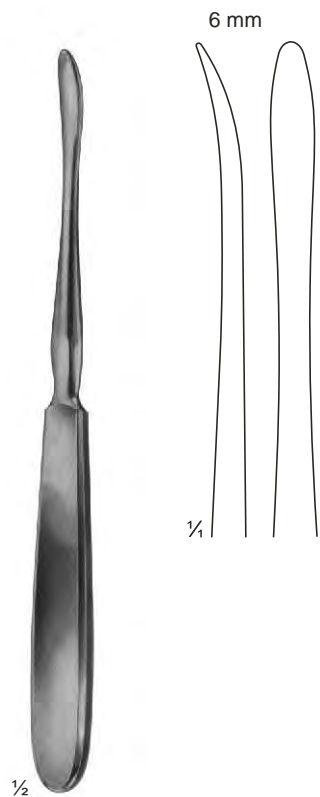

**20-105**  
QUERVAIN  
195 mm

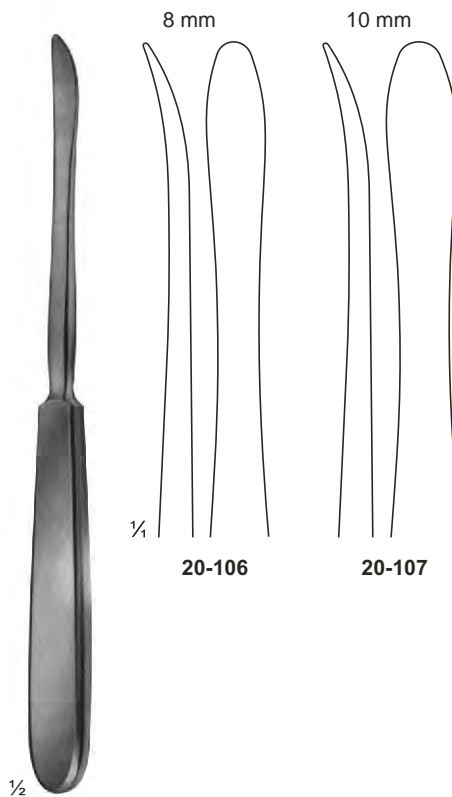

**120-106 - 107**  
LANGENBACK  
195 mm

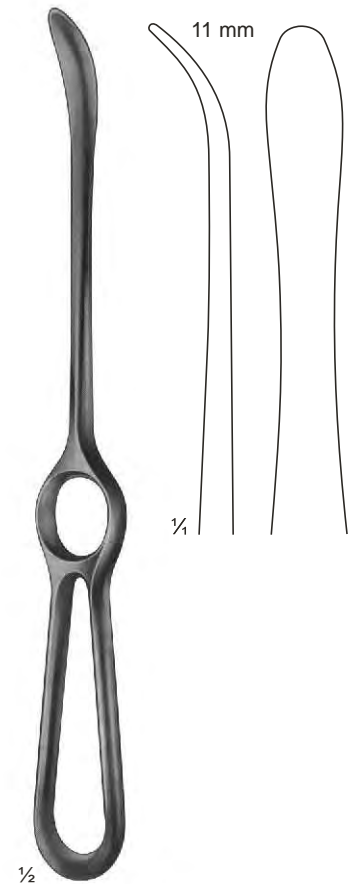

**20-108**  
LANGENBACK  
230mm

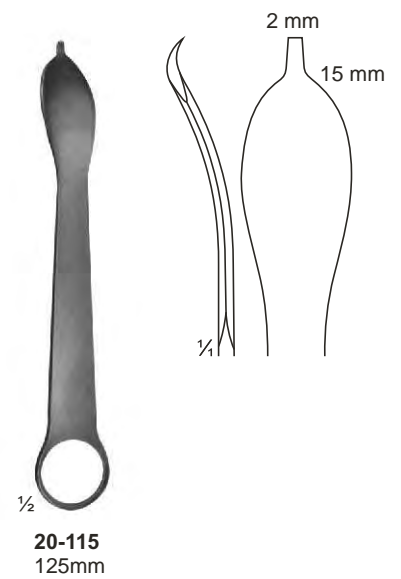
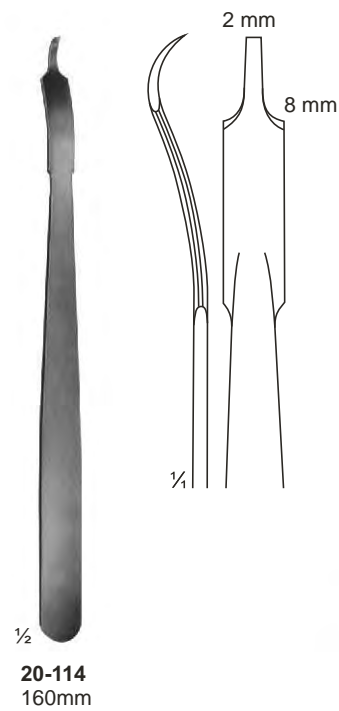
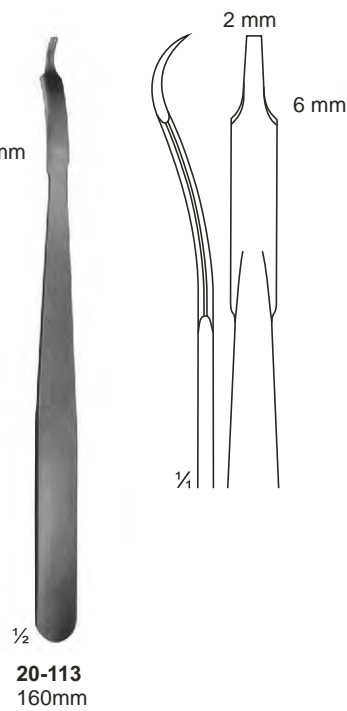
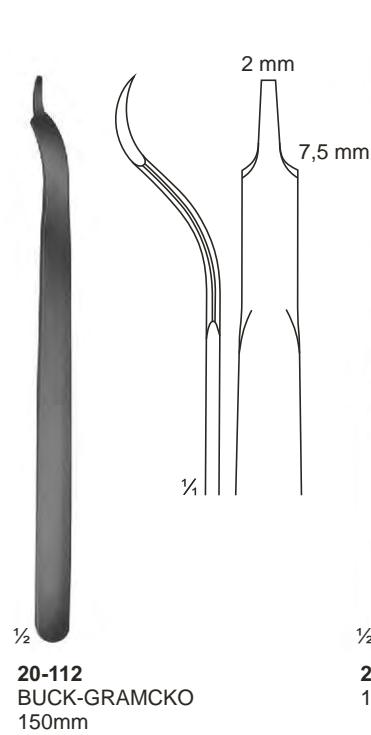
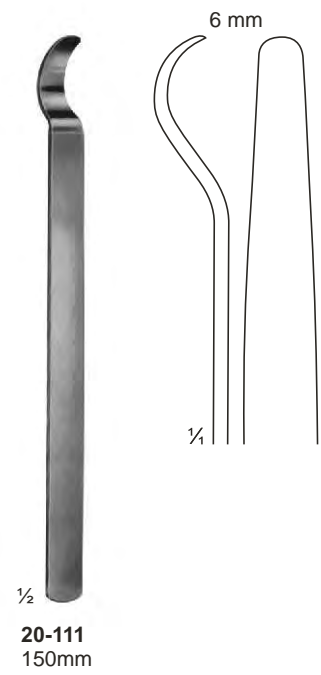
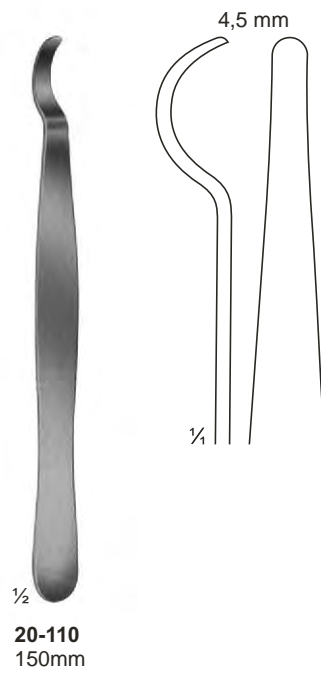
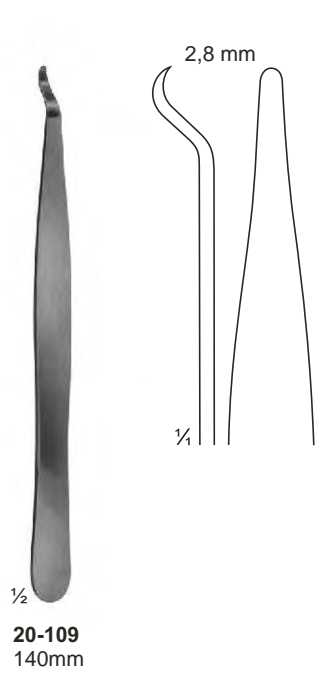



**20-116**  
LANE TRETHOWAN  
215mm

**20-117**  
LANE  
255mm

**20-118**  
LANGE-HOHMANN  
250mm

**20-119 - 120**  
LANGE-HOHMANN  
**20-119** 265mm  
**20-120** 280mm

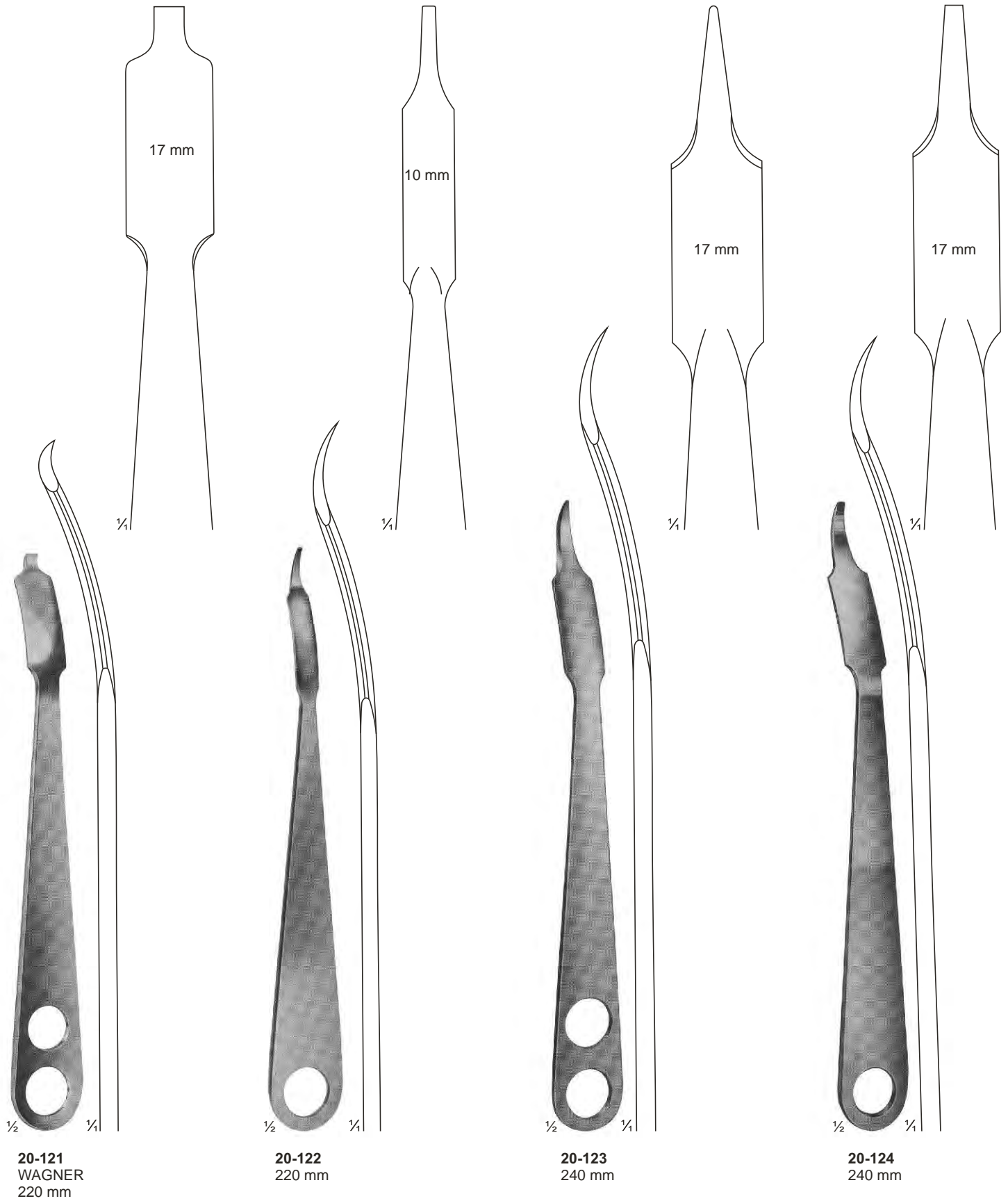

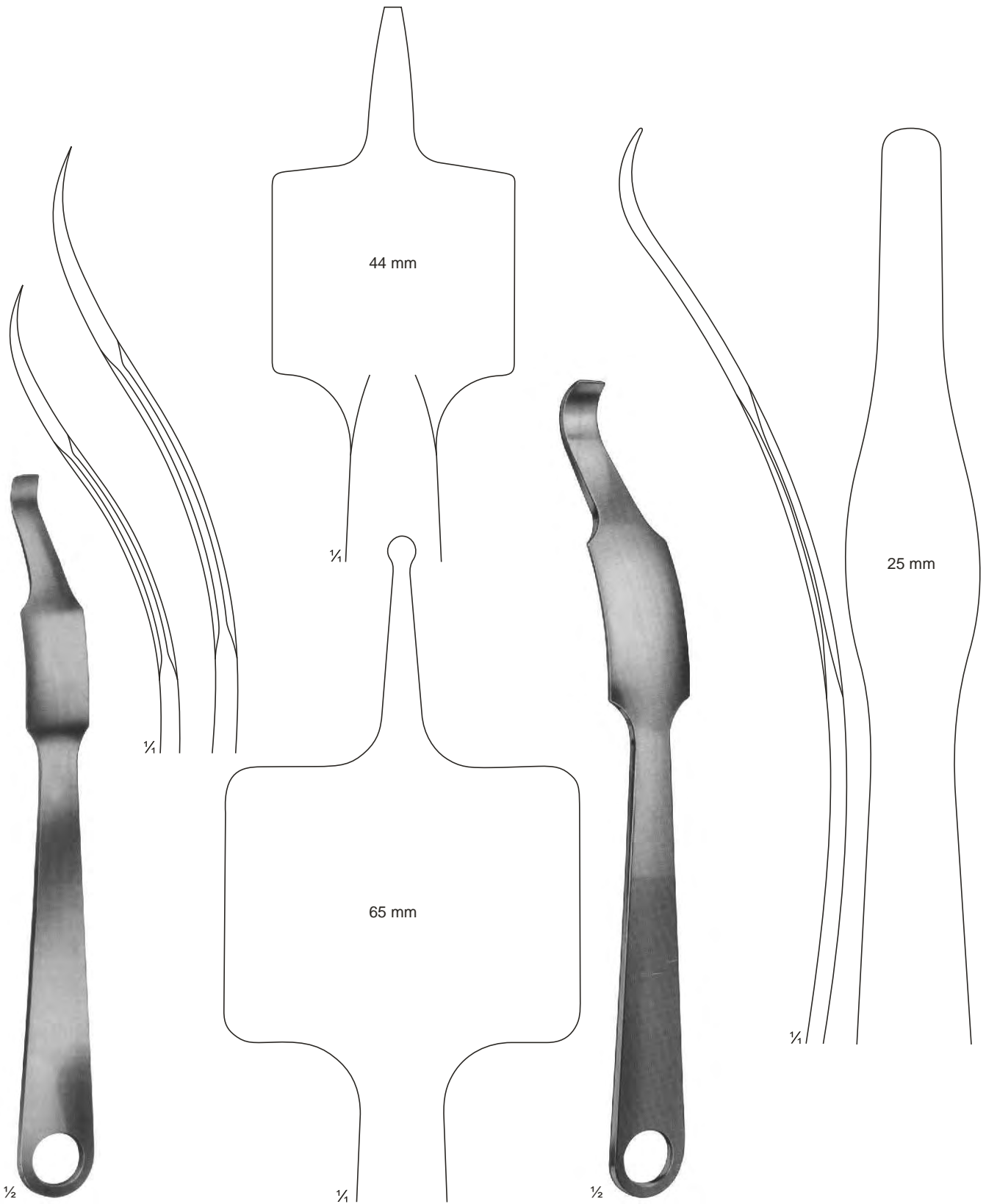

**20-125 - 126**  
**VERBRUGGE-MULLER**  
**20-125** 240 mm  
**20-126** 255 mm

**20-127**  
 260 mm

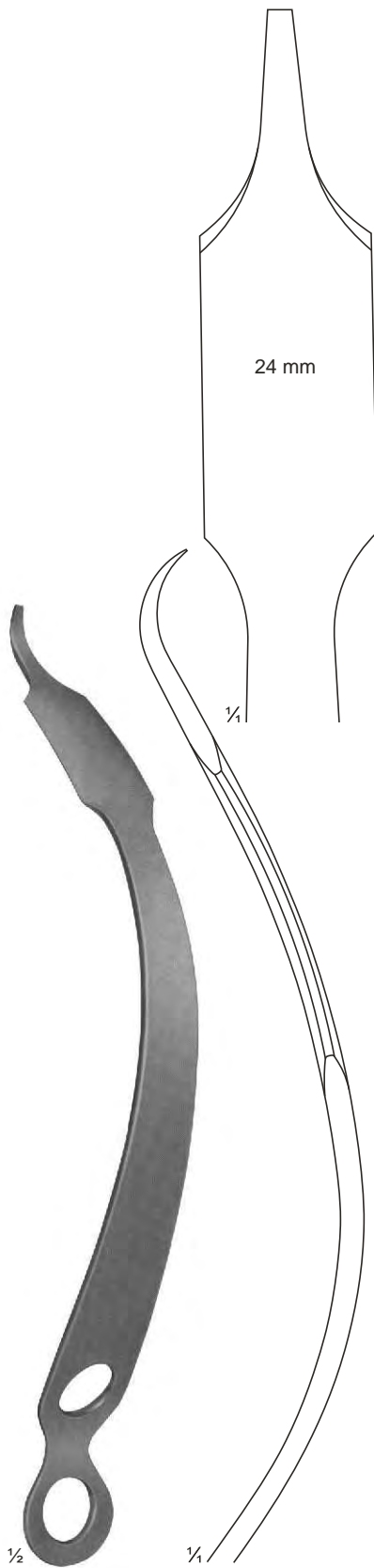

**20-128**  
HOHMANN-ALDINGER  
270 mm

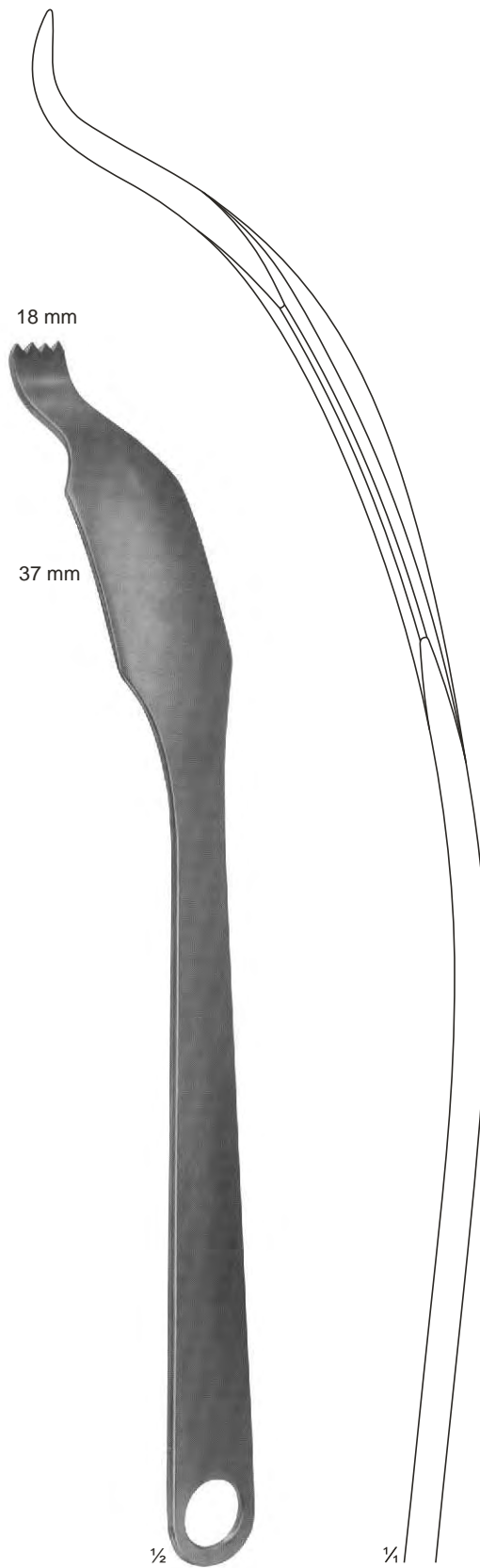

**20-129**  
SCHUMACHER mod. WAGNER  
345 mm

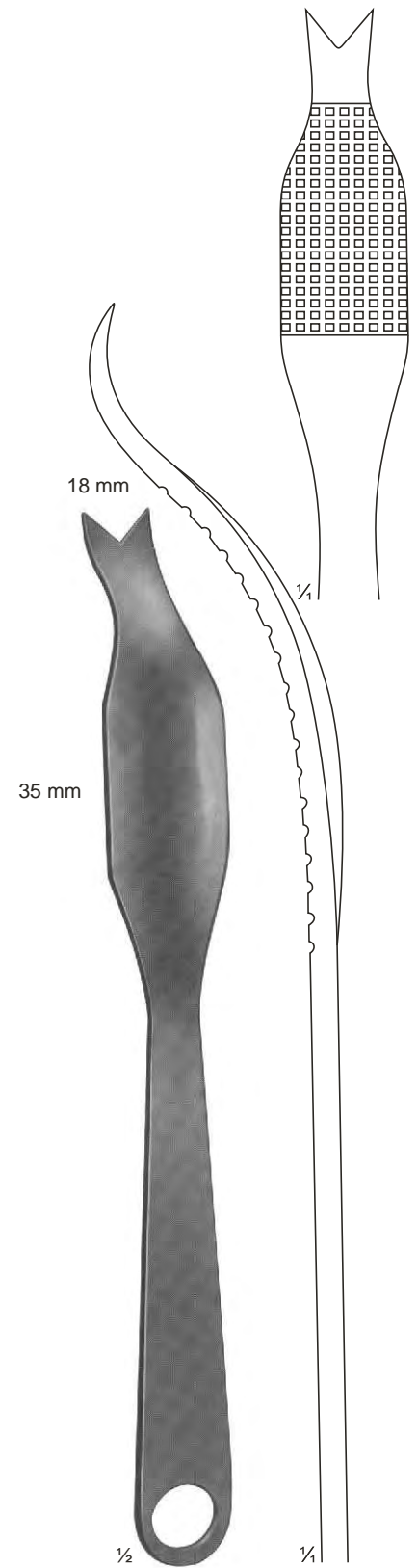

**20-130**  
SCHUMACHER  
290 mm

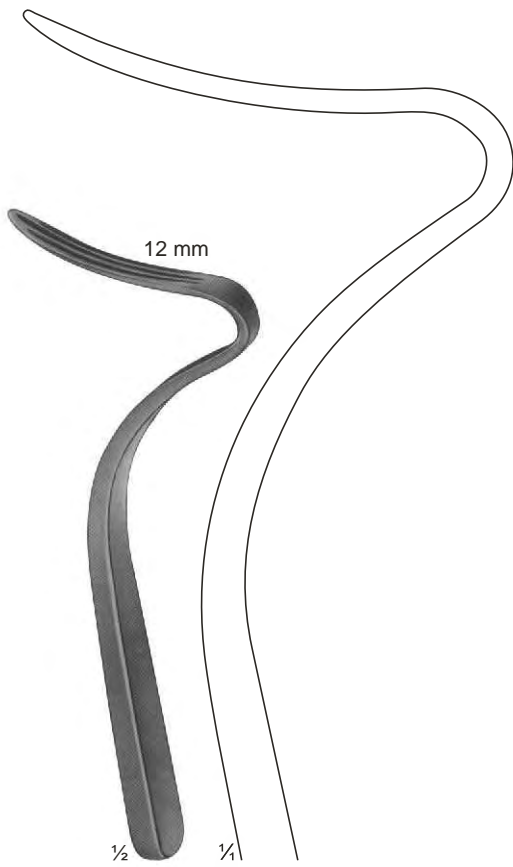

**20-131**  
**TAGER**  
 Bone lever for  
 angle joint operations  
 175 mm

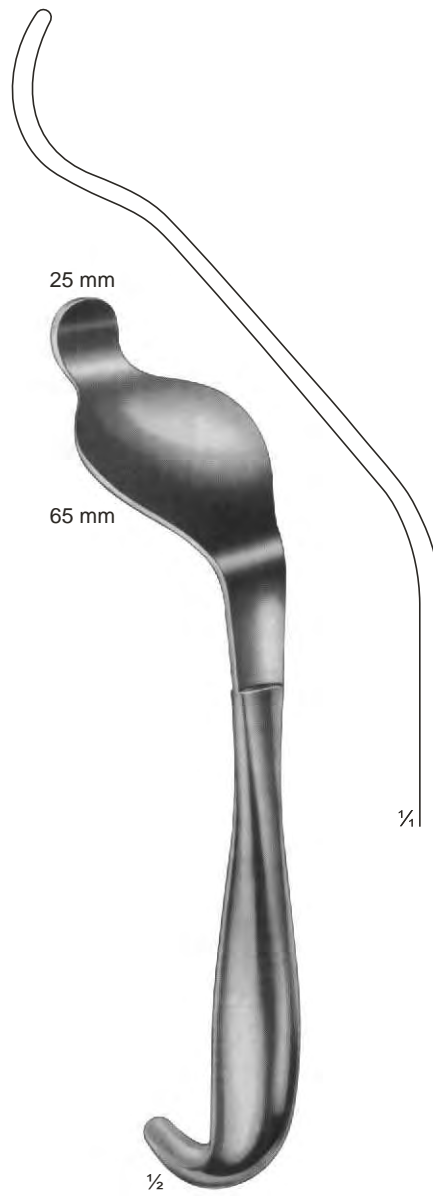

**20-132**  
**BENNETT**  
 235 mm

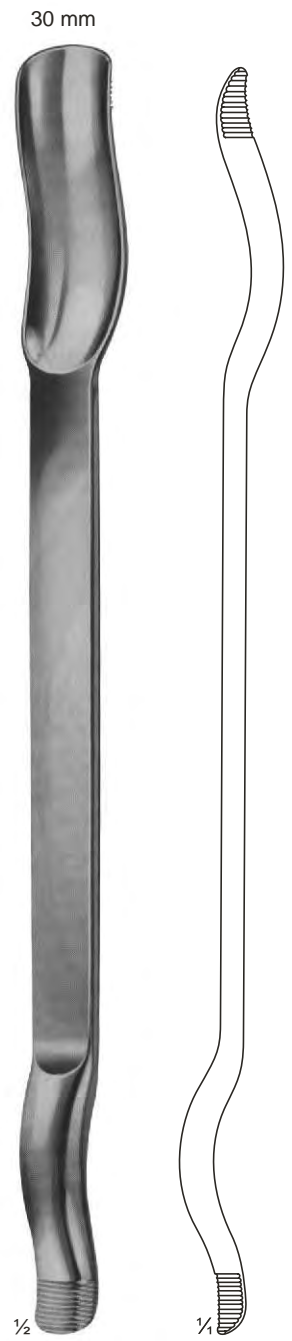

**20-133**  
**MURPHY-LANE**  
 Luxation lever  
 340 mm

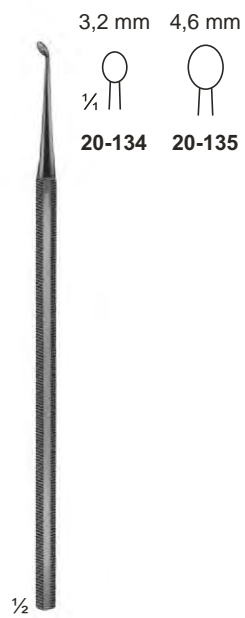

**20-134 - 135**  
PARTSCH  
150 mm

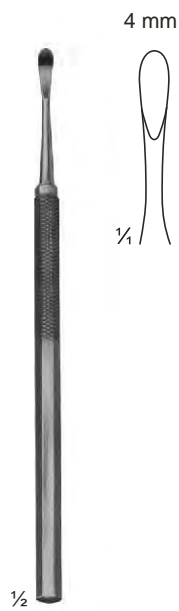

**20-136**  
PARTSCH mod. LANGE  
145 mm



**20-137**  
MC KENTY  
155 mm

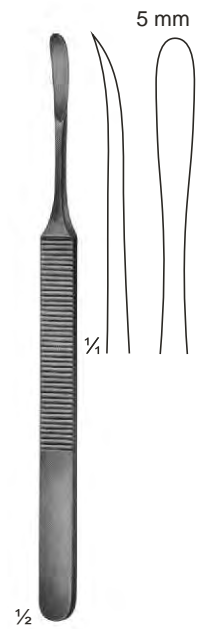

**20-138**  
KONIG  
155 mm

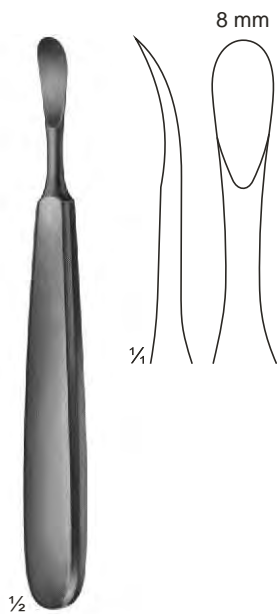

**20-139**  
TRELAT  
150 mm

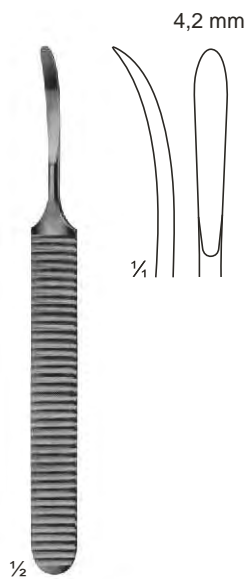

**20-140**  
WILLIGER  
140 mm

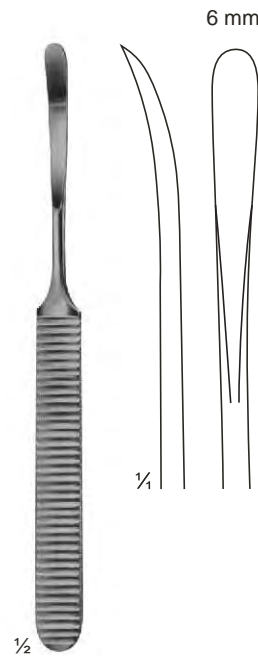

**20-141**  
WILLIGER  
160 mm

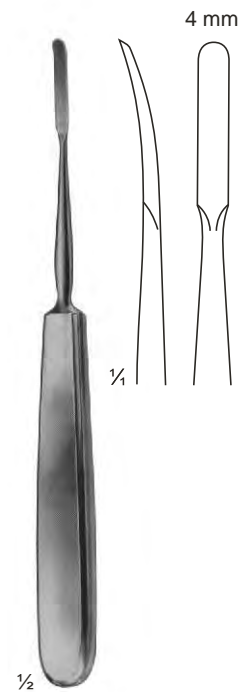

**20-142**  
JOSEPH  
170 mm

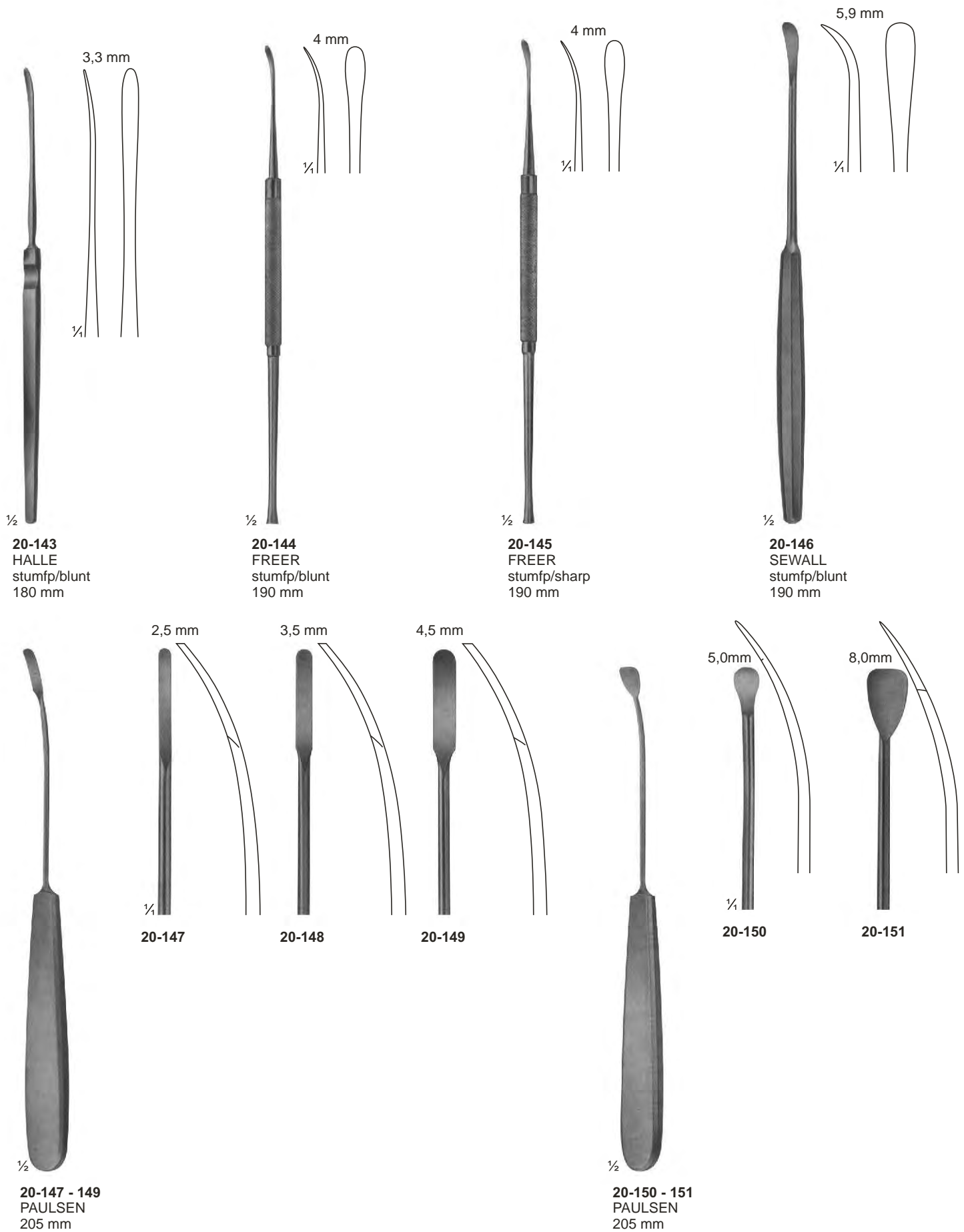

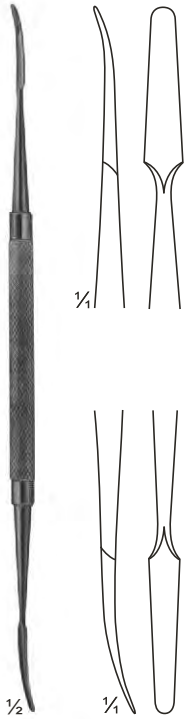

**20-152**  
KILLIAN  
sharp/blunt  
185 mm

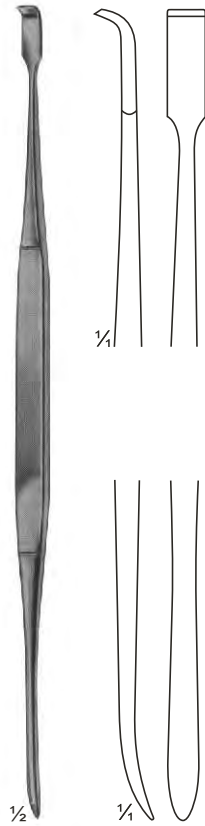

**20-153**  
HOWARTH  
sharp/blunt  
215 mm

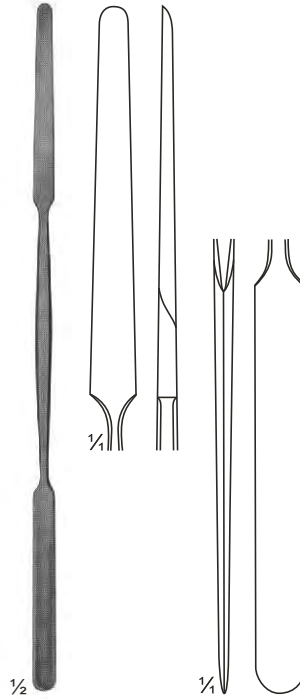

**20-154**  
KILLIAN  
sharp/blunt  
185 mm

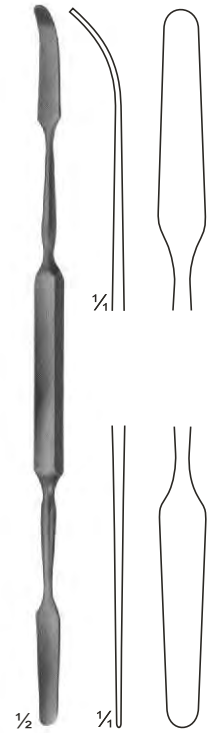

**20-155**  
MAC DONALD  
blunt/blunt  
185 mm

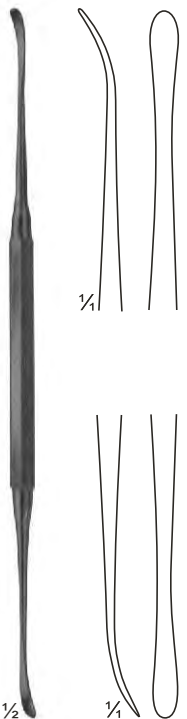

**20-156**  
FREER  
sharp/blunt  
185 mm

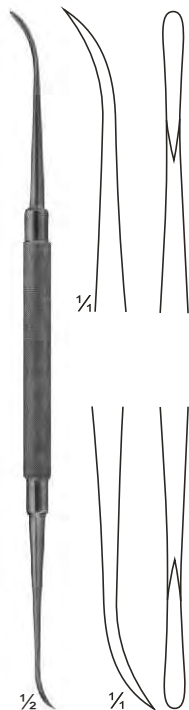

**20-157**  
FREER-YASARGIL  
sharp/sharp  
185 mm

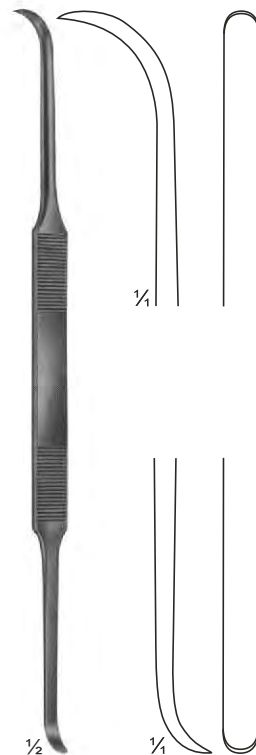

**20-158**  
COTTLE  
sharp/sharp  
200 mm

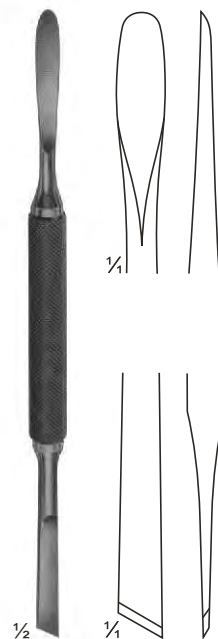

**20-159**  
MEAD  
sharp/sharp  
165 mm

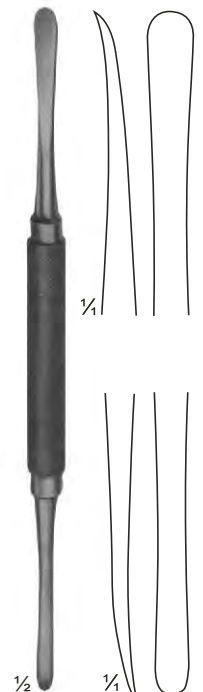

**20-160**  
MOLT  
sharp/sharp  
180 mm

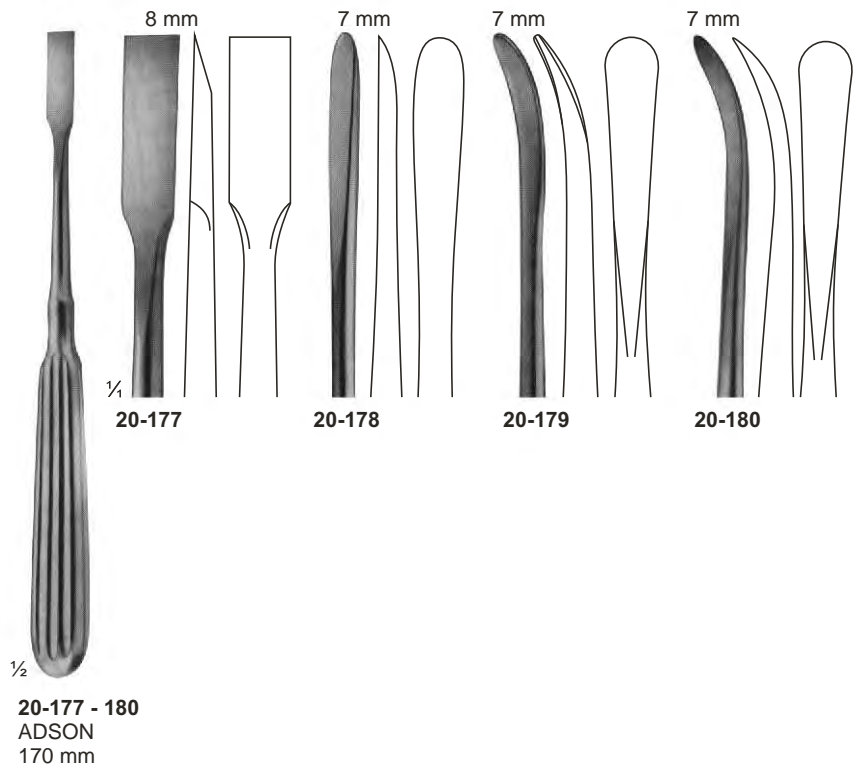
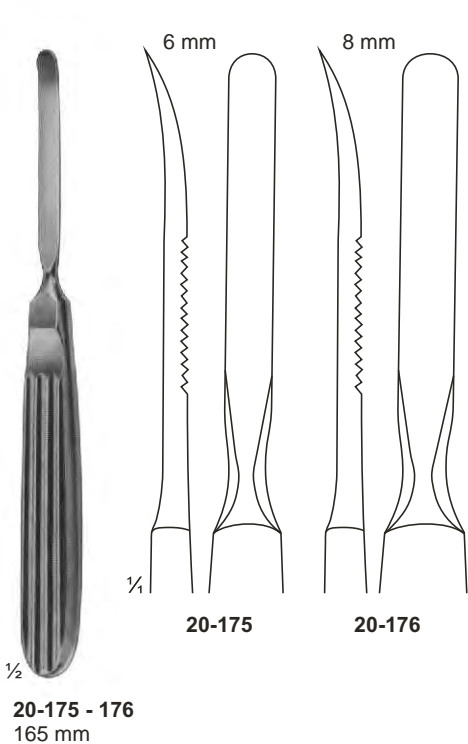
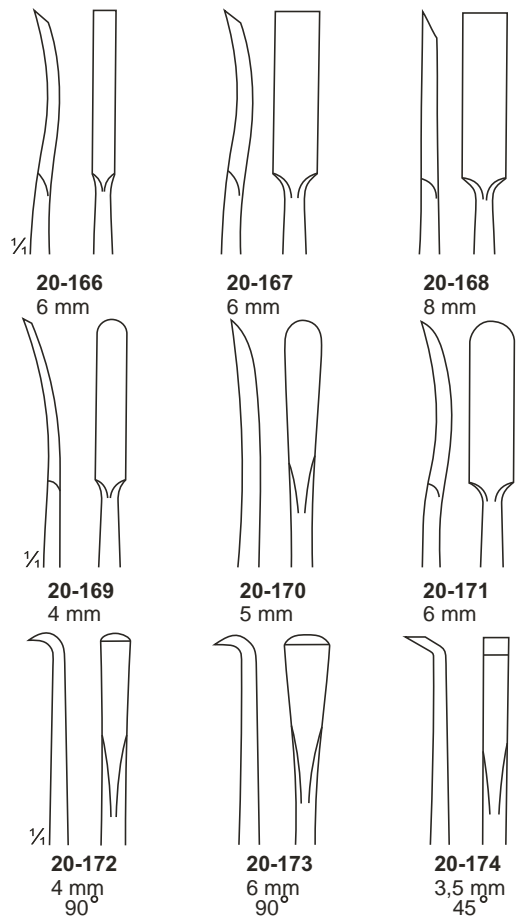
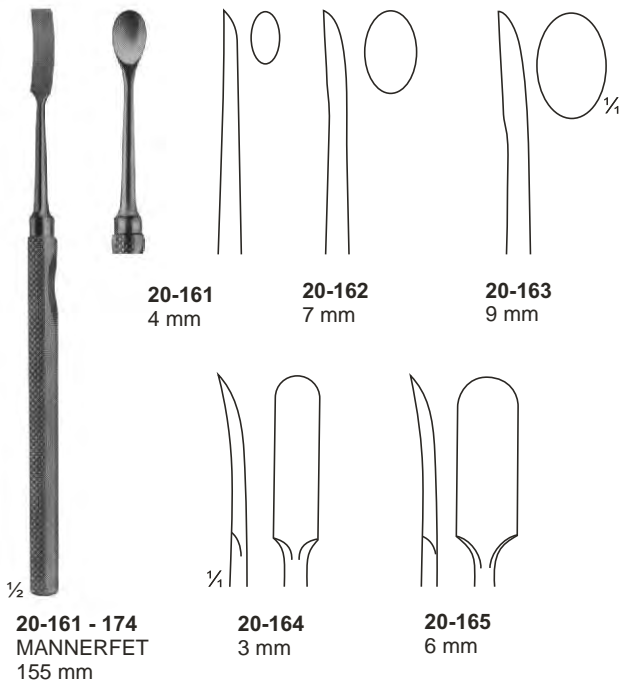

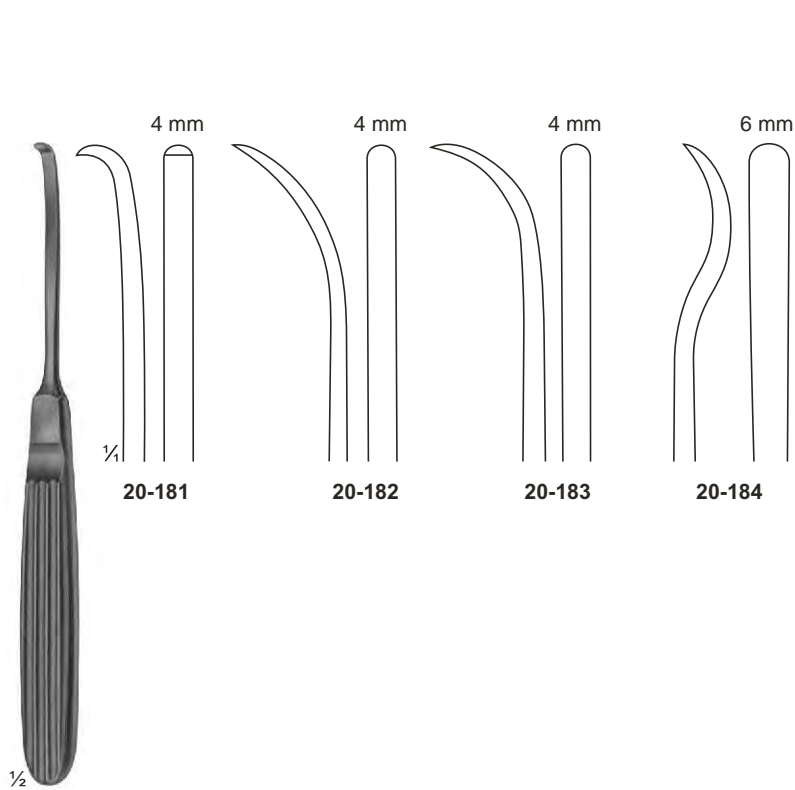

**20-181 - 184**  
**MUHLING**  
 170 mm

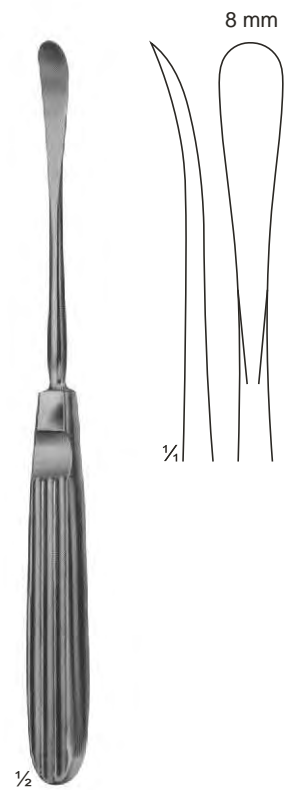

**20-185**  
**COTTLE**  
 175 mm

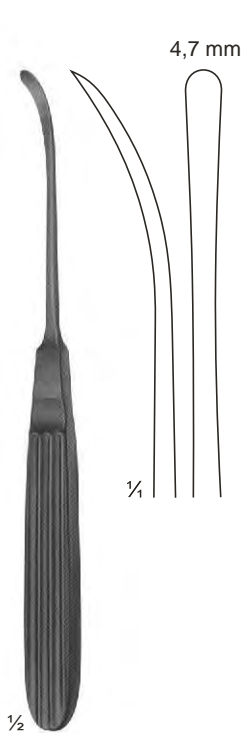

**20-186**  
**LANDOT**  
 175 mm

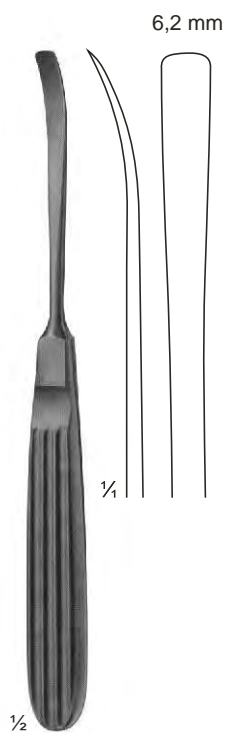

**20-187**  
**CASPER**  
 180 mm

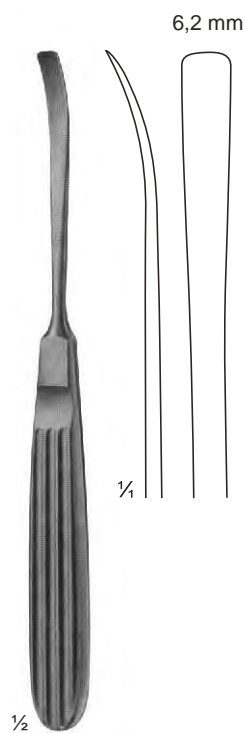

**20-188**  
**CASPER**  
 180 mm

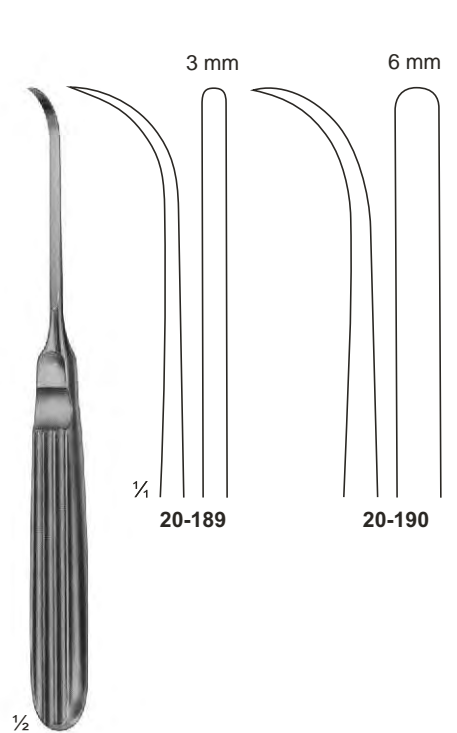

**20-189 - 190**  
 170 mm

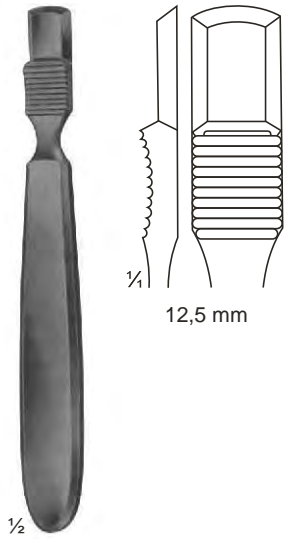

**20-191**  
FARABEUF  
140 mm

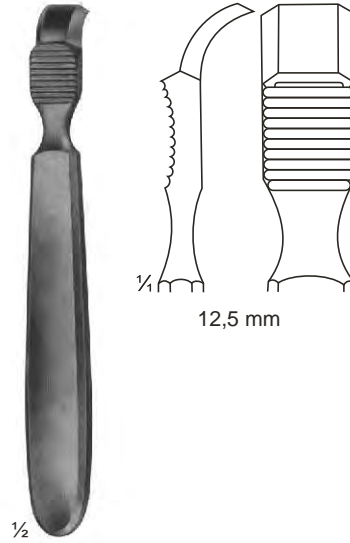
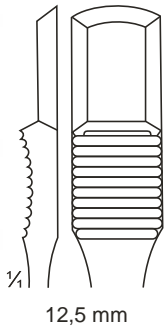

**20-192**  
FARABEUF  
140 mm

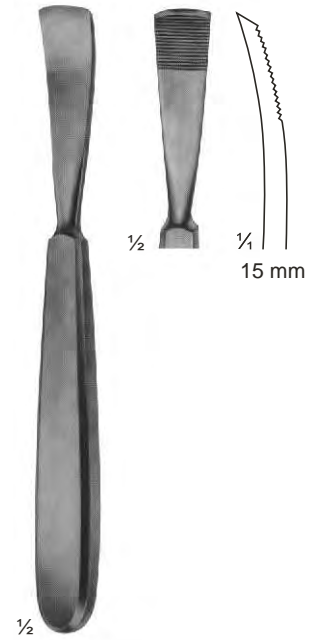
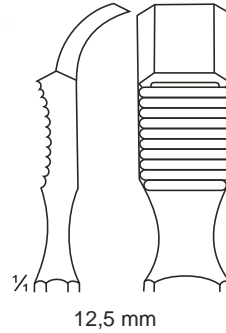

**20-193**  
JANSEN  
165 mm

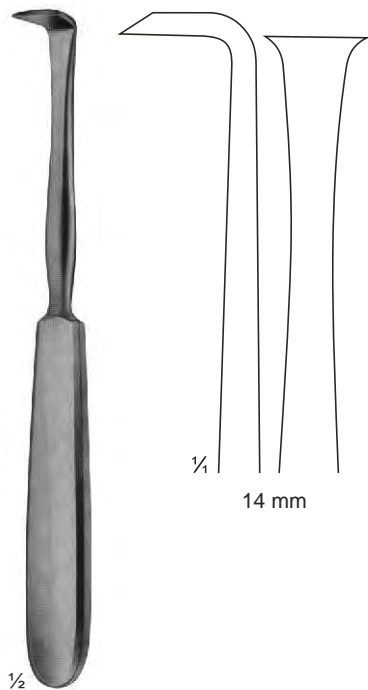
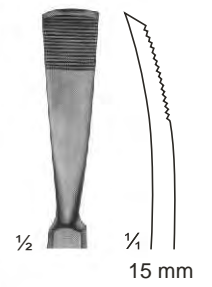

**20-194**  
LANGENBACK  
180 mm

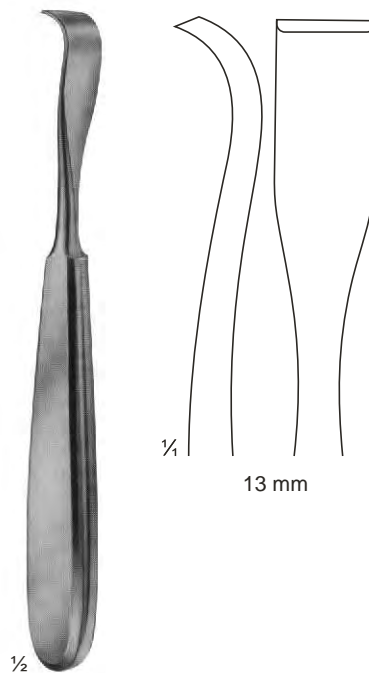
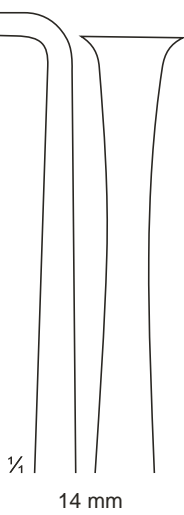

**20-195**  
SCHNEIDER  
175 mm

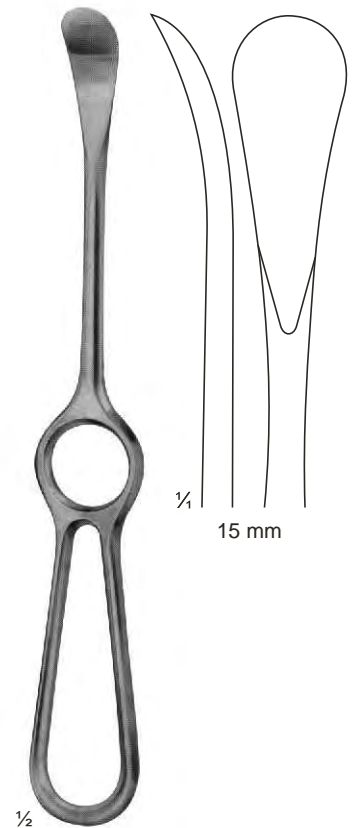

**20-196**  
SEDILLOT  
215 mm

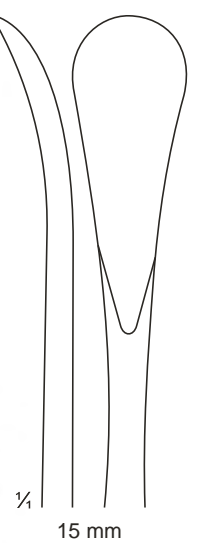

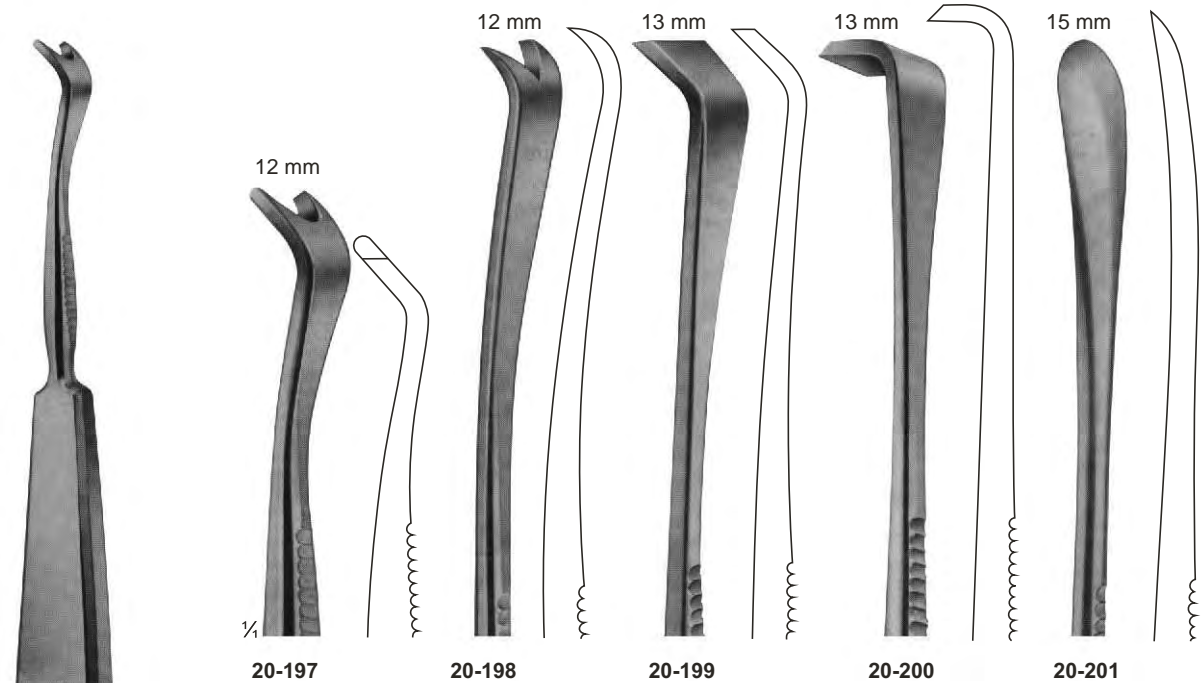

1/2  
**20-197 - 201**  
 SEMB  
 230 mm



1/4  
**20-206**                      **20-207**

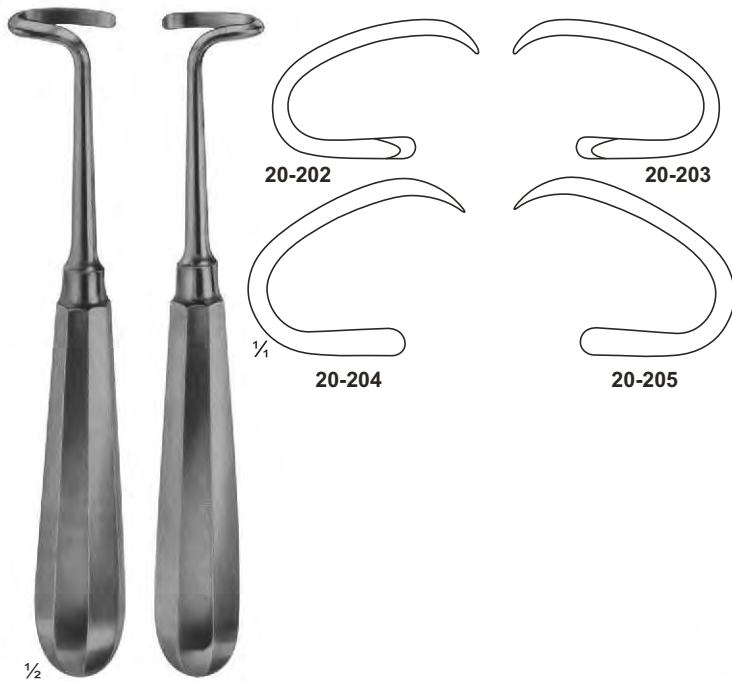

1/2  
**20-202 - 203**  
 DOYEN  
 for children  
**20-204 - 205**  
 for adults  
 175 mm

1/2  
**20-206 - 207**  
 DOYEN  
 240 mm

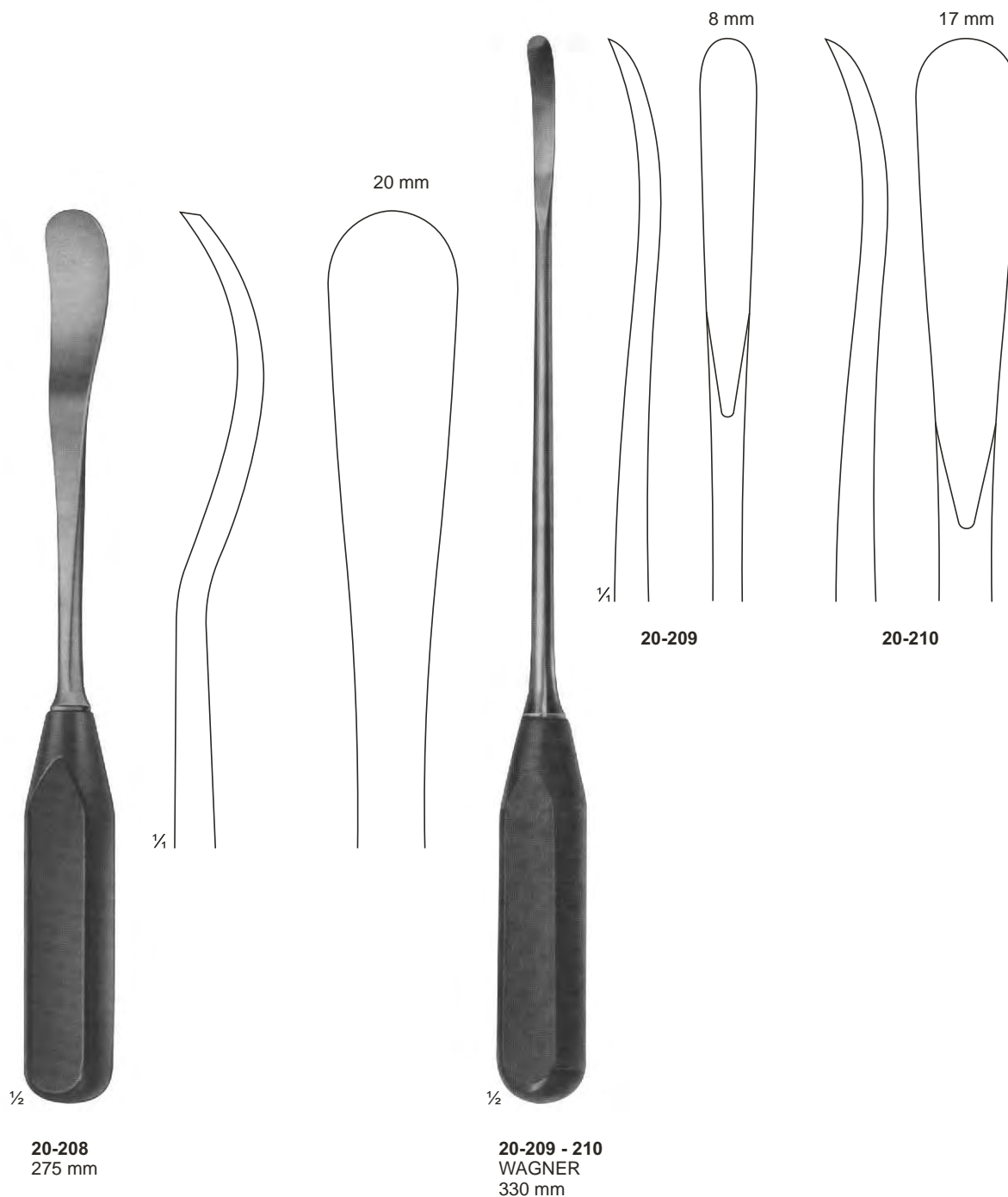

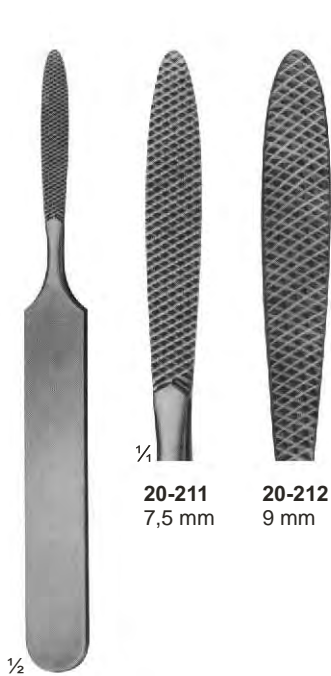

20-211  
7,5 mm

20-212  
9 mm

1/2

**20-211**  
JOSEPH  
fine, chequered

**20-212**  
coarse, chequered  
165 mm

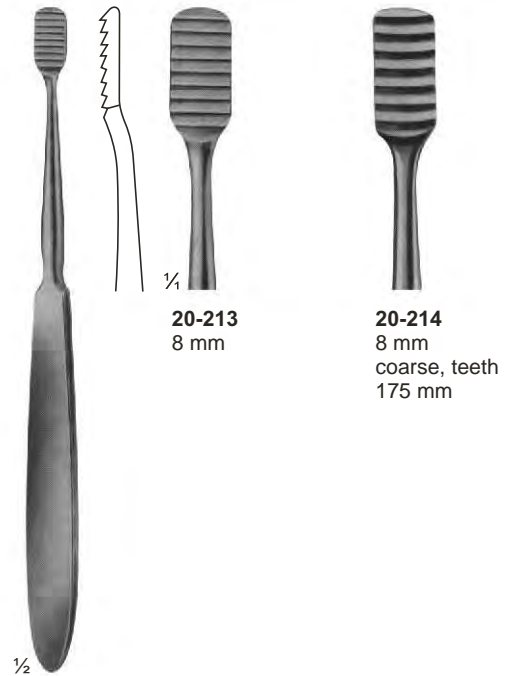

20-213  
8 mm

20-214  
8 mm  
coarse, teeth  
175 mm

1/2

**20-213**  
LEWIS  
fine, teeth



20-215  
9 mm

1/2

**20-215**  
MALTZ  
down stroke  
180 mm

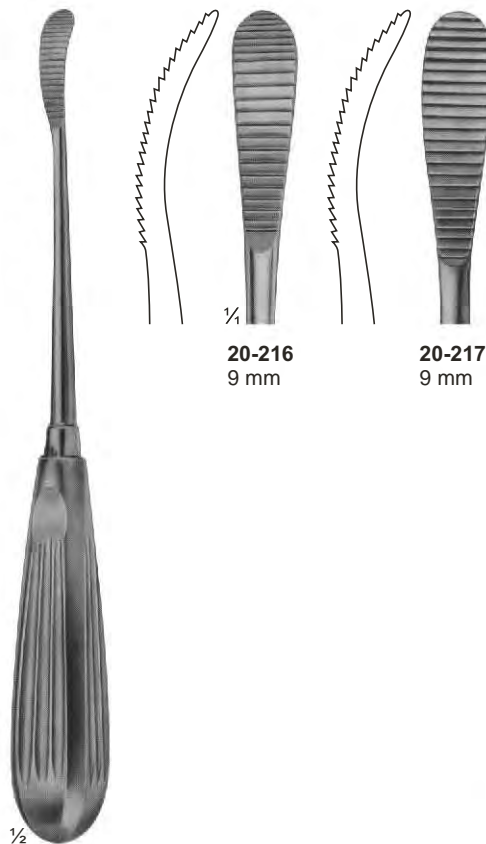

20-216  
9 mm

20-217  
9 mm

1/2

**20-216**  
AUFRICHT  
up stroke  
**20-217**  
down stroke  
220 mm



20-218  
6,5 mm

1/2

**20-218**  
GALLAHER  
190 mm

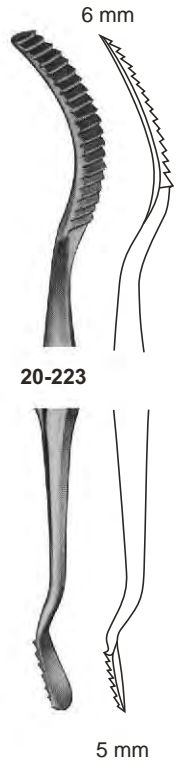
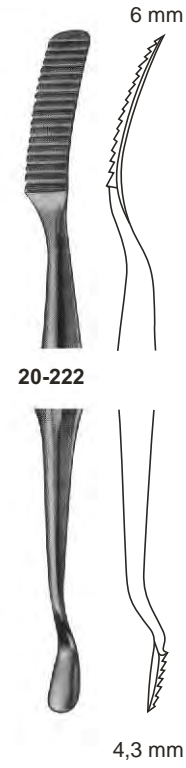
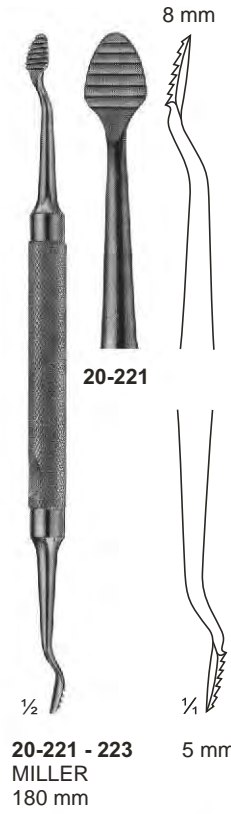
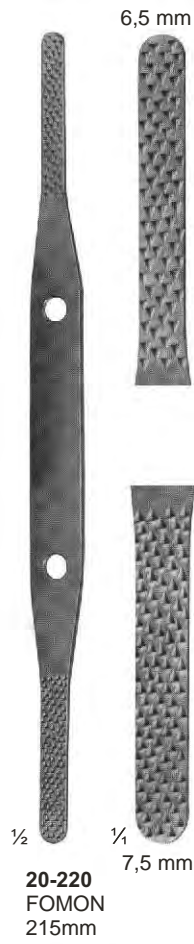
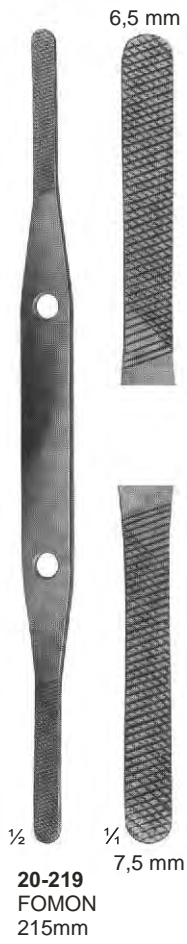

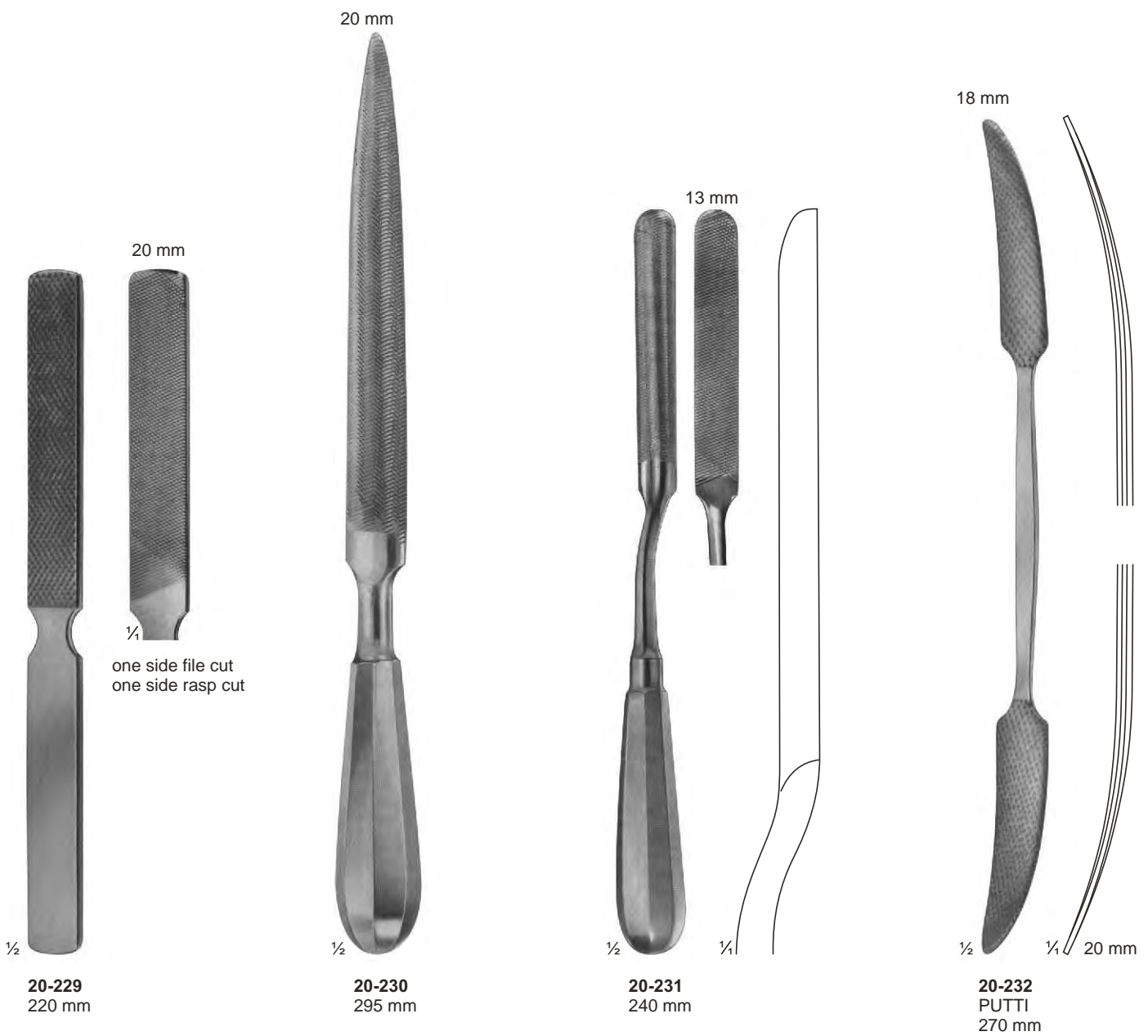



**20-233**  
JACOBSON  
140 mm

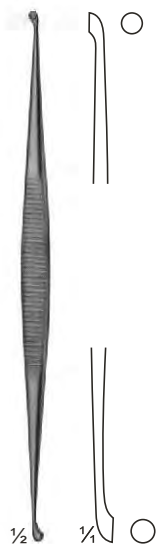

**20-234**  
MARTINI  
140 mm



**20-235**  
MARTINI  
140 mm



**20-236**  
WILLIGER  
145 mm



**20-237**  
JANSEN  
160 mm



**20-238**  
BARTH  
180 mm

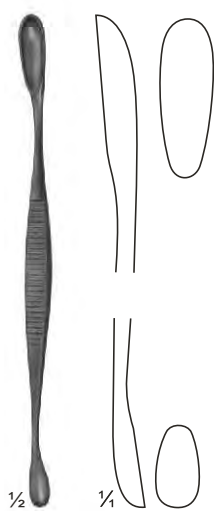

**20-239**  
VOLKMANN  
130 mm

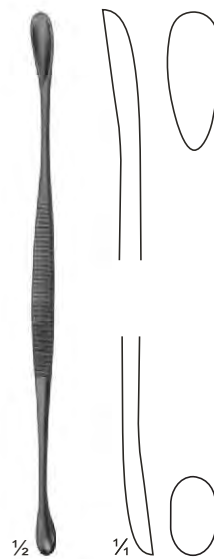

**20-240**  
VOLKMANN  
145 mm

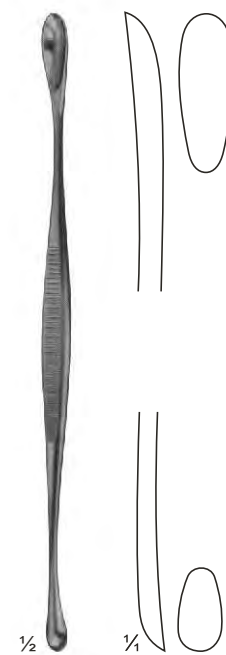

**20-241**  
VOLKMANN  
170 mm



**20-242**  
JANSEN  
160 mm



**20-243**  
HEMINGWAY  
170 mm

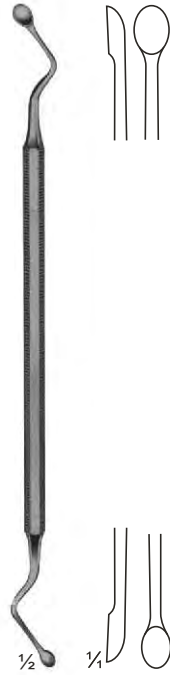

**20-244**  
HEMINGWAY  
175 mm

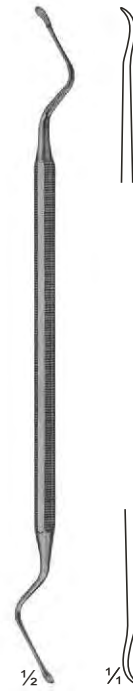

**20-245**  
LUCAS  
180 mm

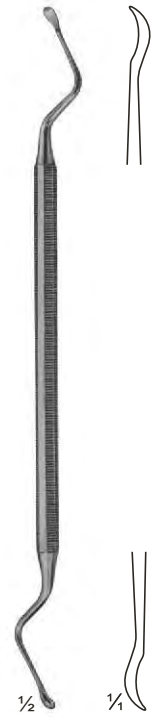

**20-246**  
LUCAS  
185 mm

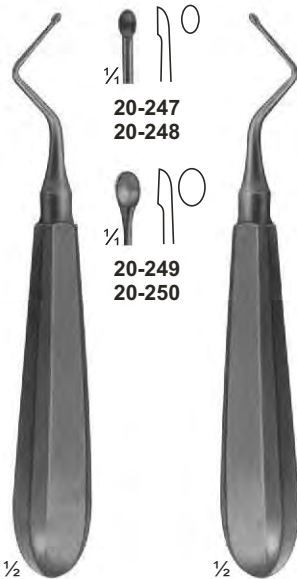

**20-247 - 248**  
KERPEL  
145 mm

**20-249 - 250**  
KERPEL  
145 mm

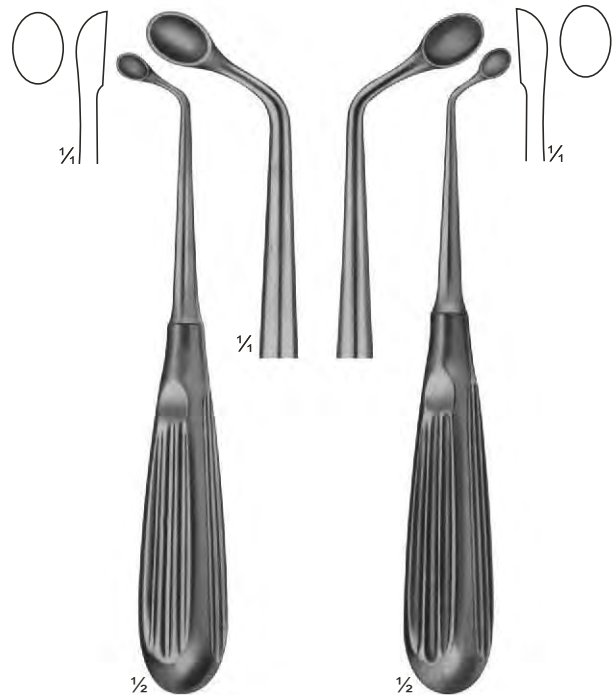

**20-251**  
UFFENDORDE  
170 mm

**20-252**  
UFFENDORDE  
170 mm



½

**20-253 - 259**  
BRUNS  
165 mm



**20-253**  
3 mm  
Fig: 000



**20-254**  
4 mm  
00



**20-255**  
5 mm  
0



**20-256**  
6 mm  
Fig: 1



**20-257**  
8 mm  
2



**20-258**  
10 mm  
3



**20-259**  
12 mm  
4



½

**20-260 - 266**  
SCHEDE  
170 mm



**20-260**  
2,5 mm  
Fig: 000



**20-261**  
3,4 mm  
00



**20-262**  
4,2 mm  
0



**20-263**  
5,2 mm  
Fig: 1



**20-264**  
6,3 mm  
2



**20-265**  
7,4 mm  
3



**20-266**  
8 mm  
4



½

**20-267 - 276**  
VOLKMANN  
170 mm



**20-267**  
2,8 mm  
Fig: 0000



**20-268**  
3,6 mm  
000



**20-269**  
4,4 mm  
00



**20-270**  
5,2 mm  
0



**20-271**  
6,8 mm  
1



**20-272**  
8,5 mm  
Fig: 2



**20-273**  
10 mm  
3



**20-274**  
11,5 mm  
4



**20-275**  
13 mm  
5

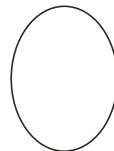

**20-276**  
14,5 mm  
6



½

**20-277 - 278**  
WILLIGER  
170 mm



**20-277**  
3,4 mm  
Fig: 00



**20-278**  
5,2 mm  
1

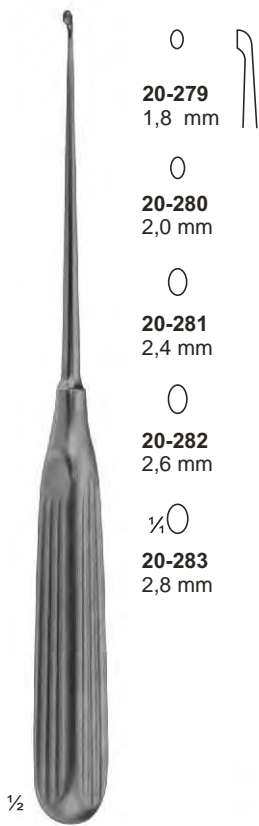

**20-279**  
1,8 mm

**20-280**  
2,0 mm

**20-281**  
2,4 mm

**20-282**  
2,6 mm

**20-283**  
2,8 mm

½

**20-279 - 283**  
LEMPERT  
215 mm

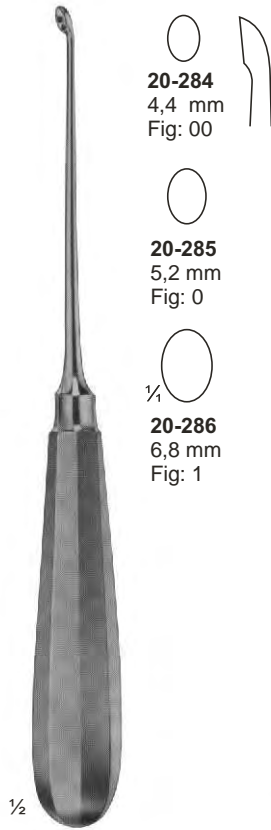

**20-284**  
4,4 mm  
Fig: 00

**20-285**  
5,2 mm  
Fig: 0

**20-286**  
6,8 mm  
Fig: 1

½

**20-284 - 286**  
HALLE  
215 mm

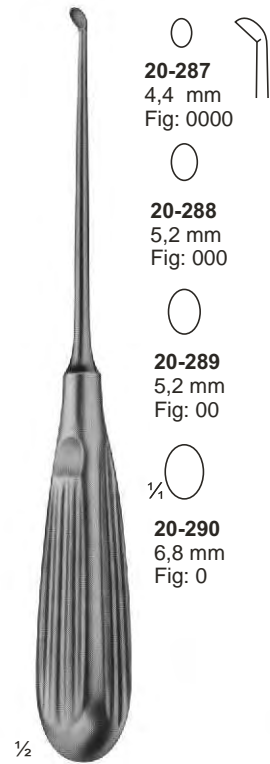

**20-287**  
4,4 mm  
Fig: 0000

**20-288**  
5,2 mm  
Fig: 000

**20-289**  
5,2 mm  
Fig: 00

**20-290**  
6,8 mm  
Fig: 0

½

**20-287 - 290**  
DAUBENSPECK  
200 mm

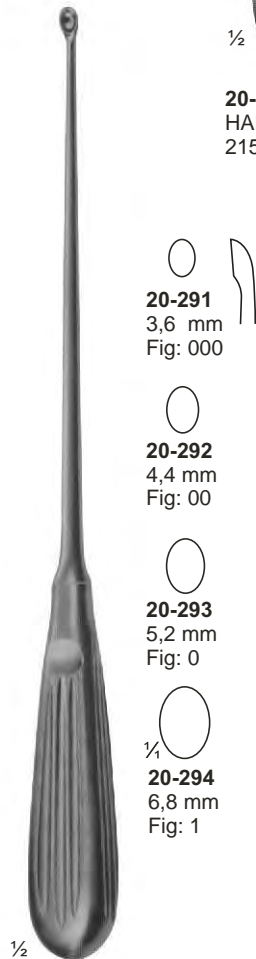

**20-291**  
3,6 mm  
Fig: 000

**20-292**  
4,4 mm  
Fig: 00

**20-293**  
5,2 mm  
Fig: 0

**20-294**  
6,8 mm  
Fig: 1

½

**20-291 - 294**  
250 mm

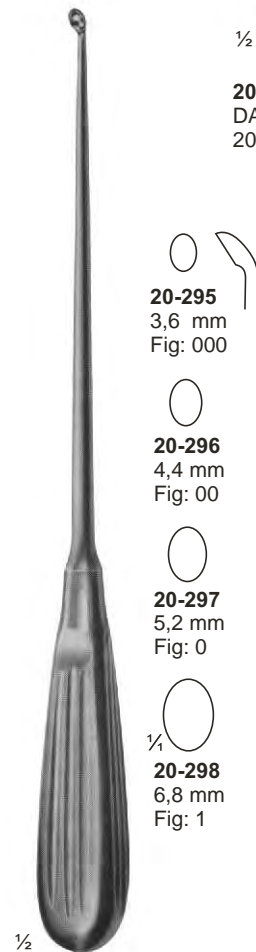

**20-295**  
3,6 mm  
Fig: 000

**20-296**  
4,4 mm  
Fig: 00

**20-297**  
5,2 mm  
Fig: 0

**20-298**  
6,8 mm  
Fig: 1

½

**20-295 - 298**  
250 mm

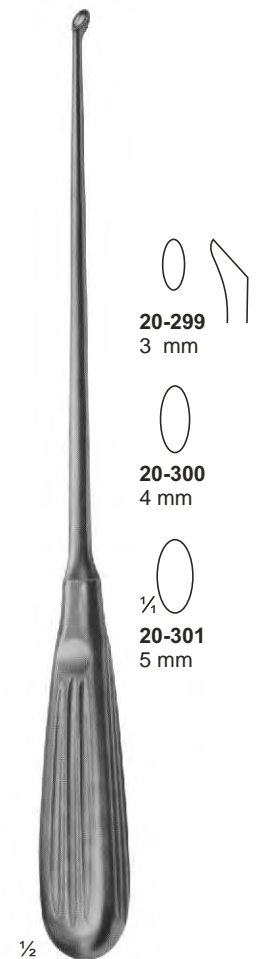

**20-299**  
3 mm

**20-300**  
4 mm

**20-301**  
5 mm

½

**20-299 - 301**  
BUSHE  
250 mm

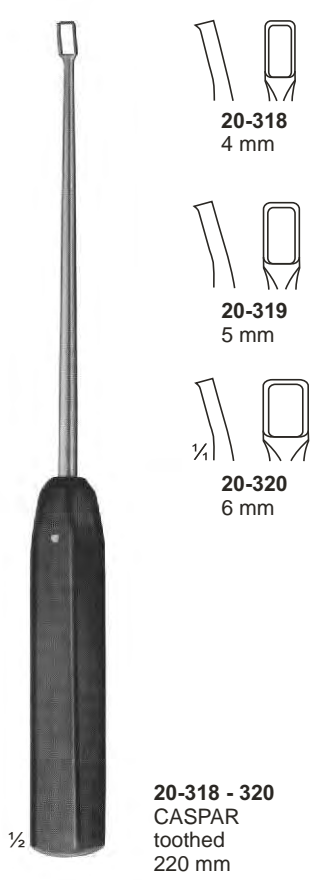
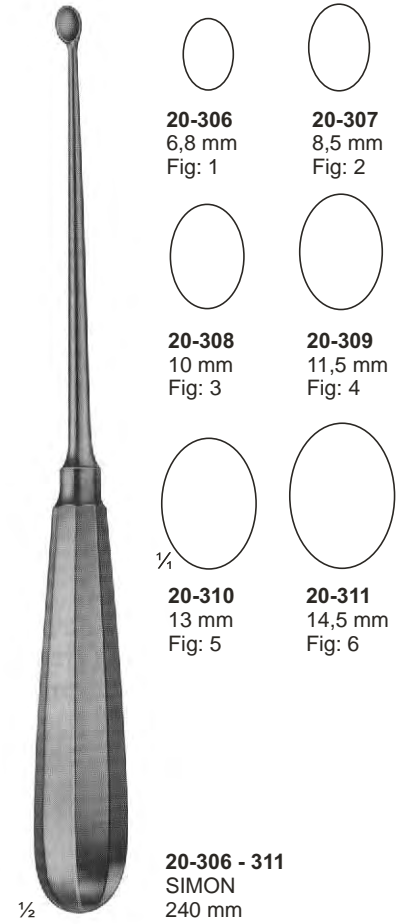

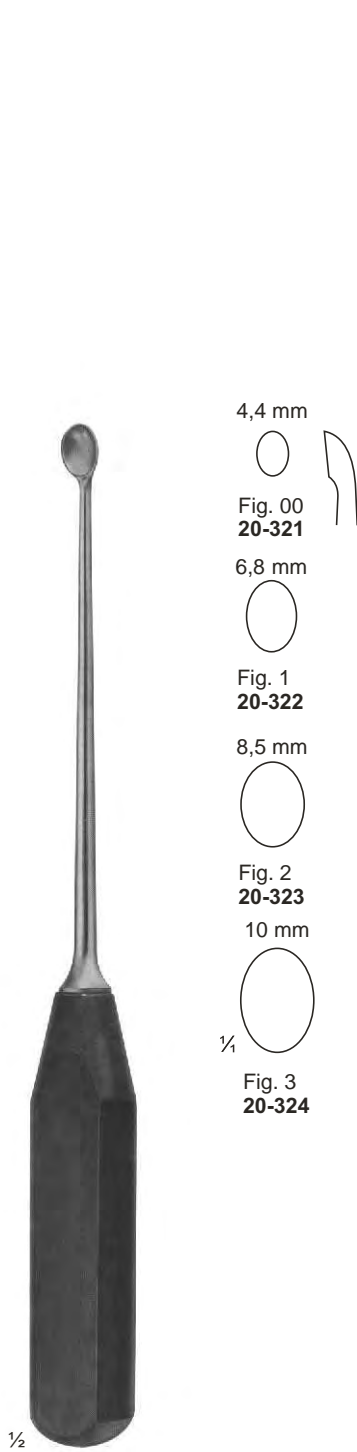

**20-321 - 324**  
270 mm

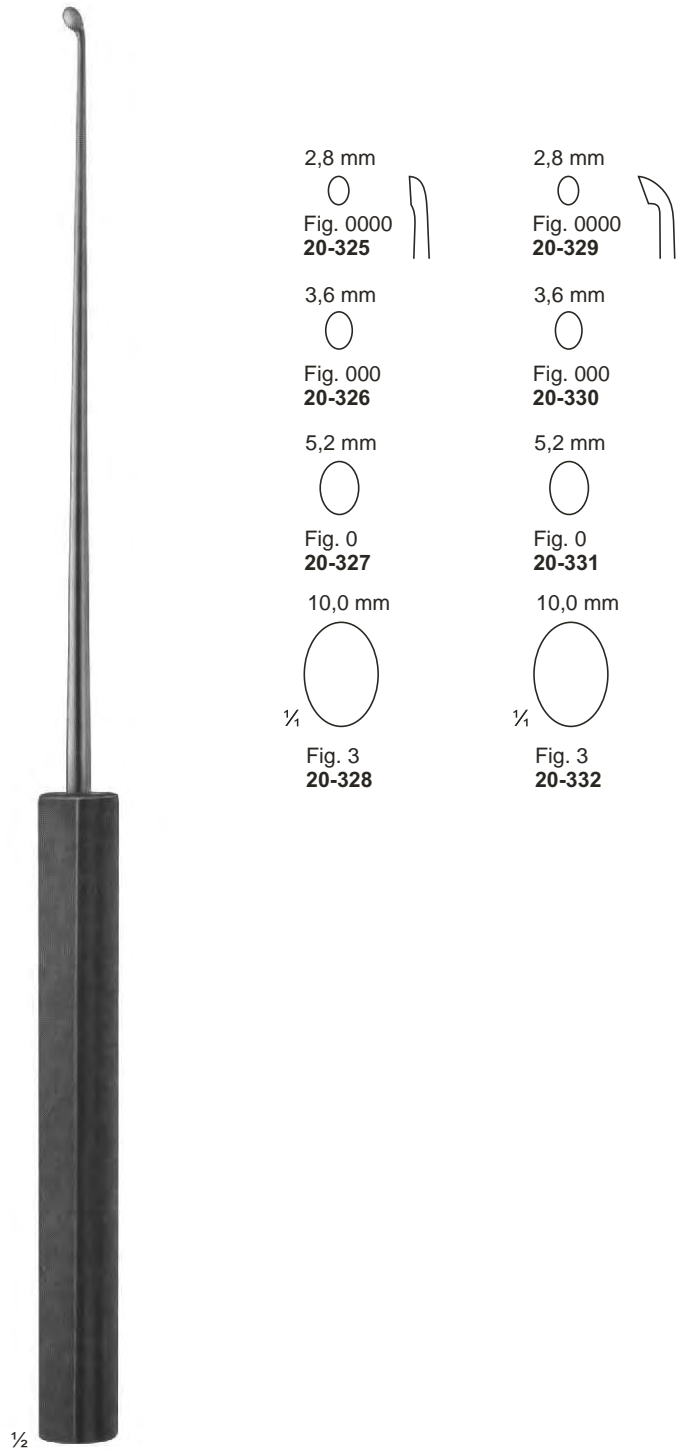

**20-325 - 332**  
SYPERT  
380 mm



∅20 mm

½

**21-101**  
MEAD  
185 g  
with interchangeable  
plastic disks  
190 mm  
**21-102**  
pair of spare disks



½

**21-103**  
140 g  
with interchangeable  
plastic disks  
185 mm  
**21-104**  
pair of spare disks



∅25 mm

½

**21-105**  
COTTLE  
140 g  
1 Seite convex  
1 Side convex  
185 mm



∅22 mm

½

**21-106**  
165 g  
lead filled head  
190 mm



**21-107**  
HAJEK  
140 g  
215 mm



**21-108**  
215 g  
with interchangeable  
plastic disks  
245 mm  
**21-109**  
pair of spare disks



**21-110 - 113**  
WAGNER  
complete with:  
1 pair of metal disks and  
1 pair of plastic disks and  
1 wrench 566  
235 mm

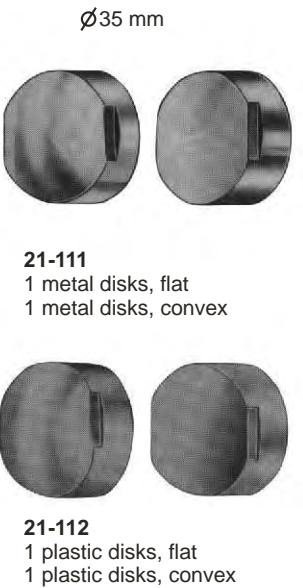

**21-111**  
1 metal disks, flat  
1 metal disks, convex

**21-112**  
1 plastic disks, flat  
1 plastic disks, convex

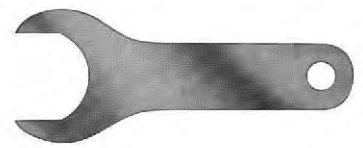

**21-113**  
Wrench

Mallet without disks 130 g



21-114  
BERGMANN  
245 mm



21-115  
BERGMANN  
235 mm



21-116  
OMBREDANNE  
240 mm

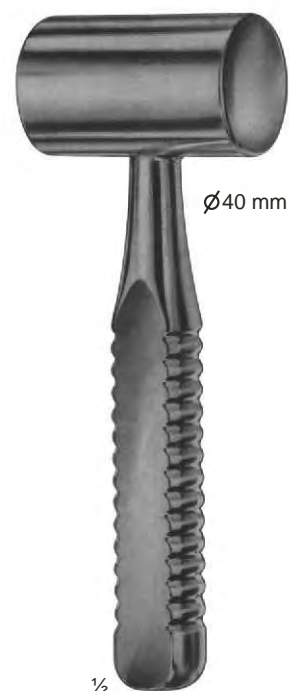

21-117  
HEATH  
copper filled head  
700 g  
185 mm

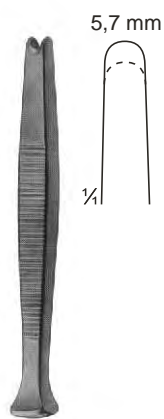

**21-118**  
Haase  
100 mm



**21-119 - 120**  
PASSOW  
120 mm



**21-121 - 123**  
CASPER  
200 mm

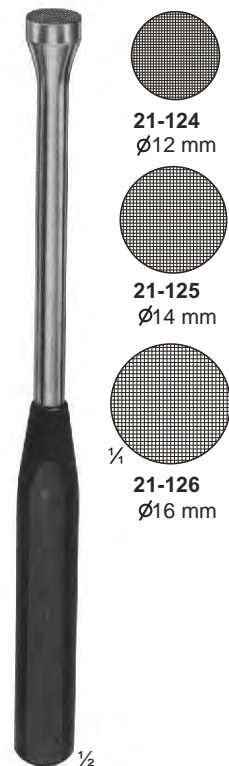

**21-124 - 126**  
200 mm



**21-127**  
FREER  
Chisel  
160 mm

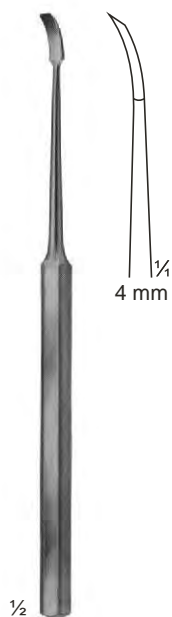

**21-128**  
FREER  
Chisel, curved  
160 mm

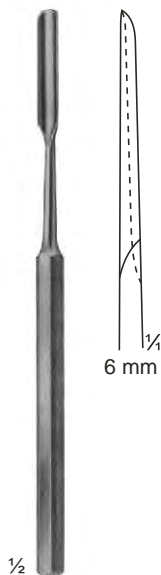

**21-129**  
FREER  
Gouge  
150 mm

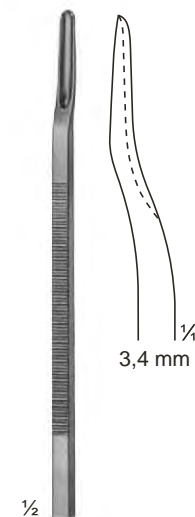

**21-130**  
Scaphoid gouge,  
downwards curved  
135 mm

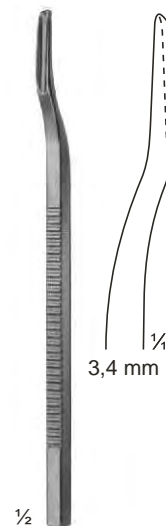

**21-131**  
Scaphoid gouge,  
upwards curved  
135 mm



**21-131A - 133**  
Mannerfelt  
**21-131A** 4 mm  
**21-132** 6 mm  
**21-133** 8 mm  
155 mm



**21-134**  
Mannerfelt  
155 mm

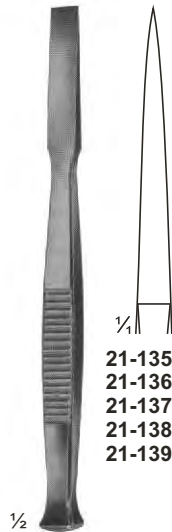

**21-135 - 139**  
Osteotome  
140 mm

- 21-135** 4 mm
- 21-136** 6 mm
- 21-137** 8 mm
- 21-138** 10 mm
- 21-139** 12 mm

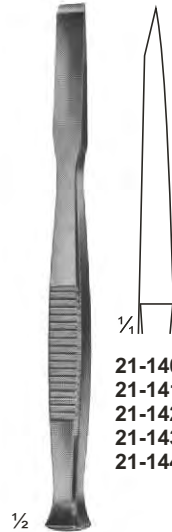

**21-140 - 144**  
Chisels  
140 mm

- 21-140** 4 mm
- 21-141** 6 mm
- 21-142** 8 mm
- 21-143** 10 mm
- 21-144** 12 mm

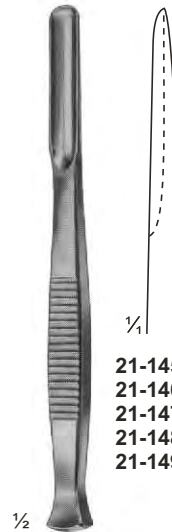

**21-145 - 149**  
Gouges  
140 mm

- 21-145** 4 mm
- 21-146** 6 mm
- 21-147** 8 mm
- 21-148** 10 mm
- 21-149** 12 mm

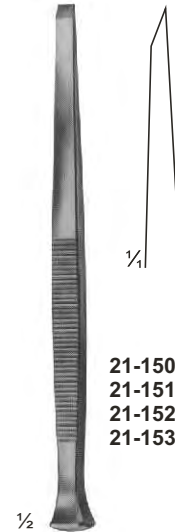

**PARTSCH**  
**21-150 - 153**  
Chisels  
140 mm

- 21-150** 3 mm
- 21-151** 4 mm
- 21-152** 5 mm
- 21-153** 6 mm

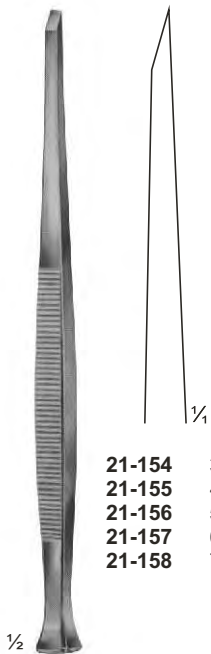

**PARTSCH**  
**21-154 - 158**  
Chisels  
170 mm

- 21-154** 3 mm
- 21-155** 4 mm
- 21-156** 5 mm
- 21-157** 6 mm
- 21-158** 7 mm

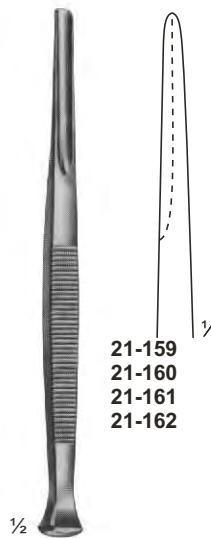

**PARTSCH**  
**21-159 - 162**  
Gouges  
140 mm

- 21-159** 3 mm
- 21-160** 4 mm
- 21-161** 5 mm
- 21-162** 6 mm

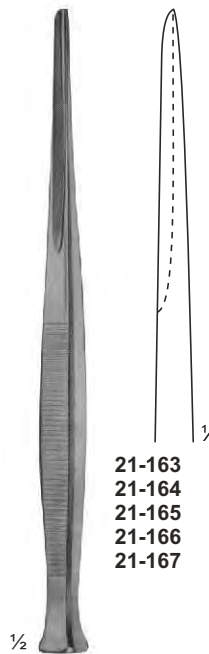

**PARTSCH**  
**21-163 - 167**  
Gouges  
170 mm

- 21-163** 3 mm
- 21-164** 4 mm
- 21-165** 5 mm
- 21-166** 6 mm
- 21-167** 7 mm



**LUCAS**  
**21-168 - 169**  
Chisels  
160 mm

- 21-168** 4 mm
- 21-169** 6 mm

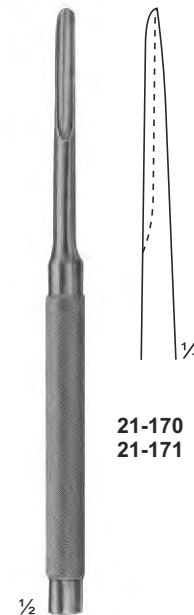

**LUCAS**  
**21-170 - 171**  
Gouges  
160 mm

- 21-170** 3 mm
- 21-171** 5 mm

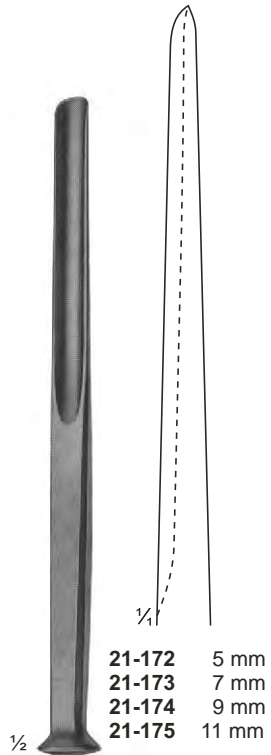

**ALEXANDER**  
21-172 - 175  
Gouges  
170 mm

21-172 5 mm  
21-173 7 mm  
21-174 9 mm  
21-175 11 mm

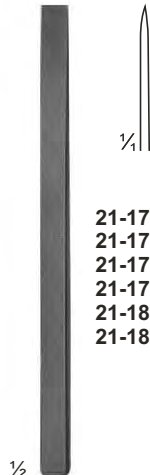

**LAMBOTTE**  
21-176 - 181  
Osteotome  
125 mm

21-176 4 mm  
21-177 6 mm  
21-178 8 mm  
21-179 10 mm  
21-180 12 mm  
21-181 15 mm

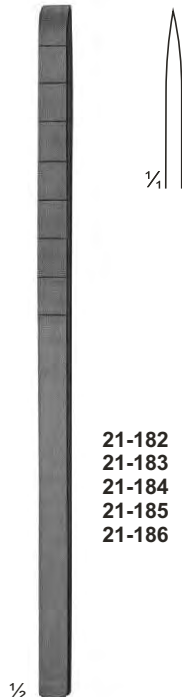

**COTTLE**  
21-182 - 186  
Osteotome with depth  
markings  
180 mm

21-182 4 mm  
21-183 6 mm  
21-184 8 mm  
21-185 10 mm  
21-186 12 mm

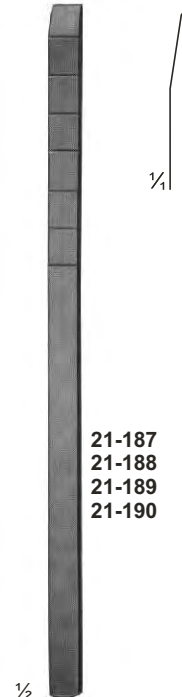

**COTTLE**  
21-187 - 190  
Chisel-Osteotomes  
with depth markings  
180 mm

21-187 4 mm  
21-188 7 mm  
21-189 9 mm  
21-190 12 mm



**COTTLE**  
21-191  
Fishtail Chisel,  
with protected ends  
180 mm

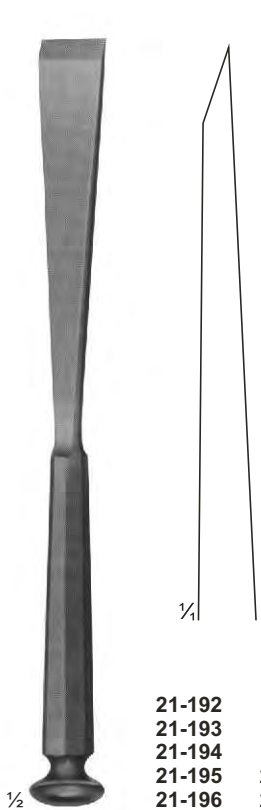

**STILLE**  
21-192 - 196  
Chisels  
205 mm

21-192 10 mm  
21-193 12 mm  
21-194 15 mm  
21-195 20 mm  
21-196 25 mm

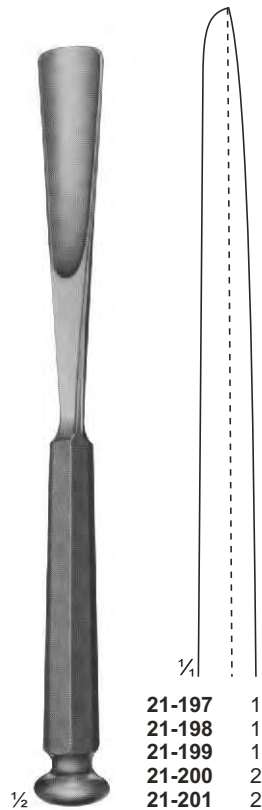

**STILLE**  
21-197 - 201  
Gouges  
205 mm

21-197 10 mm  
21-198 12 mm  
21-199 15 mm  
21-200 20 mm  
21-201 25 mm

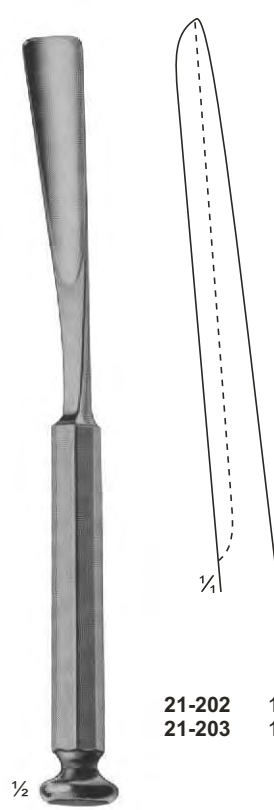

**WALTER**  
21-202 - 203  
Osteotomes  
gouges for taking  
grafts from the rib  
205 mm

21-202 10 mm  
21-203 15 mm



**STILLE**  
21-204 - 208  
Osteotomes  
205 mm

21-204 8 mm  
21-205 12 mm  
21-206 15 mm  
21-207 20 mm  
21-208 25 mm



**STILLE**  
21-209 - 213  
Osteotomes  
205 mm

**STILLE**  
21-214 - 218  
Osteotomes, curved  
205 mm

**LAMBOTTE**  
21-219 - 230  
Osteotomes  
245 mm

**LAMBOTTE**  
21-231 - 236  
Osteotomes, curved  
245 mm

- 21-219 4 mm
- 21-220 8 mm
- 21-221 10 mm
- 21-222 13 mm
- 21-223 15 mm
- 21-224 18 mm
- 21-225 20 mm
- 21-226 25 mm
- 21-227 30 mm
- 21-228 38 mm
- 21-229 44 mm
- 21-230 50 mm

- 21-231 8 mm
- 21-232 13 mm
- 21-233 18 mm
- 21-234 25 mm
- 21-235 30 mm
- 21-236 38 mm

# Osteotomes, Chisels and Gouges with HARTPRESS -handle

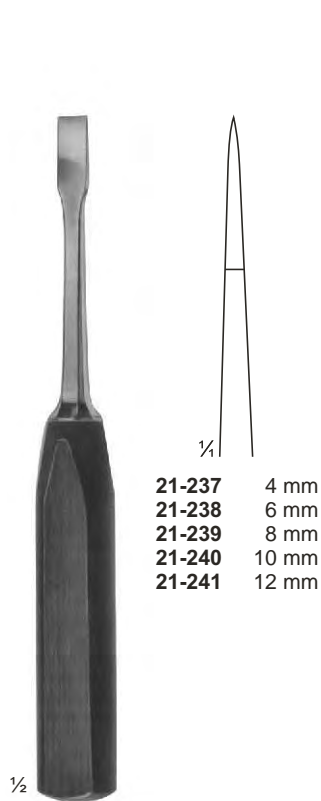

- 21-237 4 mm
- 21-238 6 mm
- 21-239 8 mm
- 21-240 10 mm
- 21-241 12 mm

**LEXER-MINI**  
21-237 - 241  
Osteotomes  
180 mm

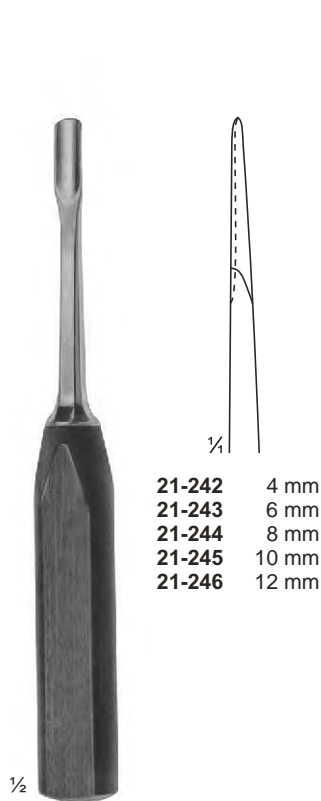

- 21-242 4 mm
- 21-243 6 mm
- 21-244 8 mm
- 21-245 10 mm
- 21-246 12 mm

**LEXER-MINI**  
21-242 - 246  
Gouges  
180 mm

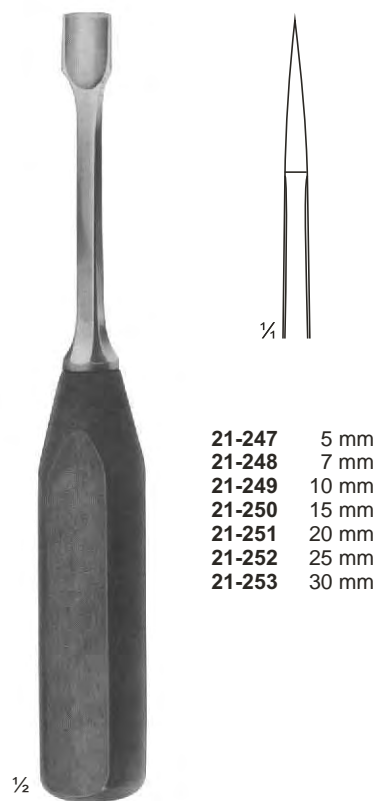

- 21-247 5 mm
- 21-248 7 mm
- 21-249 10 mm
- 21-250 15 mm
- 21-251 20 mm
- 21-252 25 mm
- 21-253 30 mm

**LEXER**  
21-247 - 253  
Osteotomes  
220 mm

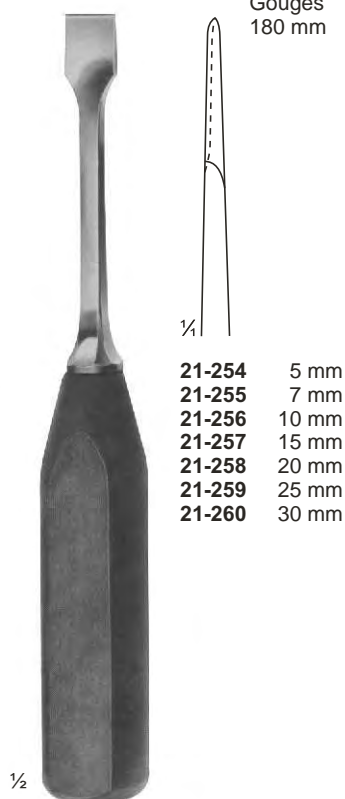

- 21-254 5 mm
- 21-255 7 mm
- 21-256 10 mm
- 21-257 15 mm
- 21-258 20 mm
- 21-259 25 mm
- 21-260 30 mm

**LEXER**  
21-254 - 260  
Gouges  
220 mm

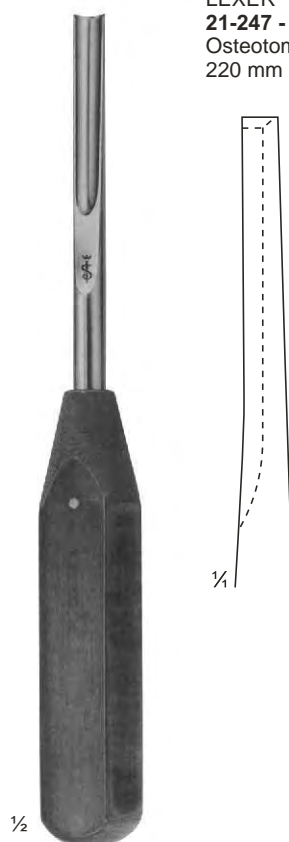

**LEXER**  
21-261  
Gouge for  
removing broken  
screws  
220 mm



- 21-262 5,5 mm
- 21-263 9,0 mm

**ZIELKE**  
21-262 - 263  
Gouge for  
scoliose-operations  
230 mm

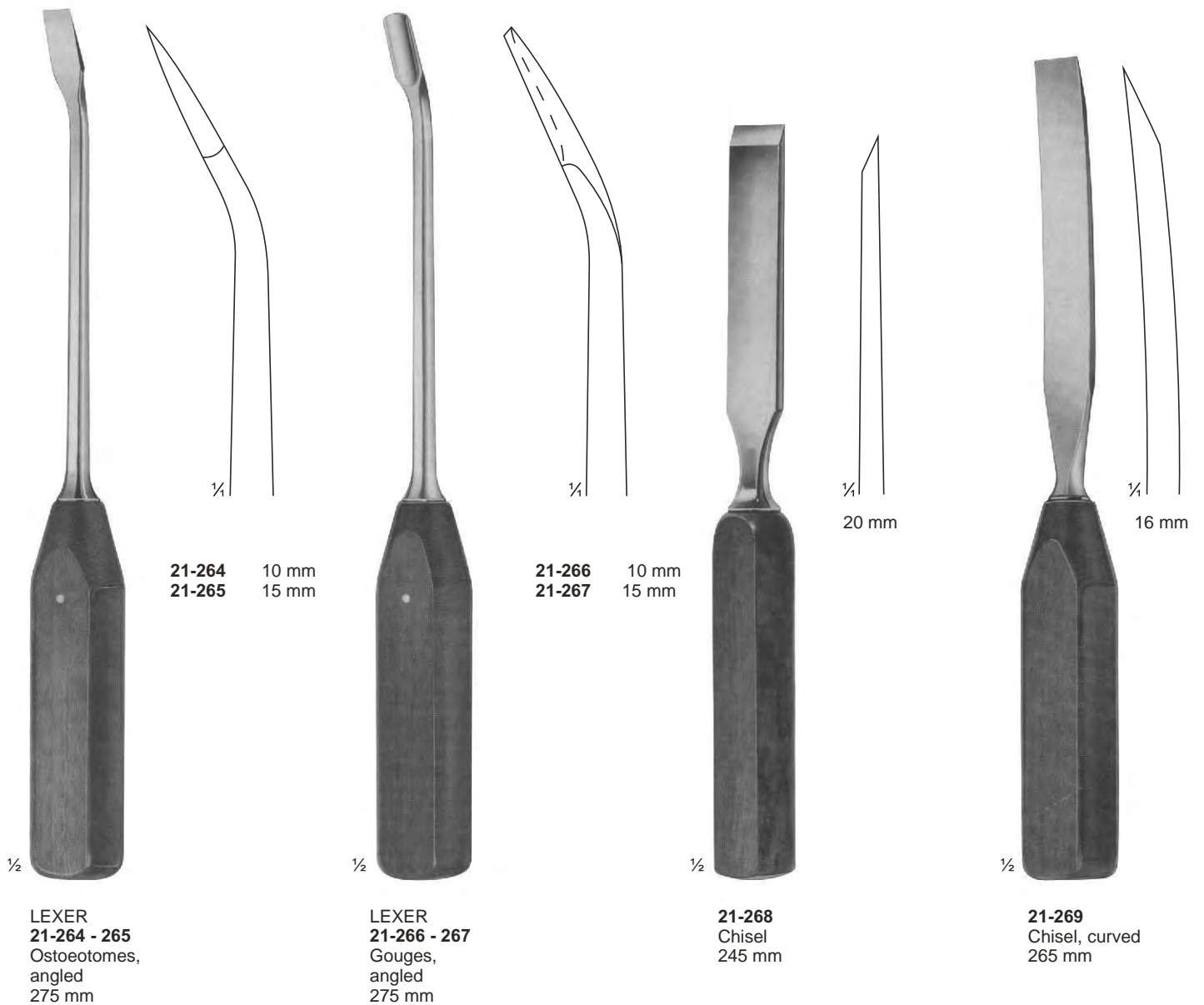



**22-101**  
Reposition forceps,  
for small fragments  
135 mm

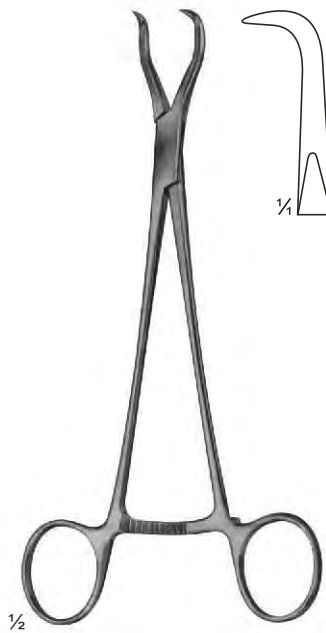

**HAASE**  
**22-102**  
Reposition forceps,  
for mandibular  
fractures  
165 mm

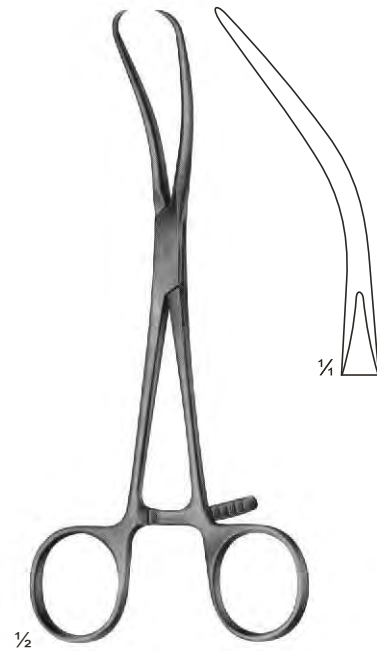

**REILL**  
**22-103**  
Reposition forceps,  
170 mm



**22-104**  
Reposition forceps  
205 mm

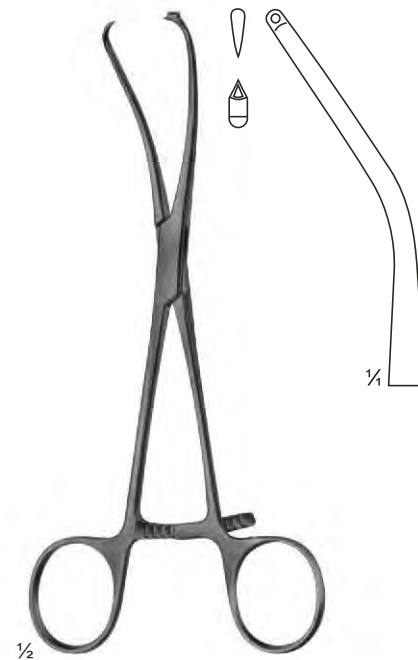
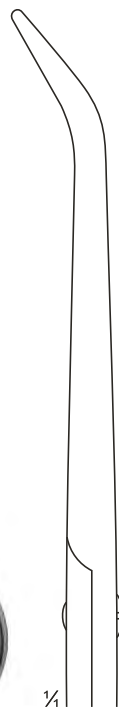

**MEYER**  
**22-105**  
Reposition forceps  
for fingers, with drill  
guide for KIRSCHNER  
wires up to daim.1.0 mm  
170 mm



**22-106**  
Patella forceps  
185 mm



**22-107**  
Forceps with  
ratchet fixation  
140 mm



**22-108**  
Forceps with  
thread fixation  
170 mm



**22-109**  
Forceps with  
thread fixation  
235 mm

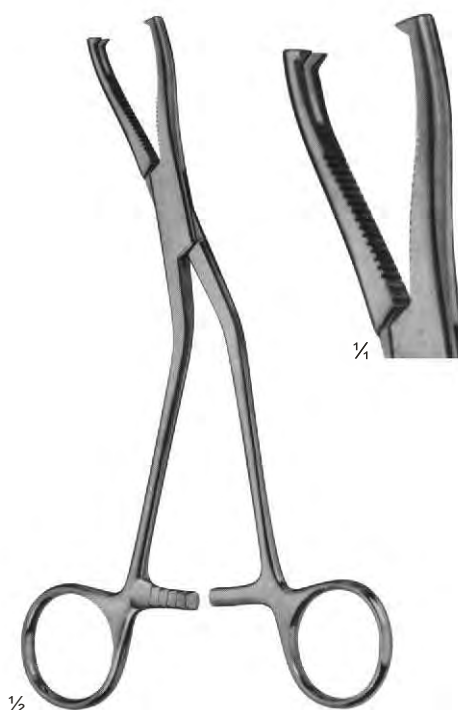

**22-110**  
DINGMANN  
185 mm



**22-111**  
Sequestrum  
forceps  
200 mm



**22-112**  
VAN BUREN  
Sequestrum  
forceps  
225 mm



**22-113**  
LANGENBECK  
Sequestrum  
forceps  
205 mm



**22-114**  
FERGUSON  
205 mm

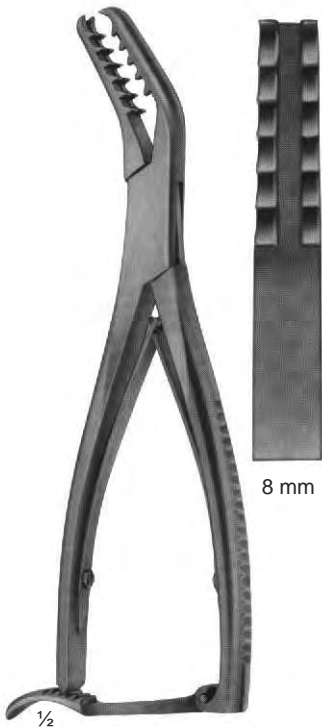
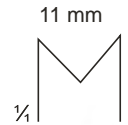
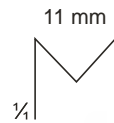
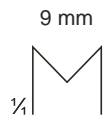
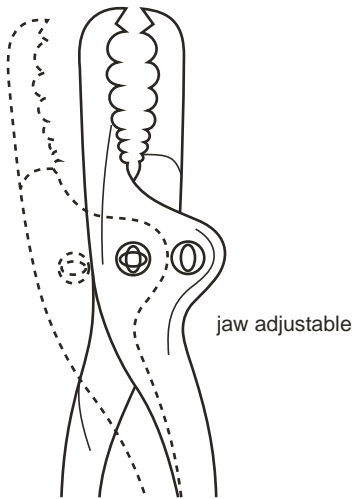

**22-115**  
SEMB  
190 mm



**22-116**  
FARABEUFF  
230 mm



**22-117**  
FARABEUFF  
255 mm



**22-118**  
FARABEUFF-LAMBOTTE  
255 mm







**22-124 - 128**

- 22-124** 145 mm
- 22-125** 190 mm
- 22-126** 240 mm
- 22-127** 260 mm
- 22-128** 280 mm

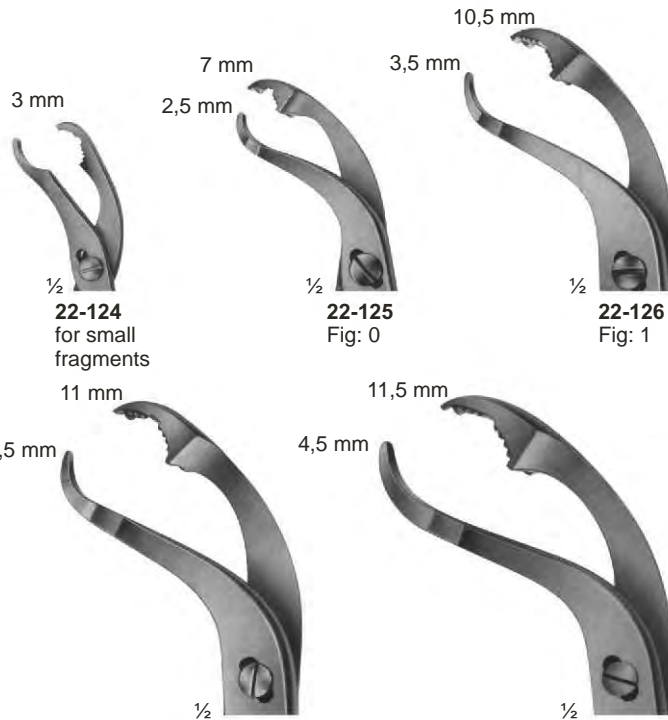

**22-124**  
for small  
fragments

**22-125**  
Fig: 0

**22-126**  
Fig: 1

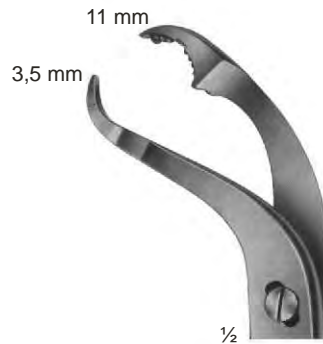

**22-127**  
Fig: 2

**22-128**  
Fig: 3

Self-centering forceps  
with thread fixation



**22-129 - 131**  
VERBRUGGE  
with lip joint

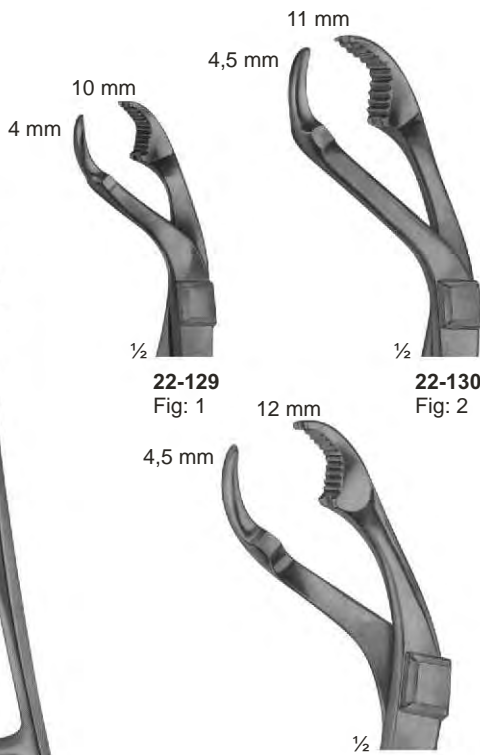

**22-129**  
Fig: 1

**22-130**  
Fig: 2

**22-131**  
Fig: 3



**22-132**  
LAMBOTTE  
265 mm



½  
**22-133 - 134**  
LOWMAN  
22-133 170 mm  
22-134 205 mm



½  
**22-135**  
LOWMAN-GERSTER  
210 mm



½  
**22-136**  
LOWMAN-HOGLUND  
175 mm



**22-137 - 138**  
Synovectomy rongeur  
width of jaws 1.2 mm  
130 mm



**22-139 - 140**  
Synovectomy rongeur  
width of jaws 2.0 mm  
130 mm



**22-141**  
**STELLBRINK**  
Synovectomy rongeur  
175 mm



**22-142**  
**STELLBRINK**  
Synovectomy rongeur  
170 mm



**22-143**  
**LURE-FRIEDMANN**  
145 mm

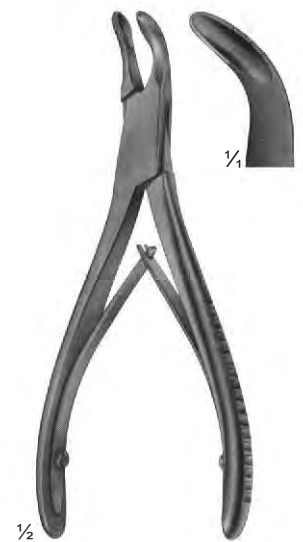

**22-144**  
140 mm



**22-145**  
LURE  
150 mm

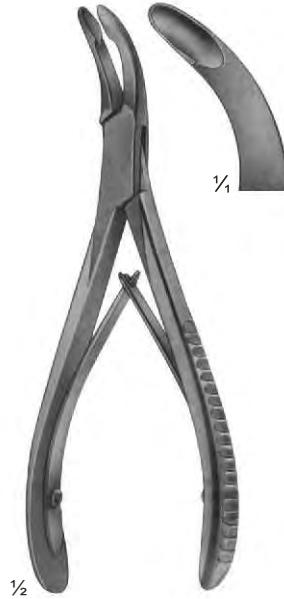

**22-146**  
LURE  
155 mm

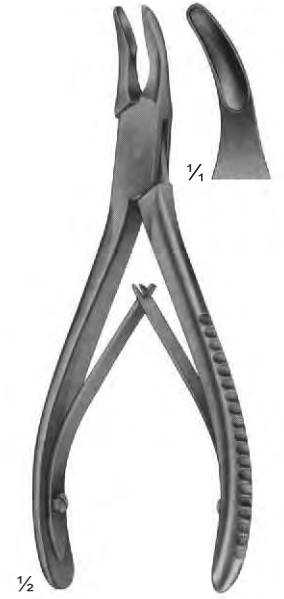

**22-147**  
BLUMENTHAL  
155 mm



**22-148**  
BLUMENTHAL  
150 mm



**22-149 - 150**  
JANSEN  
175 mm

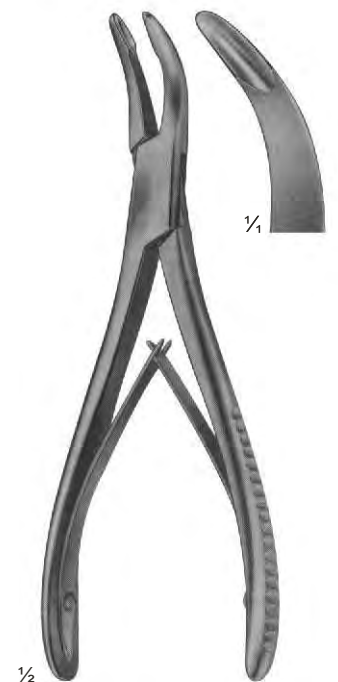

**22-151**  
BANE-HARTMANN  
175 mm



**22-152**  
ALEXANDER  
140 mm

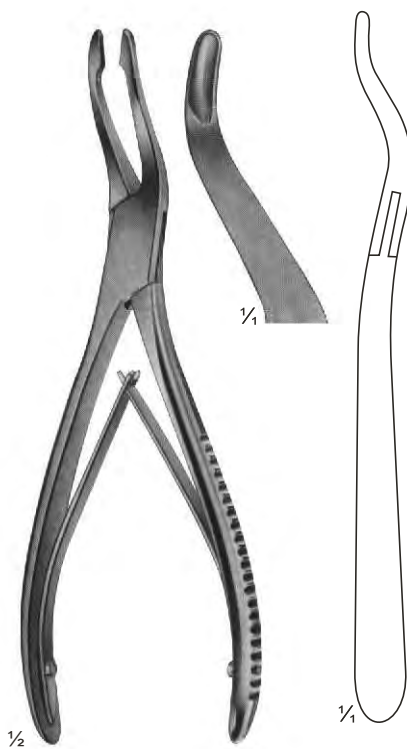

**22-153**  
JANSEN  
190 mm

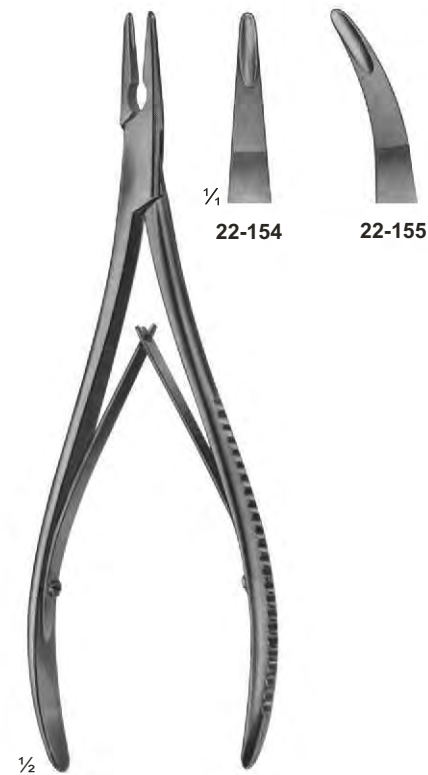

**22-154 - 155**  
LEMPERT  
200 mm

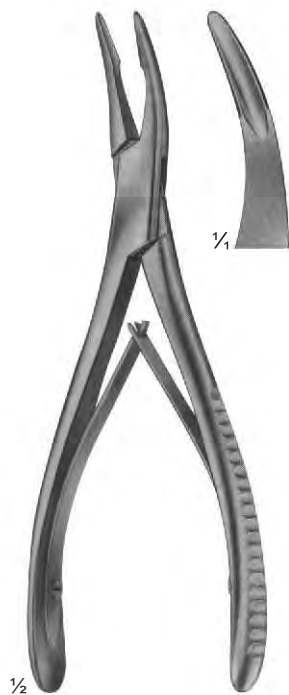

**22-156**  
BEYER  
180 mm

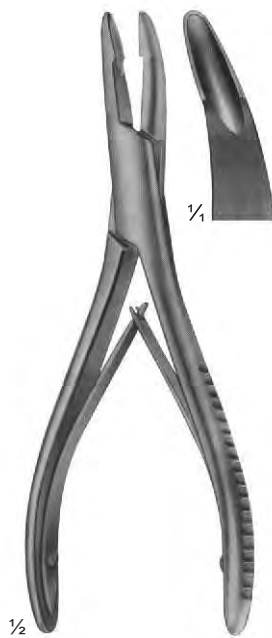

**22-157**  
MEAD  
165 mm

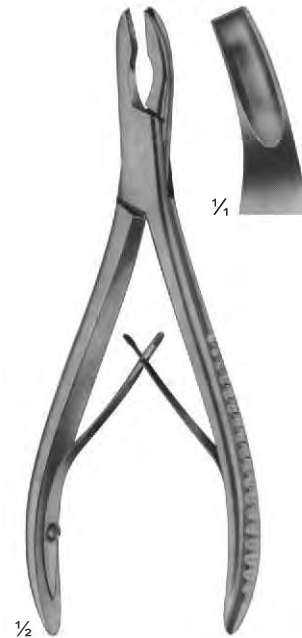

**22-158**  
MEAD  
165 mm

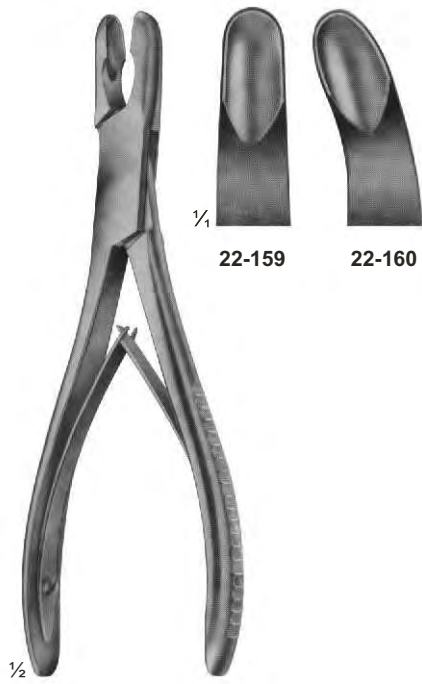

22-159 22-160

**22-159 - 160**  
LURE  
175 mm

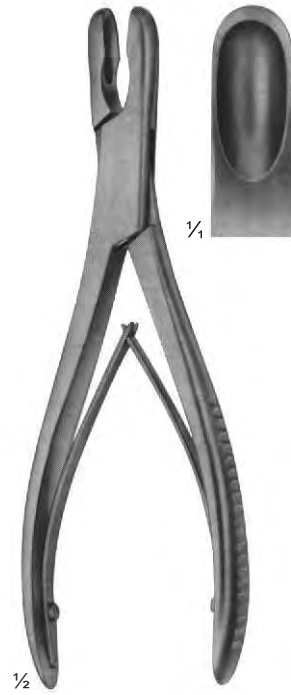

**22-161**  
LURE  
180 mm



**22-162**  
LURE  
180 mm

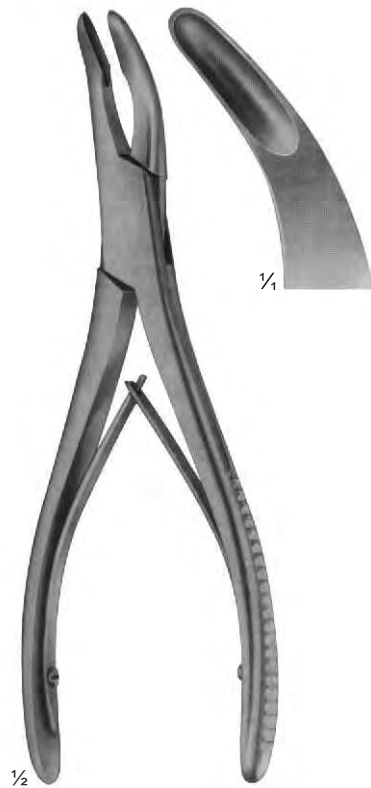

**22-163**  
OLIVECRONA  
205 mm



**22-164 - 165**  
BOHLER  
155 mm



**22-166**  
MARQUARTD  
200 mm



1/2  
**22-167**  
RUSKIN  
190 mm



1/2  
**22-168**  
ROTTGEN-RUSKIN  
240 mm



1/2  
**22-169 - 170**  
ECHLIN  
230 mm



**22-171**  
STILLE  
235 mm



**22-172**  
LEKSELL-STILLE  
240mm



**22-173**  
STILLE-RUSKIN  
240mm



**22-174**  
LURE-STILLE  
225 mm



**22-175**  
LURE-STILLE  
225 mm

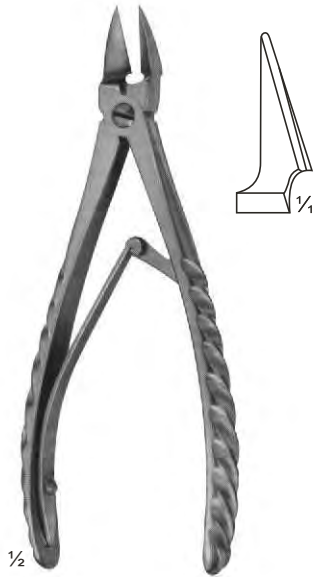

**22-178**  
STAMM  
150 mm



**22-179**  
KAZANJIAN  
185 mm



**22-180 - 183**  
LISTON



**22-180**  
140 mm



**22-181**  
170 mm



**22-182**  
200 mm



**22-183**  
220 mm



**22-184 - 186**  
LISTON



**22-184**  
170 mm

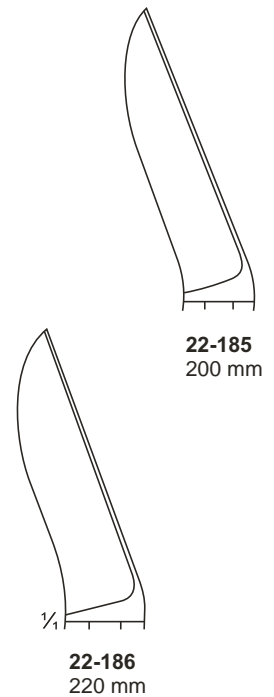

**22-185**  
200 mm



**22-186**  
220 mm



**22-187**  
BOHLER  
145 mm

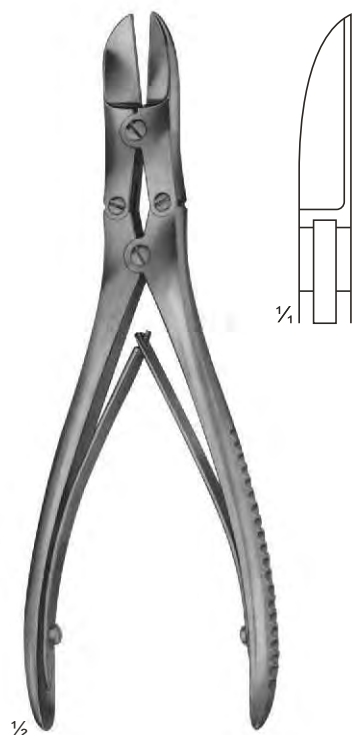

**22-188**  
RUSKIN-LISTON  
190 mm



**22-189**  
RUSKIN-LISTON  
190 mm

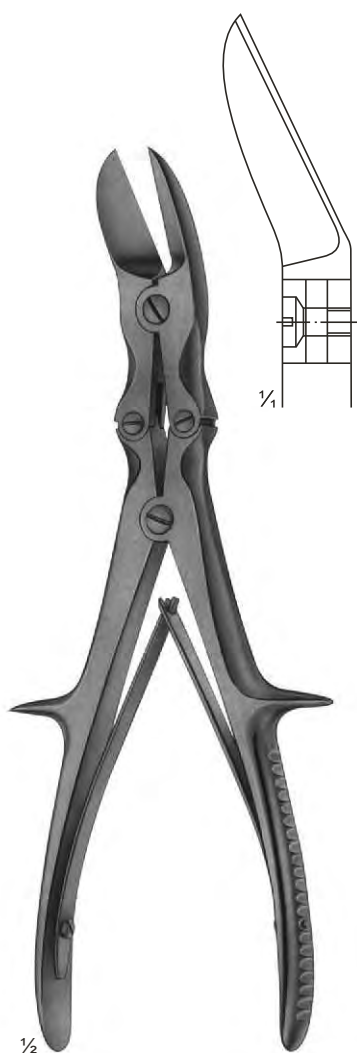

**22-190**  
LISTON  
curved on flat  
240 mm

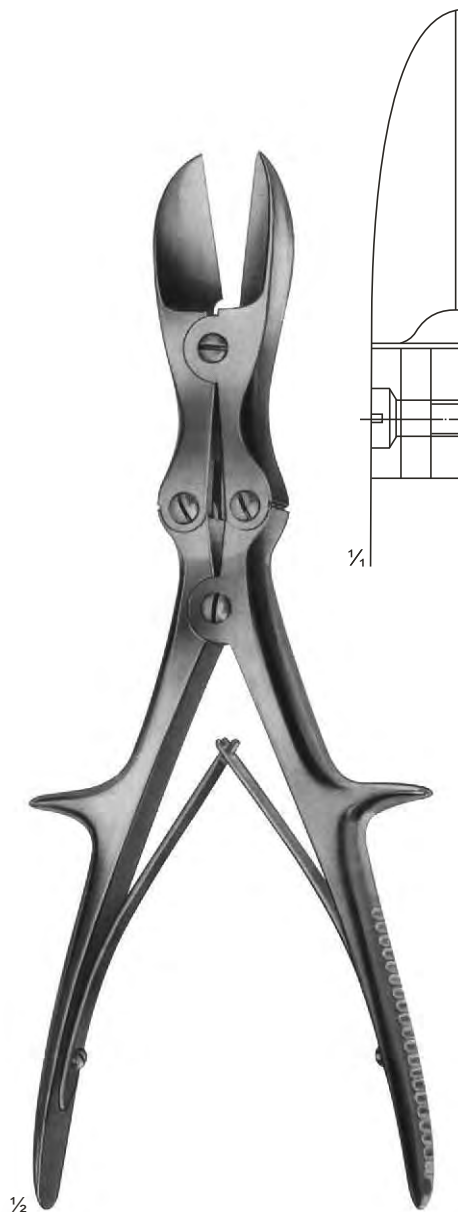

**22-191**  
LISTON  
straight  
280 mm

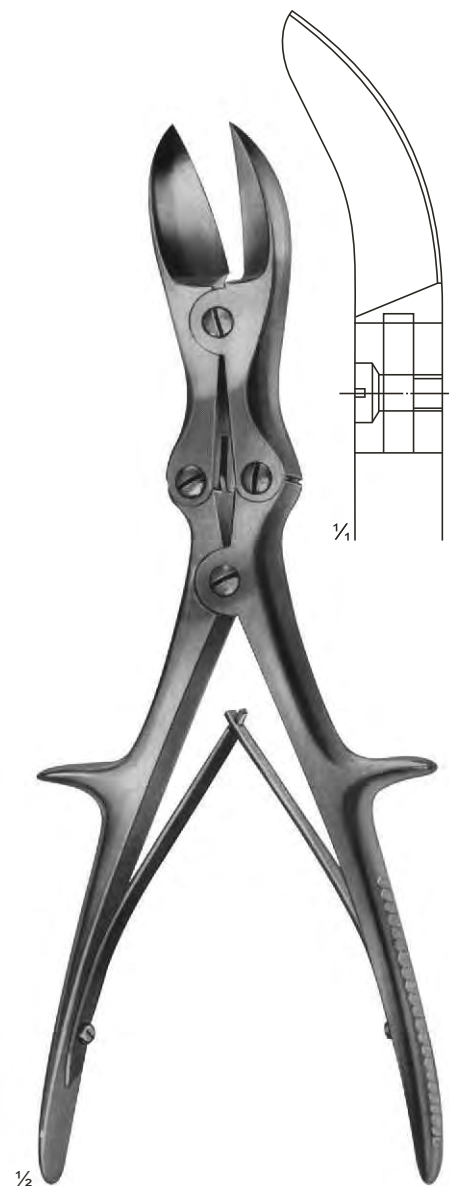

**22-192**  
LISTON  
curved on flat  
280 mm

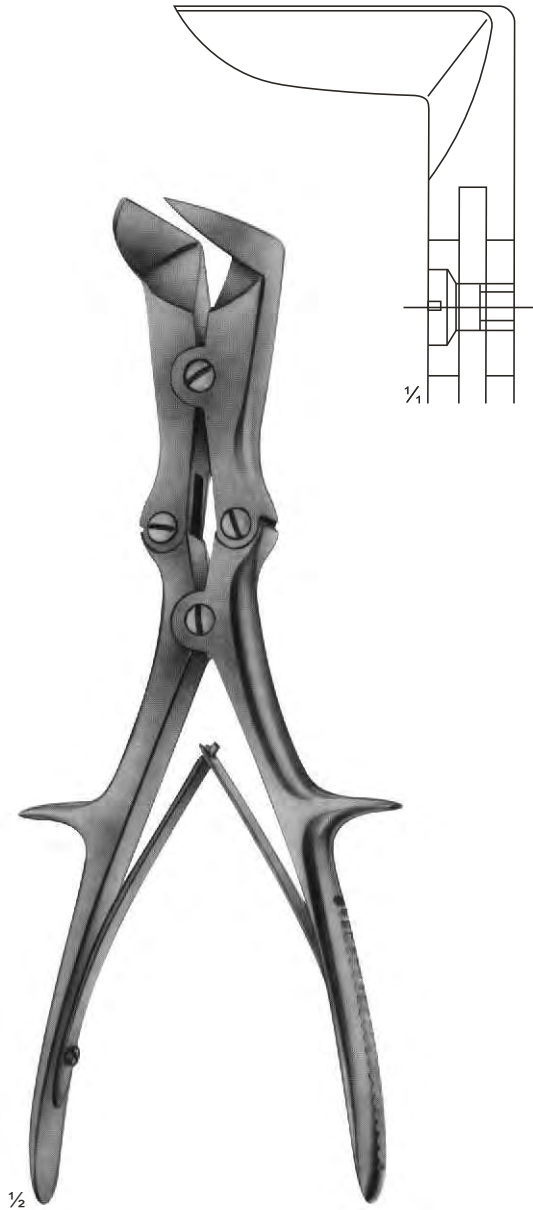

**22-193**  
LISTON-STILLE  
265 mm

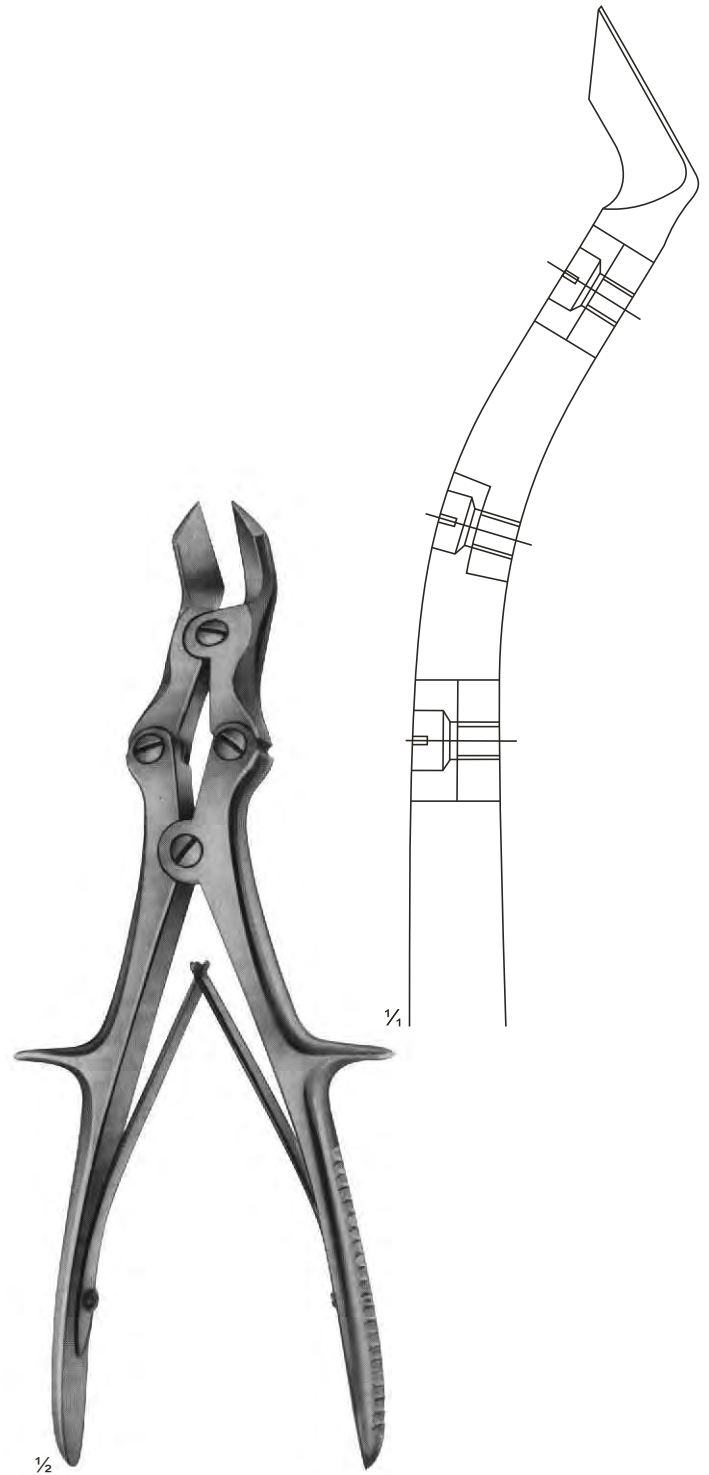

**22-194**  
LISTON-KEY-HORSLEY  
(TUDOR EDWARDS)  
255 mm



**22-195**  
BIRCHER  
200 mm



**22-196**  
BIRCHER  
200 mm

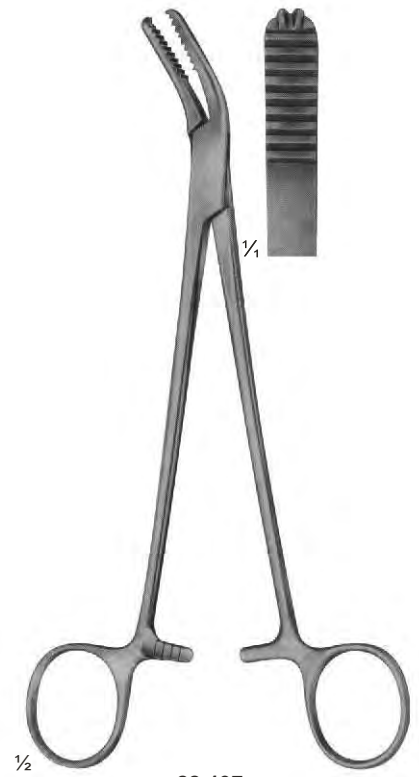

**22-197**  
WELLER  
200 mm

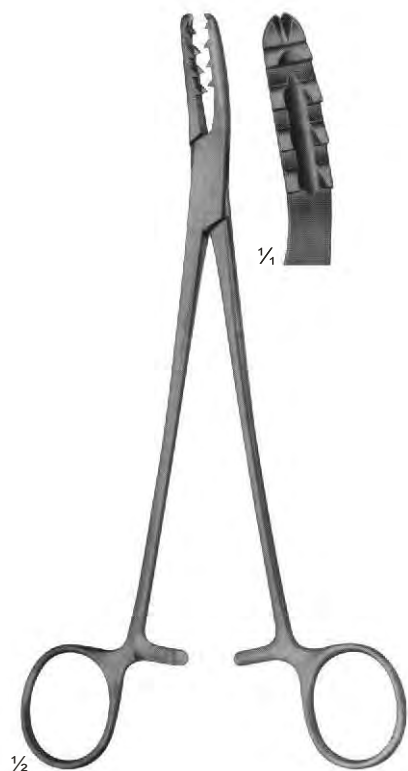

**22-198**  
BIRCHER-GANSKE  
200 mm

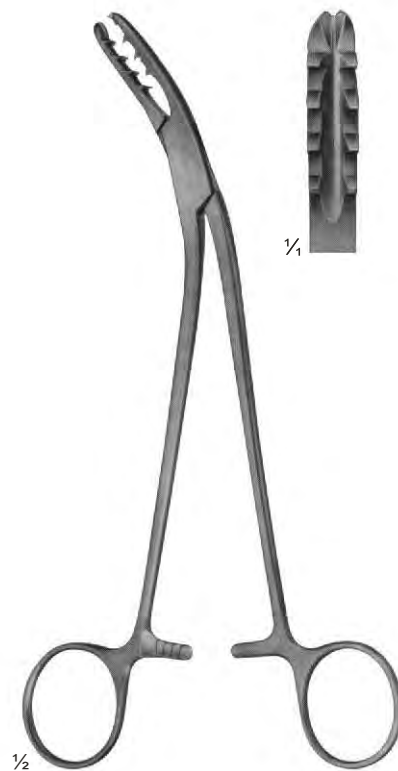

**22-199**  
BIRCHER-GANSKE  
200 mm



**22-200**  
MARTIN  
205 mm

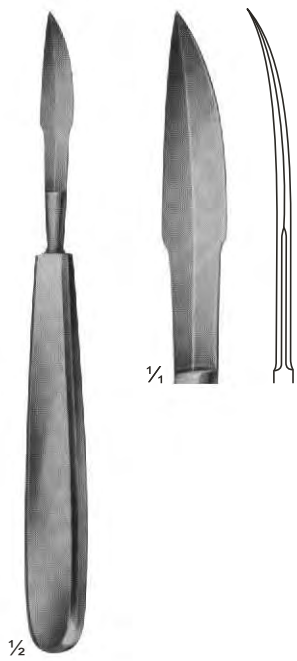

22-201  
170 mm

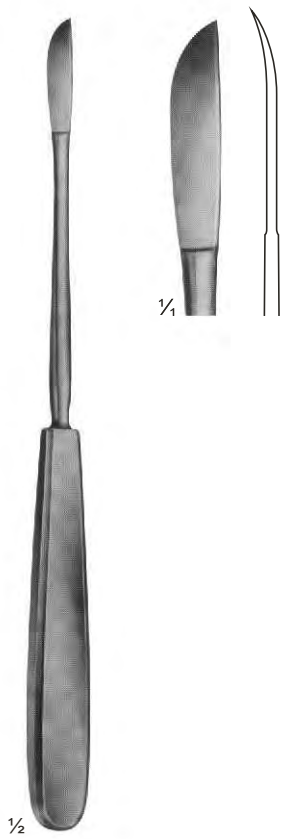

22-202  
NEFF  
215 mm

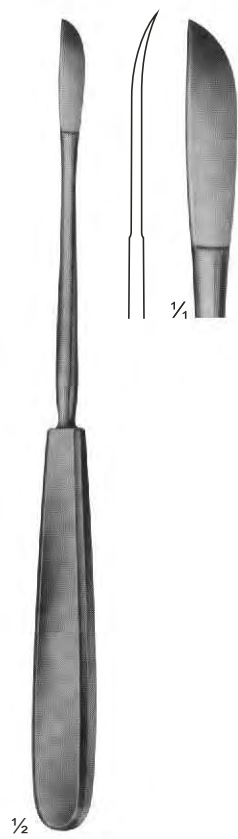

22-203  
NEFF  
215 mm



22-204  
WAGNER  
215 mm

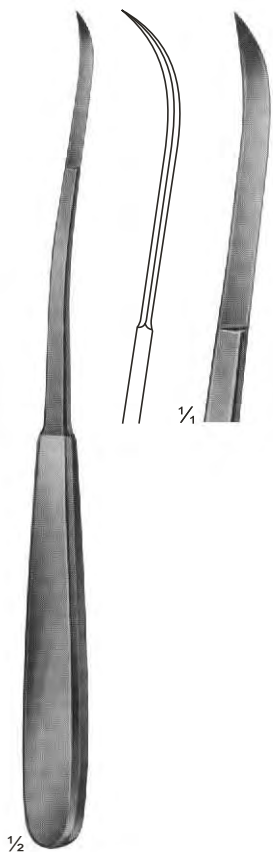

**22-205**  
SALENIUS  
220 mm

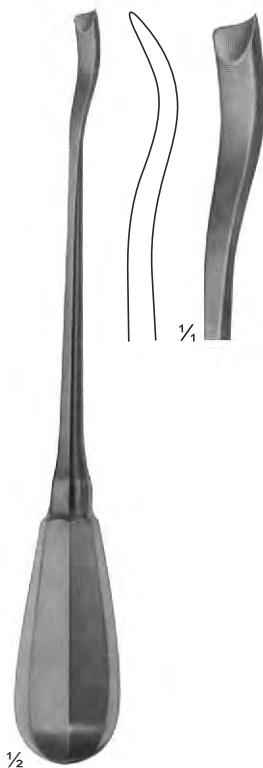

**22-206**  
CHNAD.MODELL  
200 mm

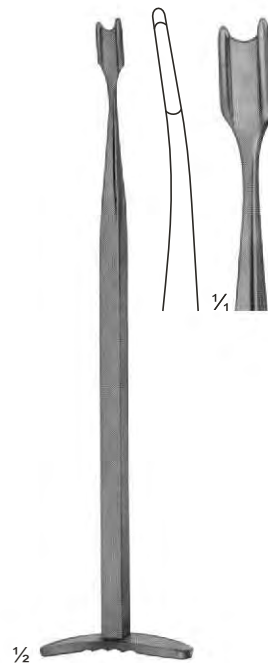

**22-207**  
SMILLIE  
170 mm

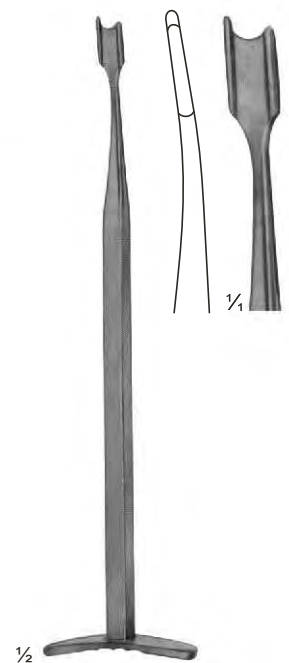

**22-208**  
SMILLIE  
170 mm

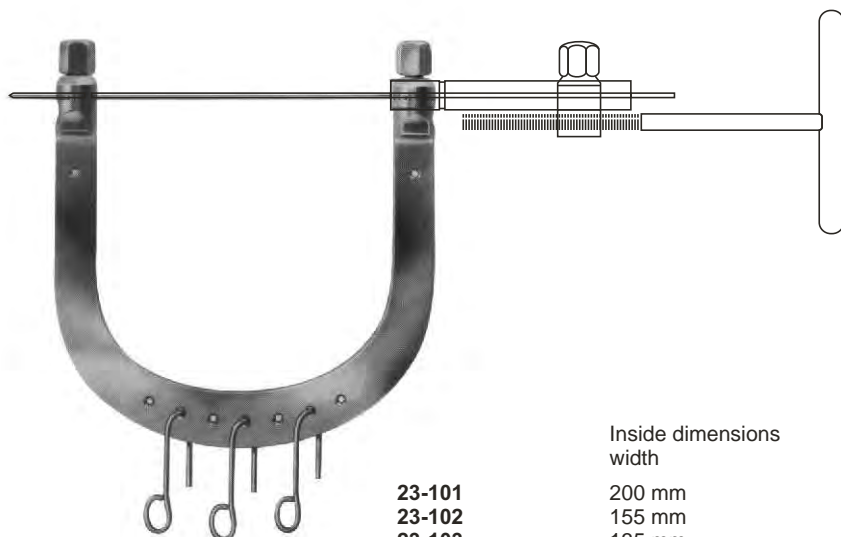

**23-101 - 107**  
KIRSCHNER  
Wire traction bows,  
to be used with  
KIRSCHNER-wires  
up to 2.5 mm diam.,  
With 3 hooks,  
stainless steel

	Inside dimensions width	depth
<b>23-101</b>	200 mm	155 mm
<b>23-102</b>	155 mm	155 mm
<b>23-103</b>	135 mm	130 mm
<b>23-104</b>	120 mm	120 mm
<b>23-105</b>	105 mm	100 mm
<b>23-106</b>	95 mm	110 mm
<b>23-107</b>	95 mm	70 mm



**23-108**  
Wrench, double - ended,  
for wire traction bows



**23-109**  
Wire tightener, with  
clamping jaws



1/3

**23-110**  
Traction hook only,  
large size



1/3

**23-111**  
Traction hook only,  
small size



1/3

**23-112**  
Fixation clamp, to secure clamping  
jaws of stainless steel

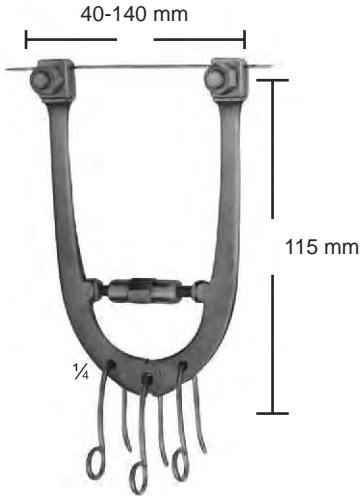

**23-113**  
Wire traction bow, adjustable, with 3 hooks, small size

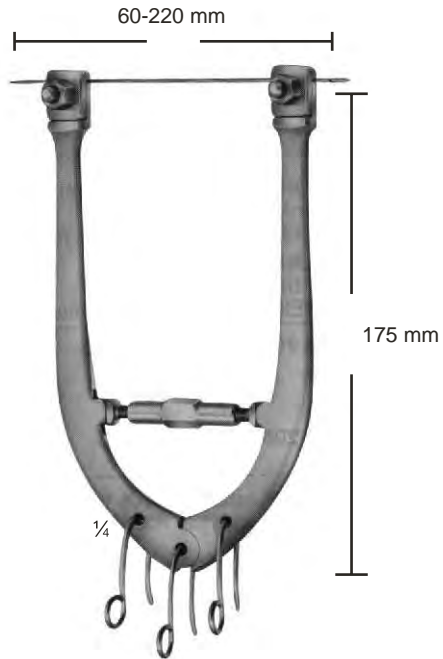

**23-114**  
Wire traction bow, adjustable, with 3 hooks, large size

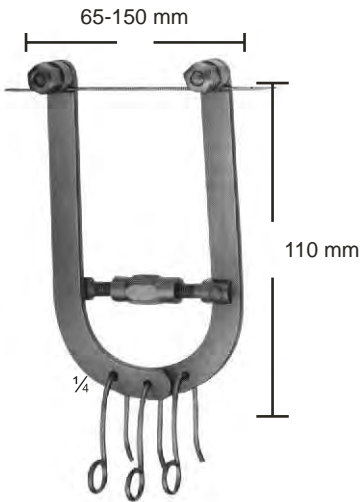

**23-115**  
Wire traction bow, adjustable, with 3 hooks, large size for elbow and calcaneus, for adolescents



<b>23-116</b>	105 mm
<b>23-117</b>	160 mm
<b>23-118</b>	200 mm
<b>23-116</b>	1,6 mm
<b>23-117</b>	2,0 mm
<b>23-118</b>	2,5 mm

**23-116 - 118**  
**KIRSCHNER**  
Wire traction bow, modified adjustable in with width, holds wire securely, with 1 hook



**23-119**  
Fixation disc, slotted



**23-120**  
idem, aluminum, transparent to X-rays



**23-121**  
Fixation disc, slotted



**23-122**  
Screw driver, for above fixations discs

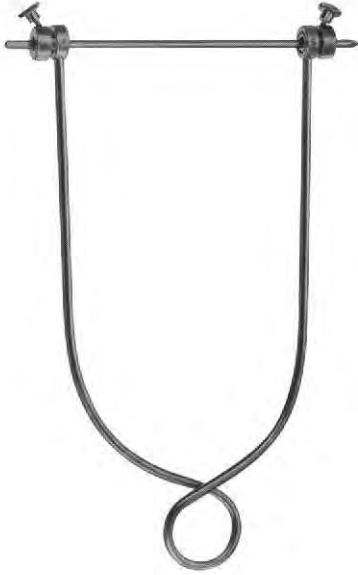

**23-123 - 130**  
Screw driver, for above fixations discs

Steinmann pins, 4 mm daim.		Steinmann pins, 5 mm daim.	
<b>23-123</b>	with pin		16x9cm Arm
<b>23-124</b>	without pin	<b>23-129</b>	without
<b>23-125</b>	with pin		21x11cm Arm
<b>23-126</b>	without pin	<b>23-130</b>	without
<b>23-127</b>	with pin		21x15cm Arm
<b>23-128</b>	without pin		



**23-131**  
**SCHWARZ**  
Traction bow for fingers,  
to be used with KIRSCHNER-  
wire up to 1.6 mm diam.



**23-132**  
Small distractor  
as a repositioning device for  
distraction and compression of small bones,  
for wires with 3.0 mm diam.



**23-133 - 147**  
**STEINMANN**  
 triangular shaft ended and trocar point

Length	4,0 mm	5,0 mm
80 mm	<b>23-133</b>	
100 mm	<b>23-134</b>	
120 mm	<b>23-135</b>	
140 mm	<b>23-136</b>	
150 mm	<b>23-137</b>	<b>23-143</b>
160 mm	<b>23-138</b>	
180 mm	<b>23-139</b>	<b>23-144</b>
200 mm	<b>23-140</b>	<b>23-145</b>
210 mm	<b>23-141</b>	
250 mm	<b>23-142</b>	<b>23-146</b>
300 mm		<b>23-147</b>



1/4

**23-148**  
 Protection cap  
 for 4,0 mm STEINMANN Pins



1/4

**23-149**  
 Protection cap  
 for 5,0 mm STEINMANN Pins



**23-150**  
REILL  
Drilling chuck,  
cannulated,  
for shanks from  
2.0 - 2.5 mm diam  
115 mm



**23-151**  
Drilling chuck,  
cannulated,  
for shanks from  
0.8 - 2.0 mm diam  
150 mm



**23-152**  
Drilling chuck,  
cannulated,  
for shanks up to  
4.5 mm diam  
with key  
140 mm



**23-153**  
LOUTE  
Wire tightener, improved pattern,  
with movable tip,  
for wires up to 1.0 mm diam.  
220 mm



**23-154**  
Drilling chuck, cannulated,  
for shanks up to 6.35 mm diam.,  
To be tightened by hand  
100 mm



**23-155**  
Drilling chuck, cannulated,  
for shanks up to 4.5 mm diam.,  
And for triangular shaft width  
across flats 4.7 mm



**23-156**  
Drilling chuck, cannulated,  
for shanks up to 6.35 mm diam.,  
With key  
160 mm

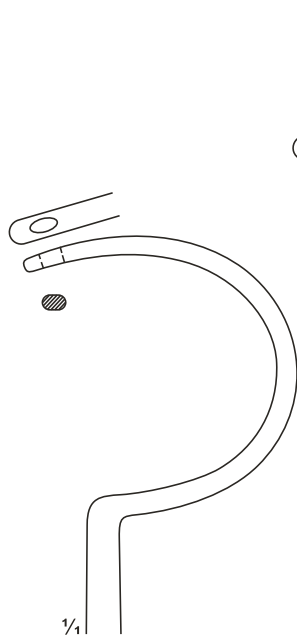

**23-157**  
275 mm

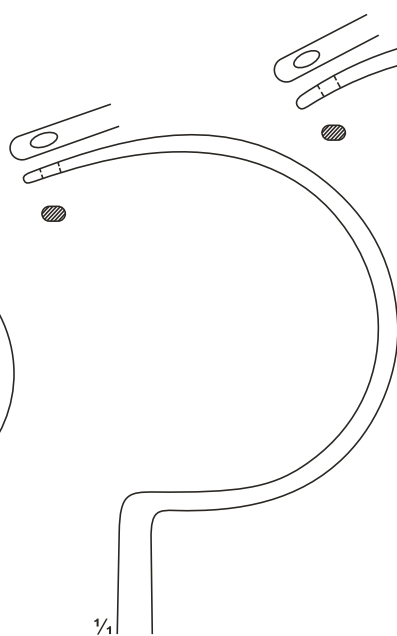

**23-158**  
285 mm

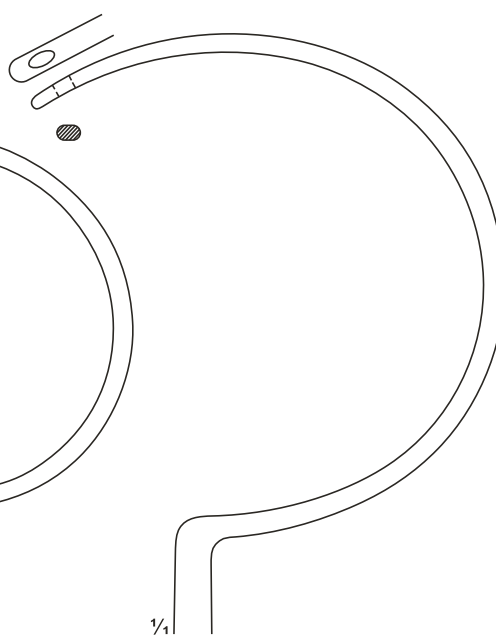

**23-159**  
305 mm



**23-157 - 159**  
DEMEL  
Wire guides

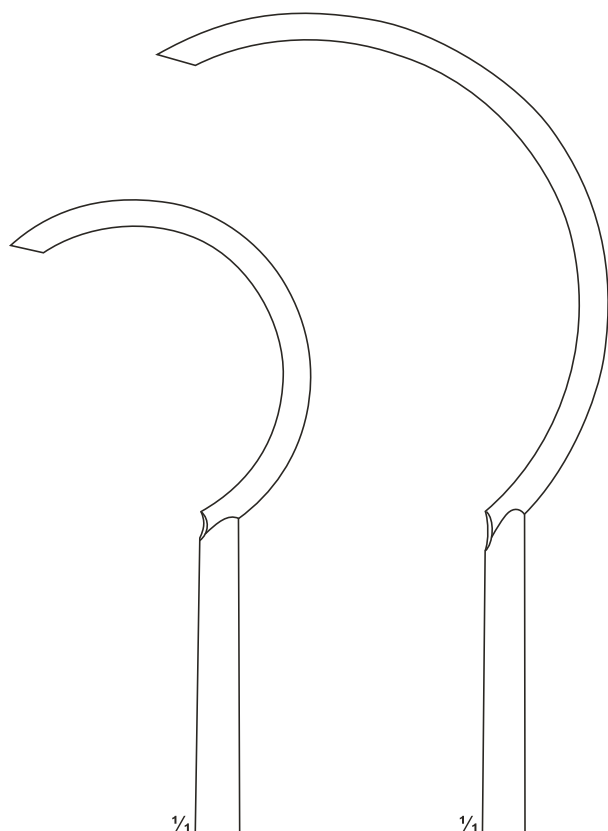

**23-160**  
240 mm



**23-161**  
270 mm

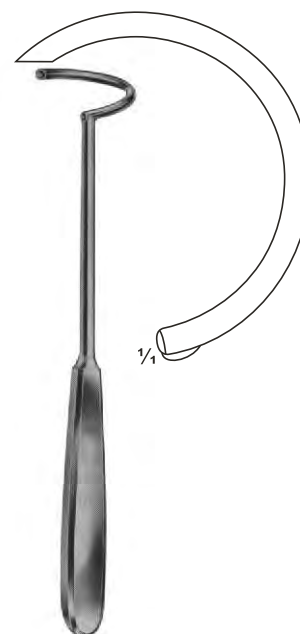

**23-162**  
225 mm



**23-163**  
JORDAN  
Wire tightener



1/2

**23-164**  
JORDAN  
Wire twister  
170 mm



1/2

**23-165**  
JORDAN  
Wire catcher  
180 mm



1/2

**23-166**  
JORDAN  
Probe, cannulated  
170 mm

# Wire Holding forceps, Wire Tightening Pliers, Flat-nosed Pliers



**23-167**  
DUROGRIP  
Holding forceps for cerclage wire, with lateral jaws to avoid wire slipping off  
170 mm



**23-168**  
DUROGRIP  
Wire, tightening pliers, Ligature pliers  
150 mm



**23-169**  
DUROGRIP  
Wire, tightening pliers, Ligature pliers  
150 mm



**23-170**  
with serrated jaws  
140 mm



**23-171**  
one jaws smooth, one jaws serrated  
140 mm



**23-172**  
with serrated jaws  
**23-173**  
with longitudinal and transversal grooves  
170 mm



**23-174**  
190 mm

# Wire Holding forceps, Flat-nosed Pliers, Pliers for bending and cutting wires

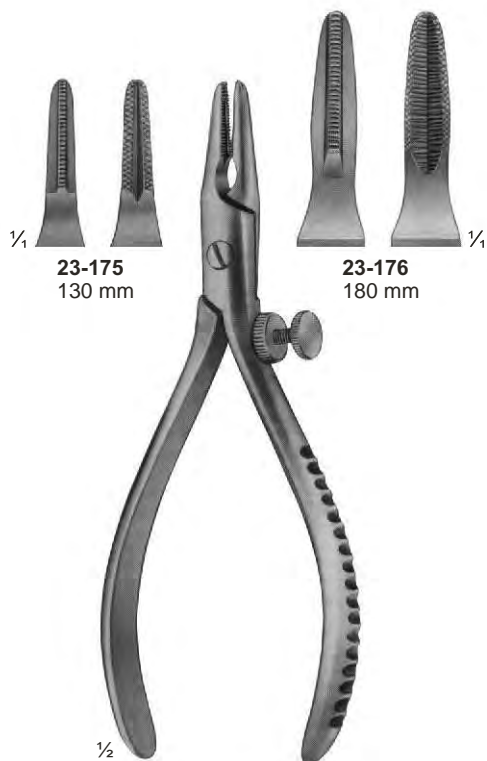

**23-175 - 176**  
Extraction pliers  
for boring wires



**23-177**  
Flat-nosed pliers,  
parallel  
185 mm

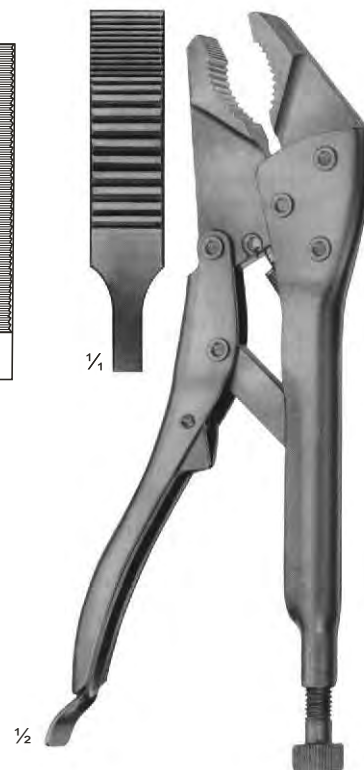

**23-178**  
Vise grip  
200 mm

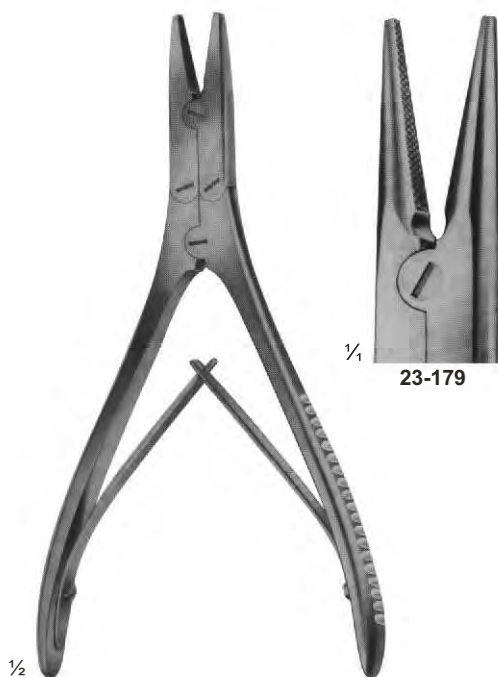

**23-179 - 183**  
Round pliers  
180 mm

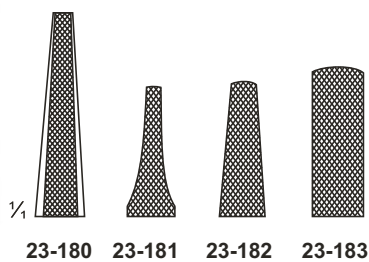

**23-180**  
**23-181** 145 mm  
**23-182** 180 mm  
**23-183** 180 mm  
Extraction pliers for wires

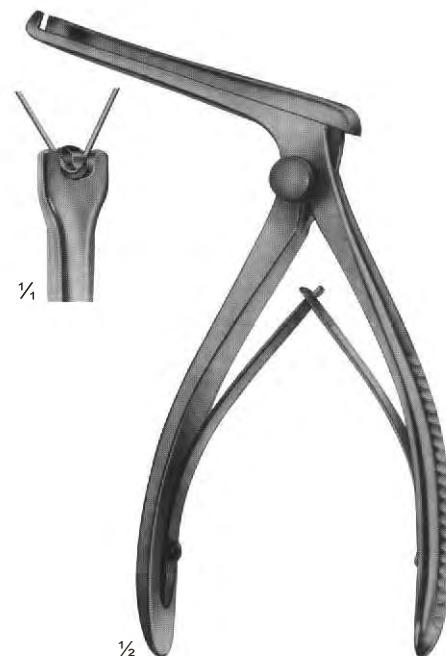

**23-184**  
Bending pliers  
for wires up to  
1.8 mm diam.

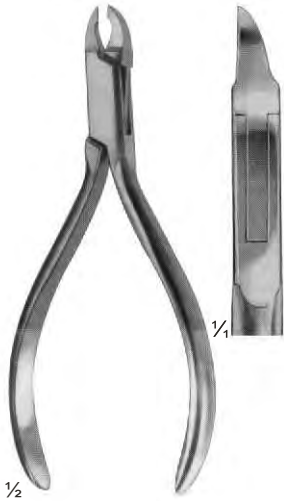

**23-185**  
ANGLE  
130 mm

for soft wire  
up to diam.  
for hard wire  
up to diam.

**23-186**  
DUROTIP  
ANGLE  
130 mm

0,5 mm 0,6 mm  
0,3 mm 0,4 mm

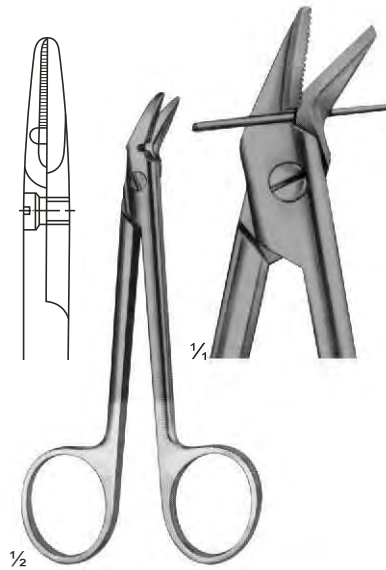

**23-187**  
120 mm

for soft wire  
up to diam.  
for hard wire  
up to diam.

**23-188**  
DUROTIP  
120 mm

1,2 mm 1,2 mm  
0,8 mm 0,8 mm

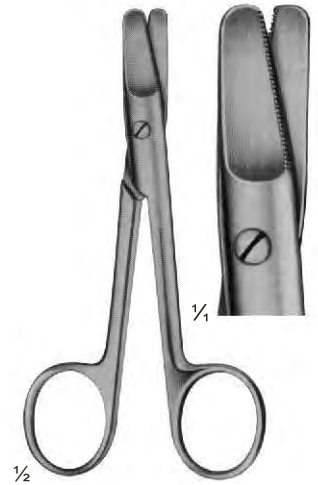

**23-189**  
HARVEY  
125 mm

0,4 mm  
0,3 mm



**23-190**  
150 mm

for soft wire  
up to diam  
for hard wire  
up to diam

1,5 mm  
1,0 mm



**23-191**  
160 mm

1,5 mm  
1,2 mm



**23-192**  
140 mm

1,5 mm  
1,0 mm



**23-193**  
180 mm

for soft wire  
up to diam. 2,0 mm  
For hard wire 1,5 mm  
up to diam  
specially hardened  
cutting edges, front  
and lateral cutting  
action



**23-194**  
REILL  
175 mm

for soft wire  
up to diam. 2,0 mm  
For hard wire 1,6 mm  
up to diam  
specially hardened  
cutting edges, for  
cutting off wires close  
to the bone



**23-195**  
235 mm

for soft wire  
up to diam. 3,0 mm  
For hard wire 2,2 mm  
up to diam

# Wire Cutting Pliers, Lateral and Front Cutting Action

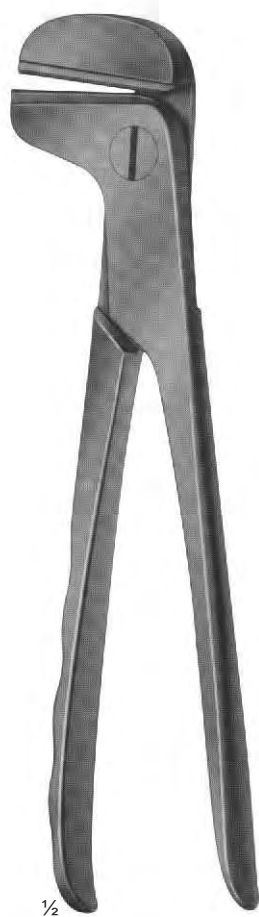

**23-196**  
240 mm

for soft wire  
up to diam.  
For hard wire  
up to diam

2,0 mm  
1,6 mm



**23-197**  
140 mm

for soft wire  
up to diam.  
For hard wire  
up to diam

1,5 mm  
1,0 mm



**23-198**  
145 mm

for soft wire  
up to diam.  
For hard wire  
up to diam

2,0 mm  
1,5 mm



**23-199**  
220 mm

for soft wire  
up to diam.  
For hard wire  
up to diam

3,5 mm  
2,5 mm



1/4

Cutter for cutting off  
KIRSCHNER wires,  
Tibia head screws,  
bolts, pins, up to 3 mm diam.

**23-200**  
320 mm

for soft wire  
up to diam. 3,0 mm  
For hard wire  
up to diam 3,0 mm



Durotip

**23-201**  
Cutter for cutting off  
KIRSCHNER wires,  
Tibia head screws,  
bolts, pins, up to 6 mm diam.  
470 mm

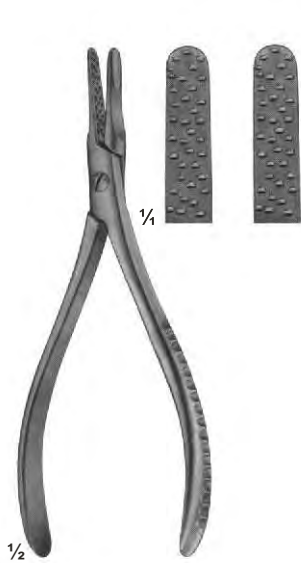

**23-202**  
Nail extracting  
forceps  
135 mm



**23-203**  
Nail extracting  
forceps  
145 mm

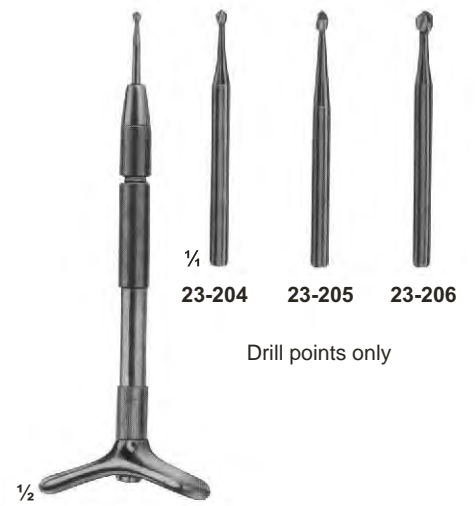

**23-204 - 206**  
Finger nail drill  
with 3 points

Drill points only

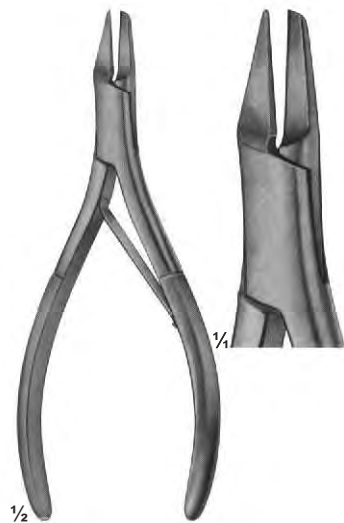

**23-207**  
Nail splitting  
forceps  
135 mm

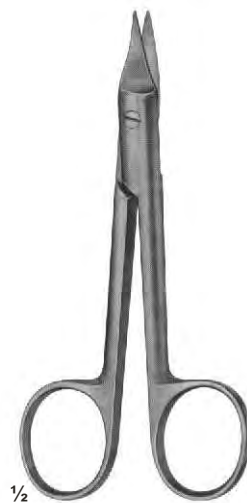

**23-208**  
SYSTRUNK  
Scissors, for splitting  
finger nails  
130 mm



**23-209**  
Finger ring saw  
150 mm

Spare blade



with ebony handle

1/2

**24-101**  
HOPKINS  
200 mm



1/2

**24-102**  
ESMARCH  
180 mm



1/2

**24-103**  
ENGEL  
160 mm



1/2

**24-104 - 112**

- |                     |                           |
|---------------------|---------------------------|
| <b>24-104</b> black | <b>24-108</b> yellow      |
| <b>24-105</b> red   | <b>24-109</b> white       |
| <b>24-106</b> blue  | <b>24-110</b> orange      |
| <b>24-107</b> green | <b>24-111</b> lavender    |
|                     | <b>24-112</b> bright pink |



1/2

**24-113 - 121**

- |                     |                           |
|---------------------|---------------------------|
| <b>24-113</b> black | <b>24-117</b> yellow      |
| <b>24-114</b> red   | <b>24-118</b> white       |
| <b>24-115</b> blue  | <b>24-119</b> orange      |
| <b>24-116</b> green | <b>24-120</b> lavender    |
|                     | <b>24-121</b> bright pink |



For small plaster dressings



**24-122**  
160 mm



**24-123 - 124**  
ESMARCH  
200 mm 230 mm



**24-125**  
BERGMANN  
230 mm



**24-126**  
BRUNS  
235 mm



**24-127**  
235 mm

also to be used as  
bandage scissors



**24-128**  
SEUTIN  
230 mm

also to be used as  
bandage scissors



**24-129**  
STILLE-AESCALAP  
260 mm



**24-130**  
STILLE-AESCALAP  
360 mm



Blade with reinforced back



**24-131**  
STILLE  
230 mm

**24-132**  
Spare blade



**24-133**  
STILLE  
370 mm

**24-134**  
Spare blade



**24-135**  
STILLE  
240 mm

**24-136**  
Spare blade



1/3

**24-137**  
HENING  
270 mm



1/3

**24-138**  
MOD.USA  
230 mm



1/3

**24-139**  
290 mm



with removable jaws



1/3

**24-140 - 141**  
WOLFF  
**24-140** 180 mm  
**24-141** 240 mm

# Vacuum Currettes for Aspiration Lipectomy, Suction Instruments



**25-101 - 106**  
BIEMER  
25-101 ø 4 mm  
25-102 ø 6 mm  
25-103 ø 8 mm  
25-104 ø 10 mm  
25-105 ø 12 mm  
25-106 ø 14 mm  
Currettes for aspiration lipectomy, graduated, slightly curved

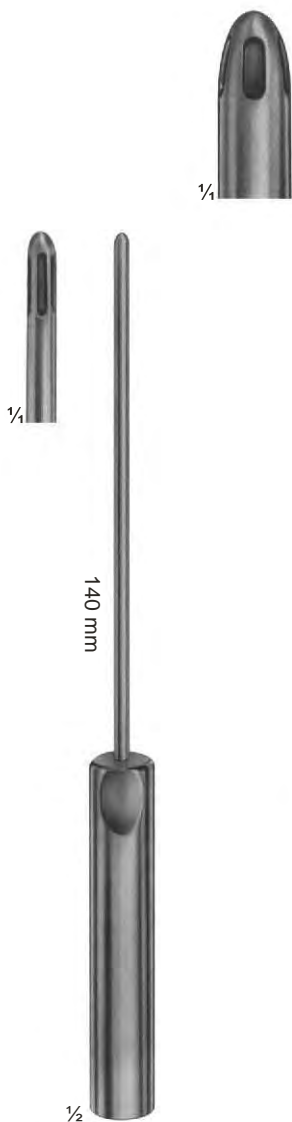

**25-107 - 108**  
BIEMER  
25-107 ø 4 mm  
25-108 ø 6 mm  
Currettes for aspiration lipectomy, with three apertures, slightly curved malleable



**25-109 - 111**  
BIEMER  
25-109 ø 8 mm  
25-110 ø 10 mm  
25-111 ø 12 mm  
Currettes for aspiration lipectomy, with three apertures, slightly curved malleable



**25-112**  
For aspirating fluid from the excretory ducts of large glands and for keeping the operating area clear 170 mm



**25-113**  
Trocar  
For puncturing 150 mm



**25-114**  
For clearing large quantities of fluid 190 mm



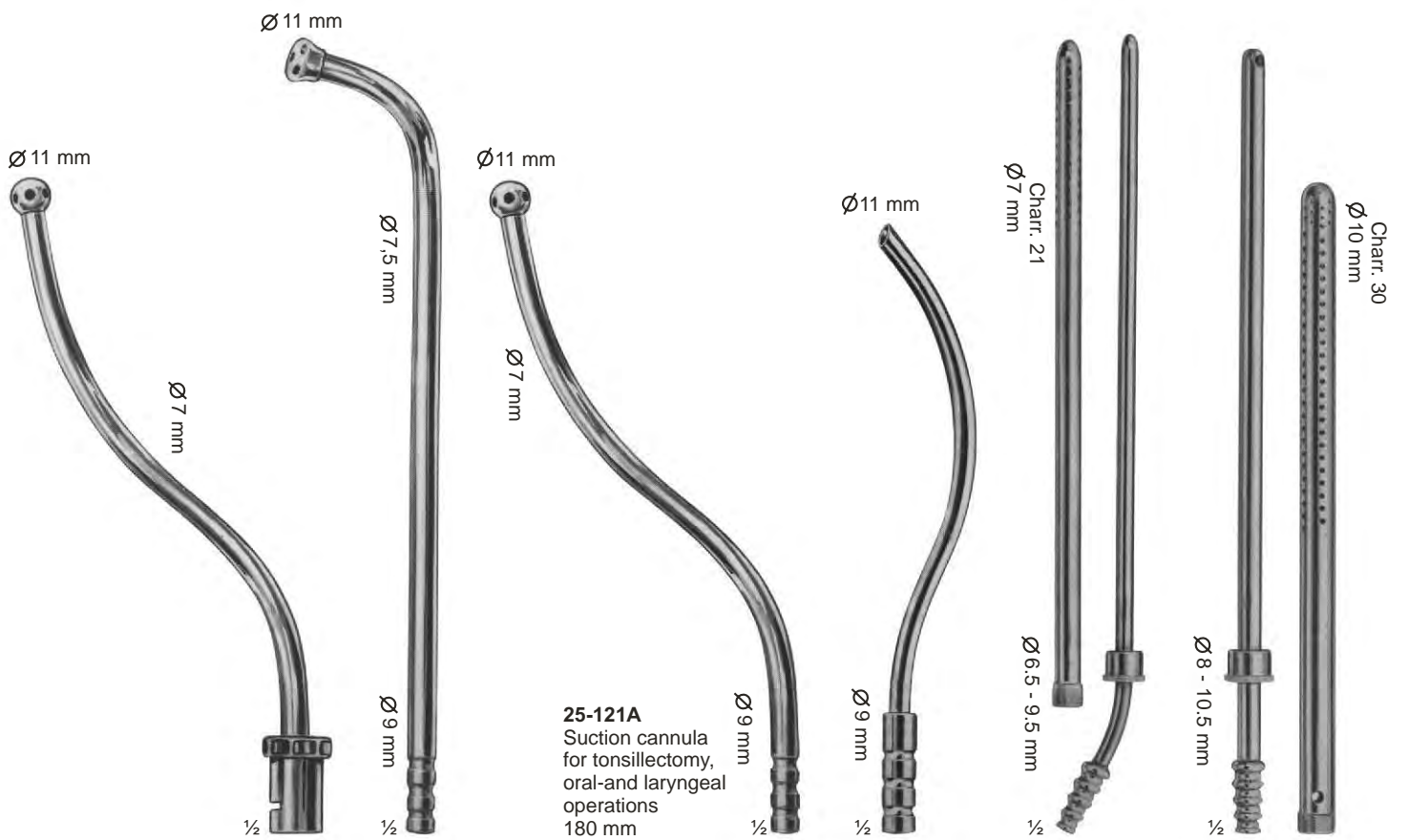

**25-120**  
For tonsillectomy,  
oral-and laryngeal  
operations  
180 mm

**25-121**  
Suction cannula  
for tonsillectomy,  
oral-and laryngeal  
operations  
220 mm

**25-121A**  
Suction cannula  
for tonsillectomy,  
oral-and laryngeal  
operations  
180 mm

**25-122**  
S-shaped blunt cannula  
for aspirating fluid from  
the excretory ducts of  
large glands and for  
keeping the operations  
area clear  
170 mm

**25-123**  
POOL  
Suction cannula,  
with outer tube  
to be screwed of  
225 mm

**25-124**  
POOL  
Suction cannula,  
with outer tube  
to be screwed of  
225 mm

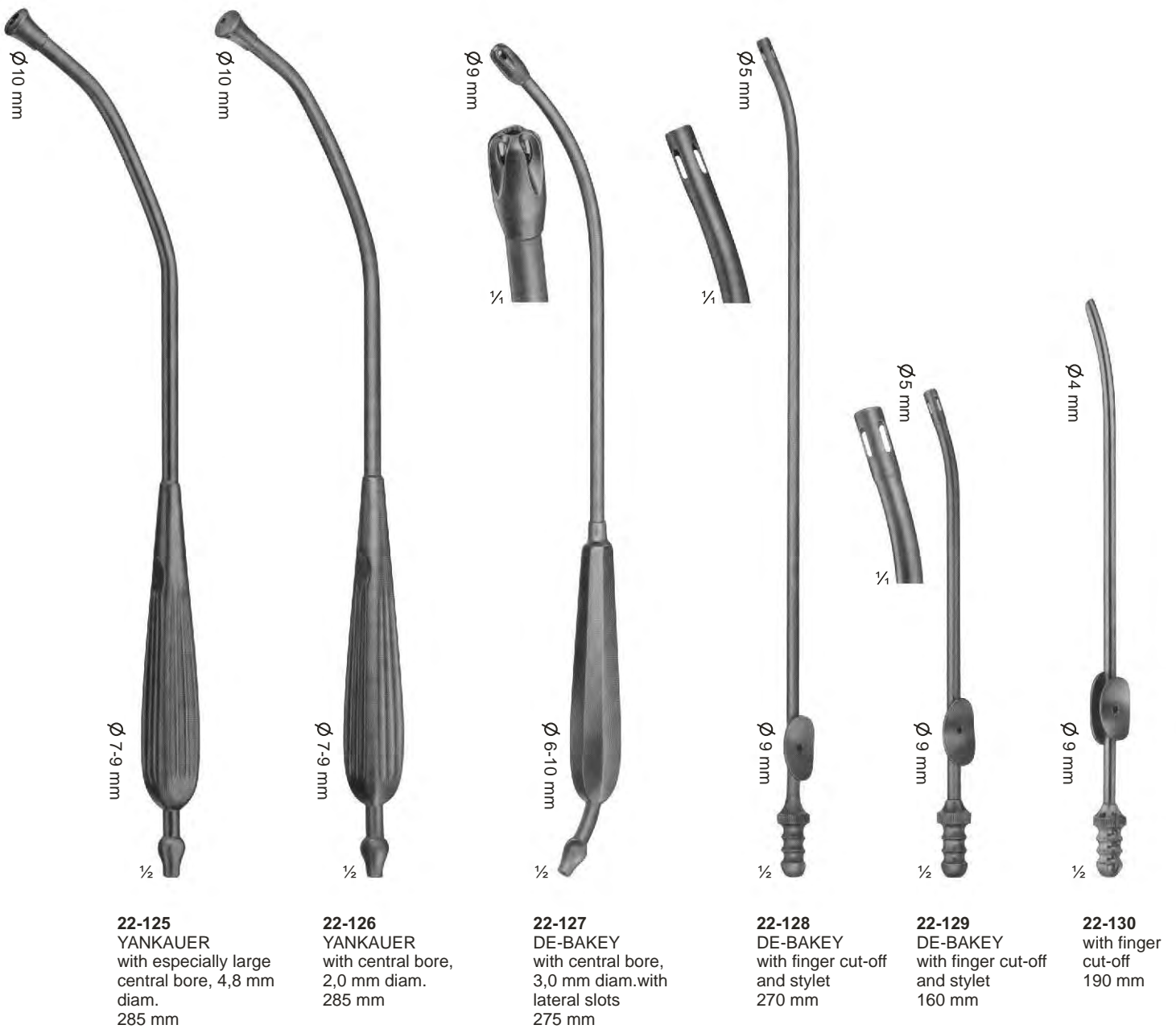

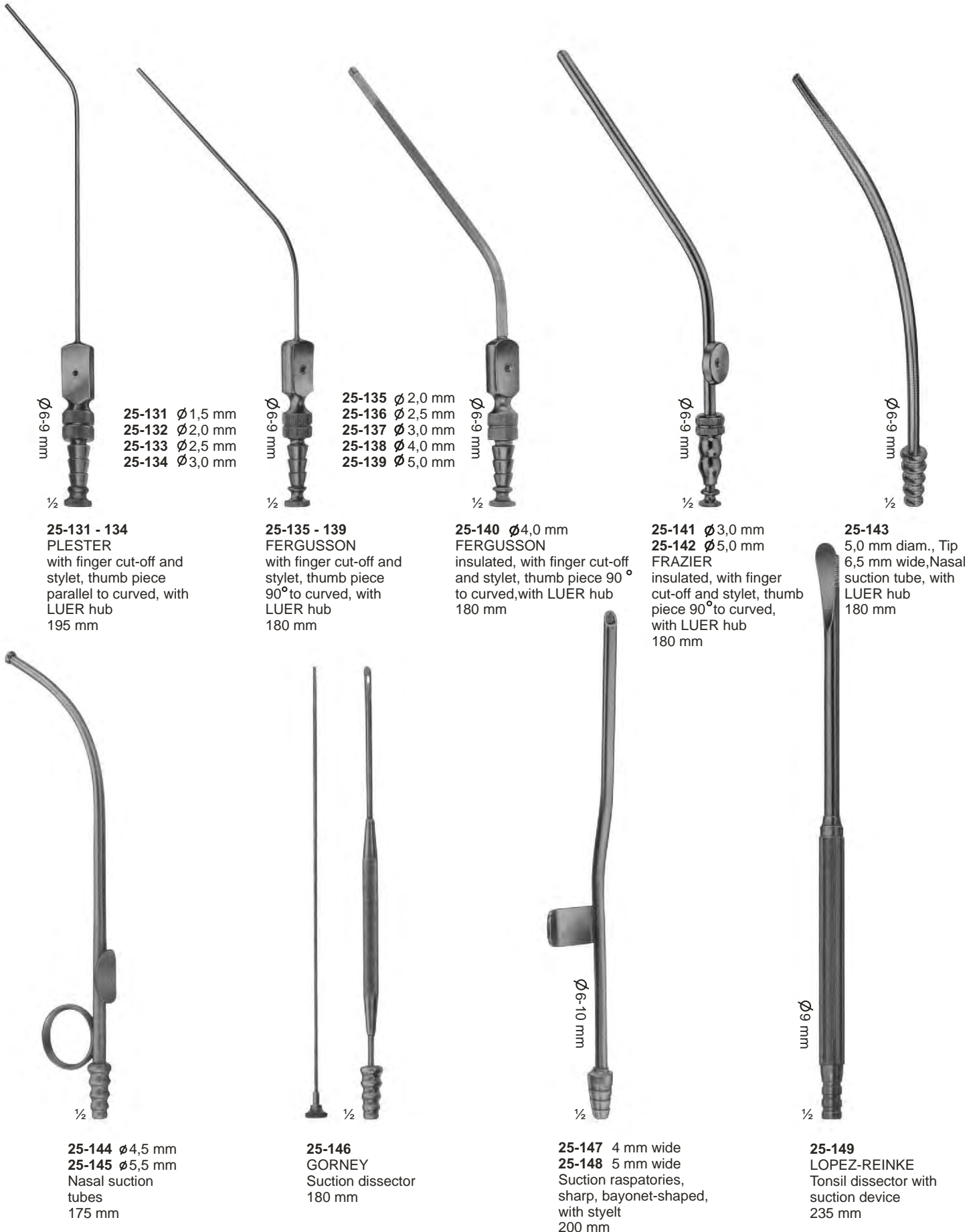



**25-150**  
WULLSTEIN  
Suction tube, conical, silver, oliver  
with LUER hub  
160 mm

$\varnothing 1,75$  mm

$\varnothing 3$  mm  
 $\frac{1}{2}$   
 $\varnothing 8$  mm

**25-151** 1,5 mm  
**25-152** 2,0 mm  
WULLSTEIN  
Suction tube, cylindrical, silver, with  
stylet with LUER hub  
160 mm

$\frac{1}{2}$   
 $\varnothing 8$  mm

Usable length

YASARGIL usable length diam.		YASARGIL usable length diam.	
<b>25-153</b>	130 mm 1,5 mm	<b>25-161</b>	130 mm 2,5 mm
<b>25-154</b>	150 mm 1,5 mm	<b>25-162</b>	150 mm 2,5 mm
<b>25-155</b>	180 mm 1,5 mm	<b>25-163</b>	180 mm 2,5 mm
<b>25-156</b>	220 mm 1,5 mm	<b>25-164</b>	220 mm 2,5 mm
<b>25-157</b>	130 mm 2,0 mm	<b>25-165</b>	130 mm 3,5 mm
<b>25-158</b>	150 mm 2,0 mm	<b>25-166</b>	150 mm 3,5 mm
<b>25-159</b>	180 mm 2,0 mm	<b>25-167</b>	180 mm 3,5 mm
<b>25-160</b>	220 mm 2,0 mm	<b>25-168</b>	220 mm 3,5 mm
		<b>25-169</b>	180 mm 4,5 mm

$\varnothing 6,5-9$  mm  
with LUER hub

**25-170 - 172**  
LANDOLT  
150 MM  
diam  $\varnothing 3$  mm

**25-170** 8 mm / curved  
**25-171** 11mm / curved  
**25-172** 15mm / curved

$\frac{1}{2}$   
 $\frac{1}{2}$

$\varnothing 3.5$  mm

$\varnothing 2.0$  mm

**25-173** 500 mm  
**25-174** 350 mm  
with rubber tip,  
with LUER hub

$\varnothing 9$  mm  
 $\frac{1}{2}$

**25-175** 2,0 mm diam  
**25-176** 2,5 mm diam  
**25-177** 3,0 mm diam  
with finger cut-off,  
thumb piece 90° to  
curved, with LUER hub  
250 mm

$\varnothing 6.9$  mm  
 $\frac{1}{2}$

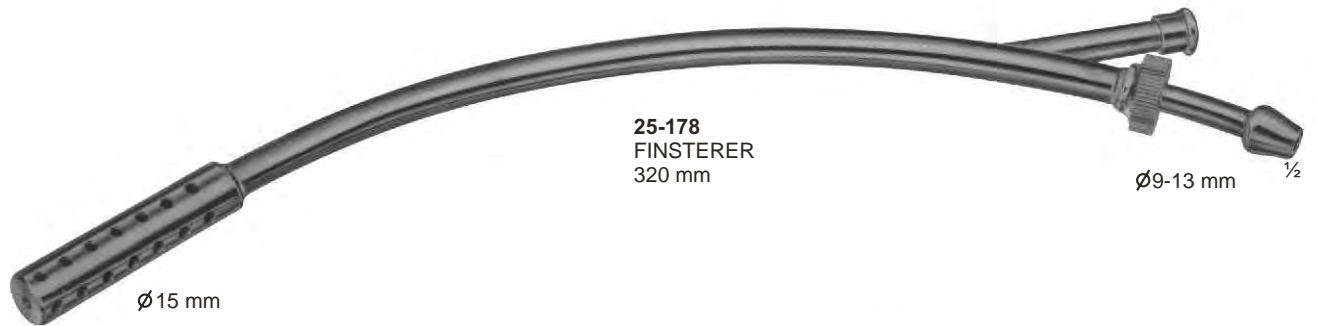

**25-178**  
FINSTERER  
320 mm

ø9-13 mm 1/2

ø 15 mm



ø 2 mm

ø 4,5 mm

**25-179**  
YASARGIL  
LURE-LOCK cone  
200 mm

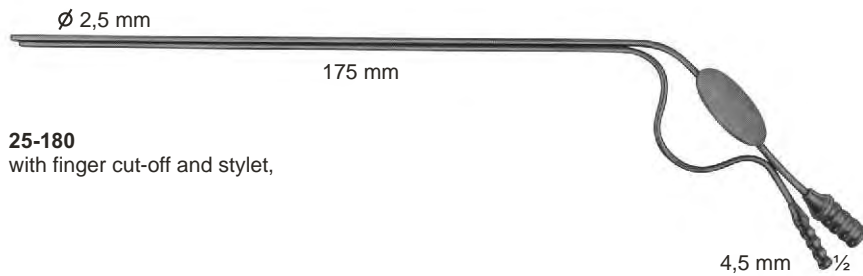

ø 2,5 mm

175 mm

**25-180**  
with finger cut-off and stylet,

4,5 mm 1/2

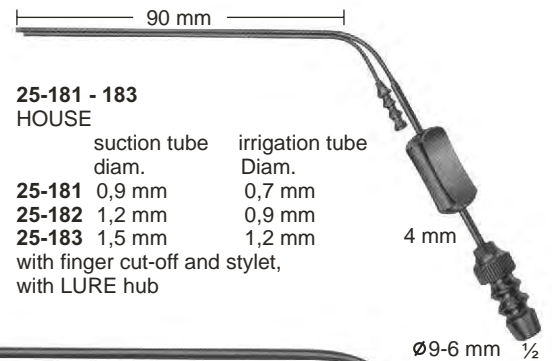

90 mm

**25-181 - 183**  
HOUSE

	suction tube diam.	irrigation tube Diam.
<b>25-181</b>	0,9 mm	0,7 mm
<b>25-182</b>	1,2 mm	0,9 mm
<b>25-183</b>	1,5 mm	1,2 mm

with finger cut-off and stylet, with LURE hub

4 mm

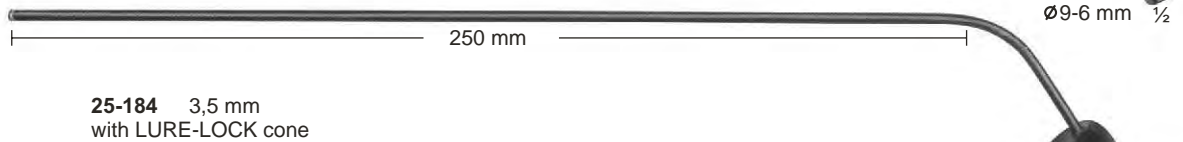

**25-184** 3,5 mm  
with LURE-LOCK cone

250 mm

ø9-6 mm 1/2

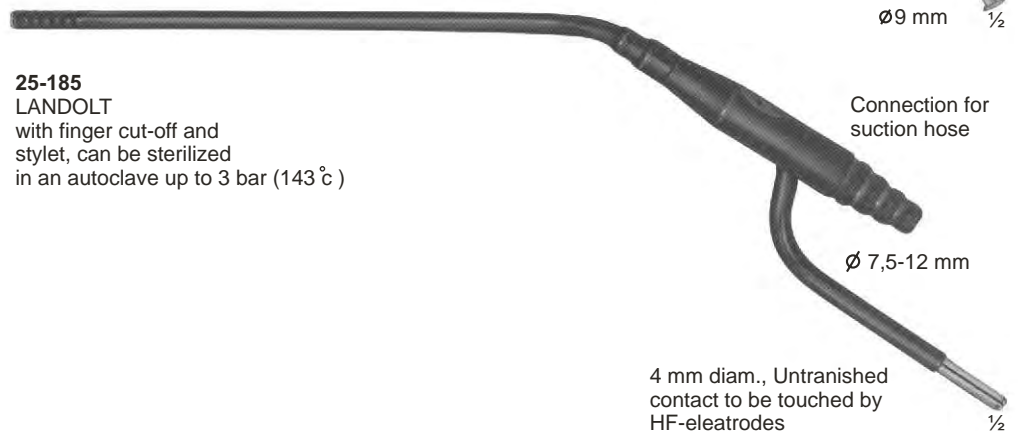

**25-185**  
LANDOLT  
with finger cut-off and stylet, can be sterilized in an autoclave up to 3 bar (143 °C)

Connection for suction hose

ø 7,5-12 mm

4 mm diam., Untrashed contact to be touched by HF-electrodes

1/2



**26-101**  
Standard

14,5cm  
16,5cm  
18,5cm



**26-102**  
Standard

14,5cm  
16,5cm  
18,5cm



**26-103**  
Standard

14,5cm  
16,5cm  
18,5cm



**26-104**  
Standard

14,5cm  
16,5cm  
18,5cm



**26-105**  
Standard

14,5cm  
16,5cm  
18,5cm



**26-106**  
Standard

14,5cm  
16,5cm  
18,5cm



**26-107**  
Mayo-Lexer

16cm



**26-108**  
Mayo-Lexer

16cm



**26-109**  
Lexer

16cm  
21cm



**26-110**  
Lexer

16cm  
21cm



**26-111**  
Mayo-Stille

15cm  
17cm



**26-112**  
Mayo-Stille

15cm  
17cm



**26-113**  
Metzenbaum



18cm 11,5cm  
20cm 14,5cm  
28cm 23,5cm  
30cm 25,5cm



**26-114**  
Metzenbaum



11,5cm 14,5cm  
23cm 25cm

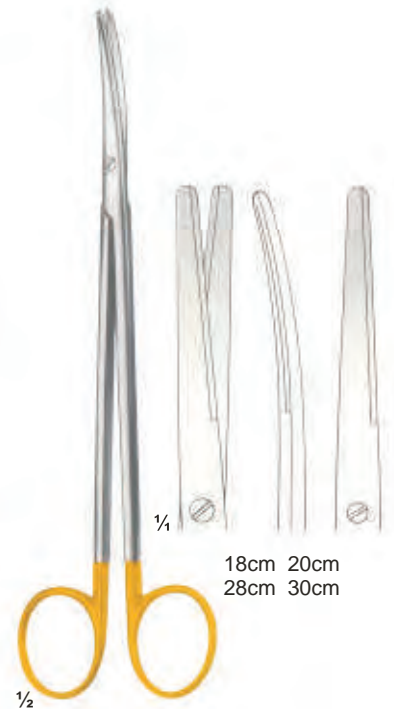

**26-115**  
Metzenbaum



18cm 20cm  
28cm 30cm



**26-116**  
Metzenbaum-Fino



14cm 18cm 20cm  
23cm 25cm 28cm



**26-117**  
Metzenbaum-Fino



14cm 18cm 20cm  
23cm 25cm 28cm



**26-118**  
Metzenbaum-Fino



14cm 18cm  
20cm 23cm



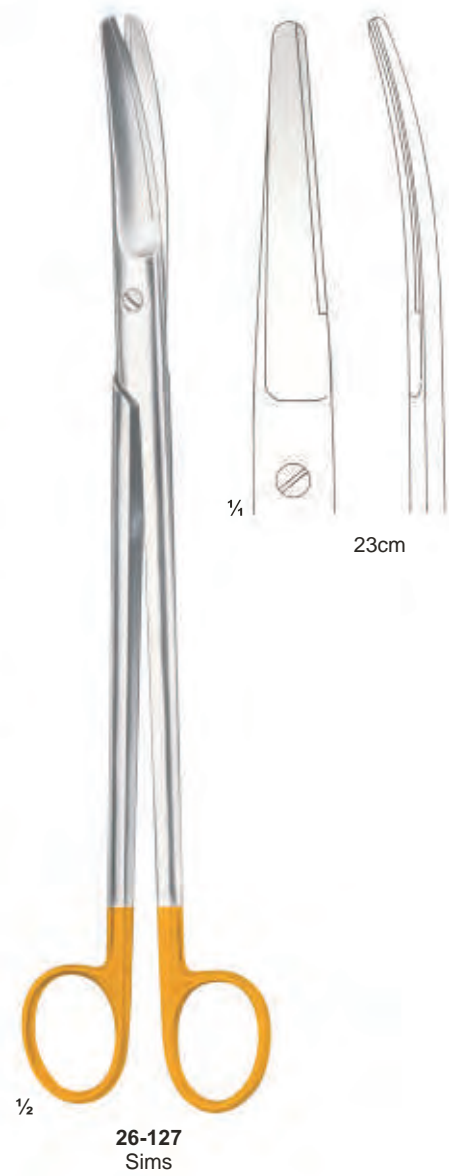
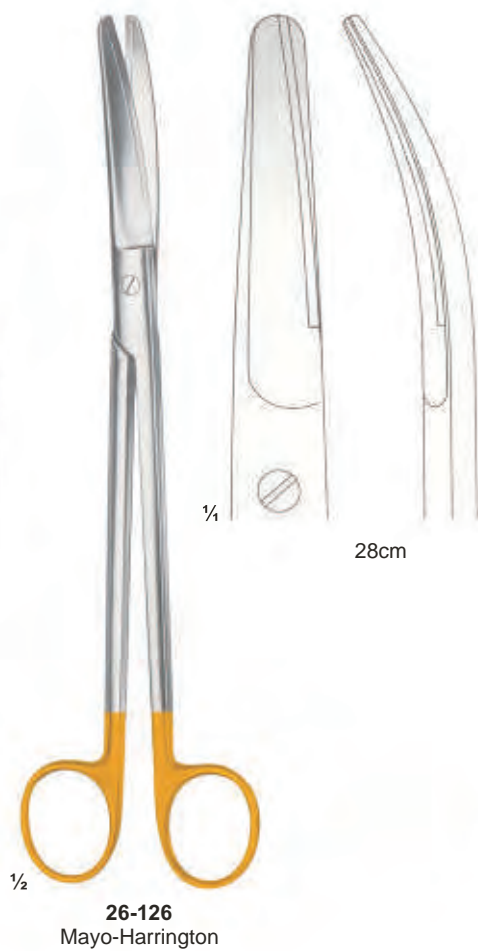

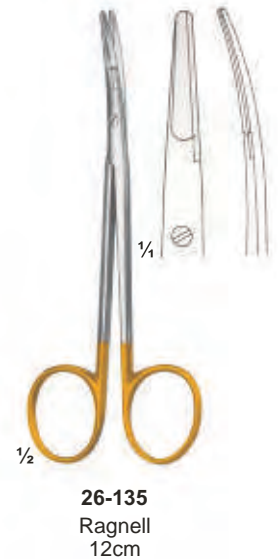
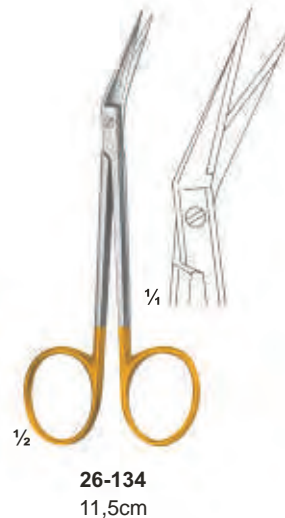
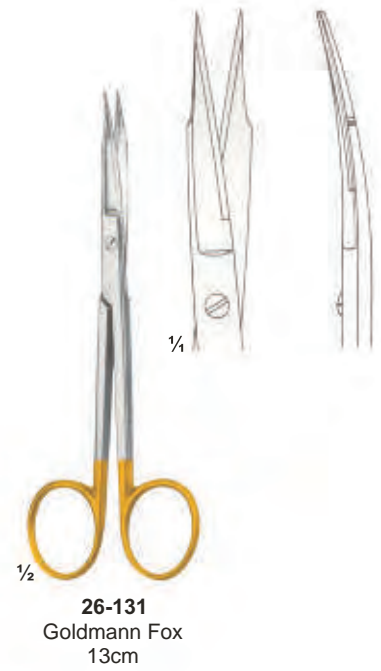
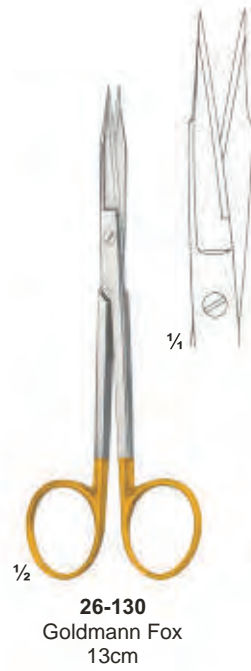

# Scissors & Dissecting Forceps with Tungsten Carbide Inserts

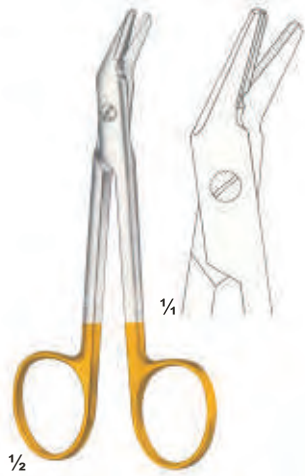

**26-136**  
Universal  
12cm



**26-137**  
Ligature Scissors  
1 Black & 1 Goldplated ring

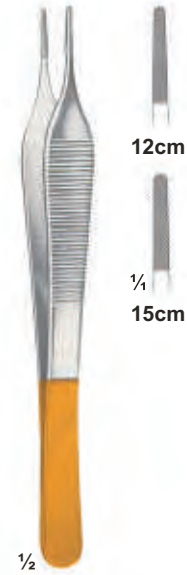

**26-138**  
Adson



**26-139**  
Cushing  
17,5cm



**26-140**  
Cushing  
18cm



**26-141**  
Cushing-Taylor  
18cm



**26-142**  
Dissecting Forceps  
15cm



**26-143**  
Semken  
15cm

# Dissecting Forceps and Needle holders with Tungsten Carbide Inserts

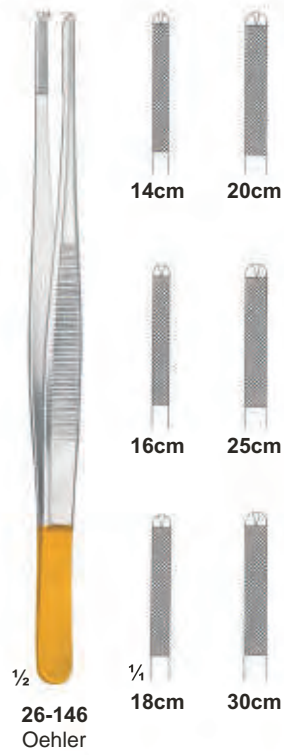
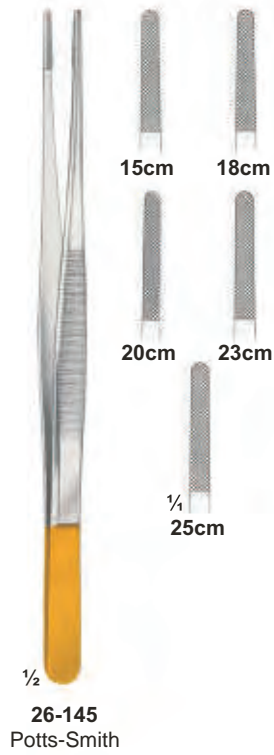

# Needle holders with Tungsten Carbide Inserts



**26-152**  
Arruga  
16cm



**26-153**  
Castroviejo  
13cm



**26-154**  
Hegar  
20cm 24cm

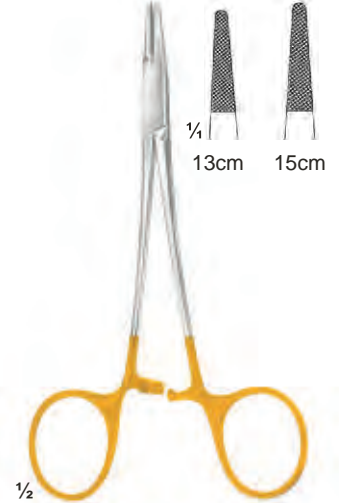

**26-155**  
Halsey  
13cm 15cm

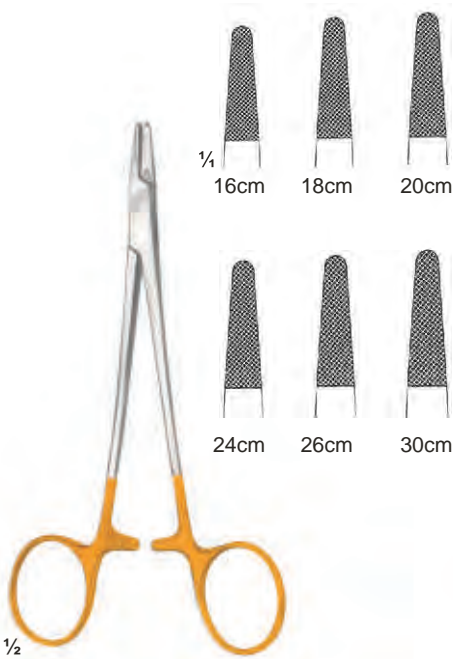

**26-156**  
Mayo-Hegar  
16cm 18cm 20cm  
24cm 26cm 30cm

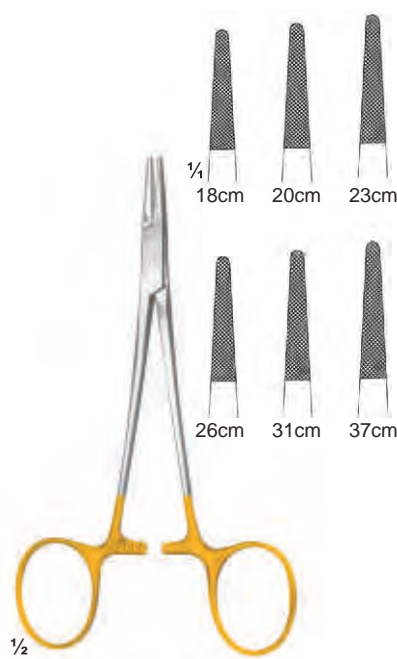

**26-157**  
De-Bakey  
18cm 20cm 23cm  
26cm 31cm 37cm

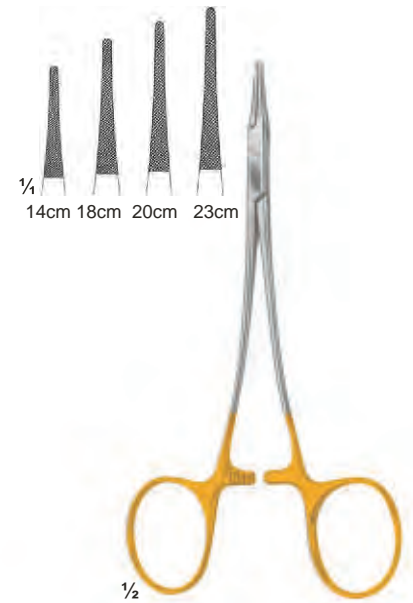

**26-158**  
Hegar-Vascular  
14cm 18cm  
20cm 23cm

# Needle holders with Tungsten Carbide Inserts



1/2  
**26-159**  
Bozemann-Wertheim  
20cm 24cm 26cm



1/4  
22cm 23cm  
1/2  
**26-160**  
Stratte  
22cm 23cm



1/4  
13cm 15cm  
18cm 20cm  
23cm 26cm  
1/2  
**26-161**  
Ryder  
13cm 15cm 18cm  
20cm 23cm 26cm



1/4  
13cm 15cm 18cm  
20cm 23cm 26cm  
1/2  
**26-162**  
Ryder-Vascular  
13cm 15cm 18cm  
20cm 23cm 26cm



1/4  
15cm 17cm 20cm  
1/2  
**26-163**  
Martin  
15cm 17cm 20cm



1/4  
18cm 20cm 26cm  
1/2  
**26-164**  
Sarot  
18cm 20cm 26cm

# Needle holders with Tungsten Carbide Inserts



# Needle holders with Tungsten Carbide Inserts



1/2  
**26-172**  
Mathieu-Ryder  
17cm  
20cm 24cm



1/2  
**26-173**  
Lichtenberg  
20cm



1/2  
**26-174**  
Langhals  
20cm 25cm



1/2  
**26-175**  
Lichtenberg  
20cm 25cm



1/2  
**26-176**  
Luehty-Beck  
20cm 25cm



1/2  
**26-177**  
Luehty-Beck  
20cm 25cm



1/2  
**26-178**  
Langebeck  
18cm  
20cm 23cm



1/2  
**26-179**  
Langebeck-beck  
18cm  
20cm 23cm



**27-101 - 115**  
Schimmelbusch

	Ø x H sizes in mm
<b>27-101</b>	80 x 80
<b>27-102</b>	105 x 120
<b>27-103</b>	140 x 140
<b>27-104</b>	160 x 120
<b>27-105</b>	160 x 150
<b>27-106</b>	190 x 150
<b>27-107</b>	190 x 190
<b>27-108</b>	240 x 160
<b>27-109</b>	240 x 240
<b>27-110</b>	290 x 160
<b>27-111</b>	290 x 240
<b>27-112</b>	340 x 160
<b>27-113</b>	340 x 340
<b>27-114</b>	390 x 190
<b>27-115</b>	390 x 290



**27-116**  
Box  
120 x 65 x 13mm  
(without Bulldog clamps,  
without silicone tape)



**27-117**  
Box with support  
120 x 65 x 13 mm  
(ohne Bulldogklemmen)



**27-118**  
Box with support for  
needle electrodes,  
without instruments



**27-119 - 121**  
50 x 25 x 4,5 mm  
**27-120**  
65 x 42 x 8 mm  
**27-121**  
75 x 25 x 4,5 mm

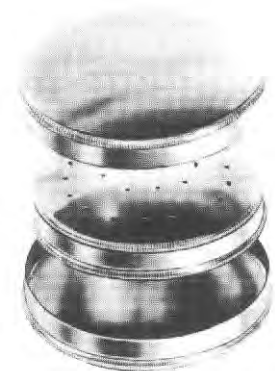

**27-122**  
Ø 65mm x 15mm



**27-123 - 131**

	Ø x H
<b>27-123</b>	30 x 90 mm
<b>27-124</b>	50 x 100 mm
<b>27-125</b>	50 x 130 mm
<b>27-126</b>	50 x 175 mm
<b>27-127</b>	75 x 100 mm
<b>27-128</b>	75 x 130 mm
<b>27-129</b>	75 x 175 mm
<b>27-130</b>	100 x 175 mm
<b>27-131</b>	100 x 200 mm



**27-132 - 139**

<b>27-132</b>	165 x 85 x 35 mm
<b>27-133</b>	200 x 100 x 35 mm
<b>27-134</b>	200 x 100 x 50 mm
<b>27-135</b>	230 x 130 x 50 mm
<b>27-136</b>	260 x 150 x 50 mm
<b>27-137</b>	270 x 235 x 50 mm
<b>27-138</b>	300 x 200 x 50 mm
<b>27-139</b>	325 x 275 x 50 mm



**27-140**  
205 x 105 x 35 mm



## 27-141 - 142

- 27-141** Martin Sterilizing Forceps  
consisting of:  
1 Sterilizing Forceps, curved, 25 cm,  
without ratchet, with lid for jar  
1 jar with bottom plate (anti-tilt)
- 27-142** ditto, with 32 cm long Sterilizing Forceps



**27-143 - 148**

Ø x H

<b>27-143</b>	75 x 60 mm
<b>27-144</b>	75 x 75 mm
<b>27-145</b>	100 x 60 mm
<b>27-146</b>	100 x 100 mm
<b>27-146A</b>	125 x 80 mm
<b>27-147</b>	125 x 125 mm
<b>27-148</b>	150 x 150 mm

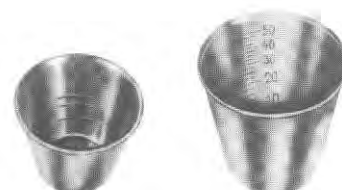

**27-149**  
25 cc

**27-150**  
50 cc

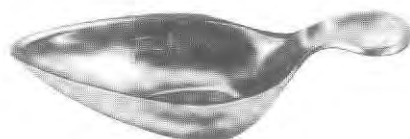

**27-151**  
20 cc  
Medicine Spoon



**27-152**  
Ø75 x 12 mm  
Tablet Tray



**27-153**  
Ø90 x 90 mm  
Metal Cup



**27-154**  
Ø75 x 80 mm  
Sputum Cup

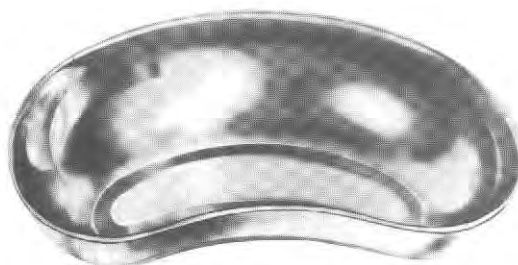

**Kidney Dish**

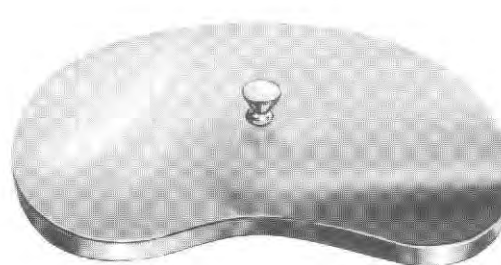

**27-155 - 157**

<b>27-155</b>	170 x 100 x 35 mm
<b>27-156</b>	250 x 140 x 40 mm
<b>27-157</b>	275 x 150 x 45 mm

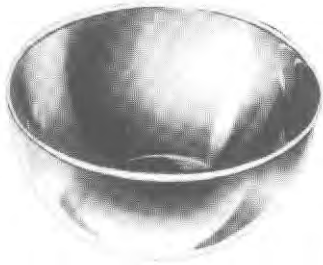

**27-158 - 165**

	Ø x H	
<b>27-158</b>	40 x 19 mm	0.05L
<b>27-159</b>	61 x 30 mm	0.07L
<b>27-160</b>	80 x 40 mm	0.14L
<b>27-161</b>	116 x 50 mm	0.35L
<b>27-162</b>	128 x 55 mm	0.45L
<b>27-163</b>	147 x 65 mm	0.70L
<b>27-164</b>	167 x 75 mm	1.10L
<b>27-165</b>	187 x 85 mm	1.60L

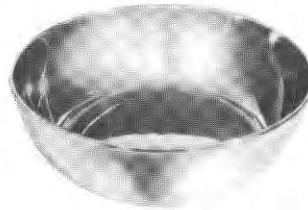

**27-166 - 170**

<b>27-166</b>	116 x 35 mm	0.30L
<b>27-167</b>	128 x 38 mm	0.40L
<b>27-168</b>	147 x 40 mm	0.50L
<b>27-169</b>	157 x 45 mm	0.75L
<b>27-170</b>	187 x 45 mm	1.00L



**27-171**  
Ø 110 x 28 mm 0.15L



**27-172**  
100 cc 0.1L



**27-173 - 176**

<b>27-173</b>	0,25L
<b>27-174</b>	0,50L
<b>27-175</b>	1,00L
<b>27-176</b>	2,00L

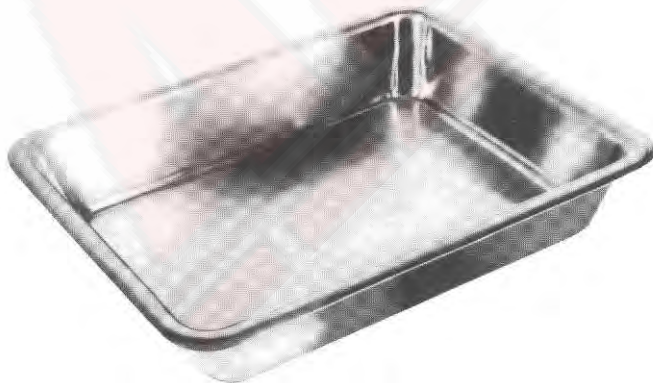

**27-177**  
235 x 190 x 40 mm



**27-178**  
Ø220 x 70 mm



**27-179**  
 Ø 50 x 100 mm  
 Powder Pot



**27-180**  
 Ø 50 x 75 mm  
 Methot With Lid



**27-181**  
 Ø 50 x 75 mm  
 Methot Without Lid

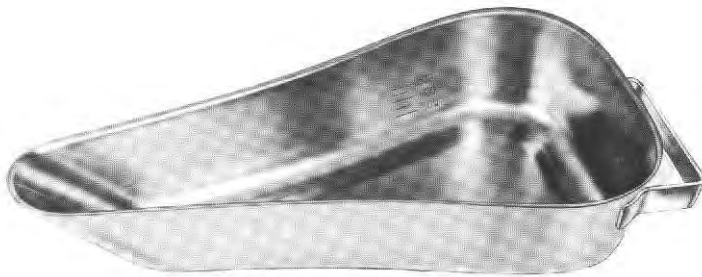

**27-182**

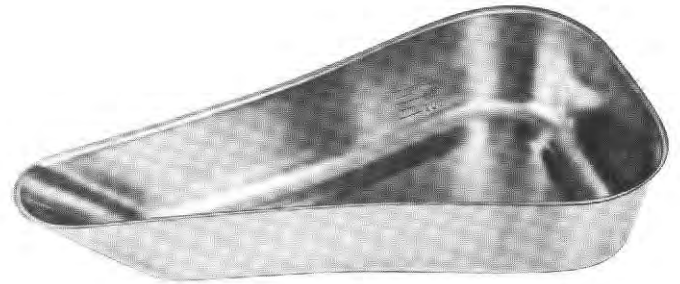

**27-183**

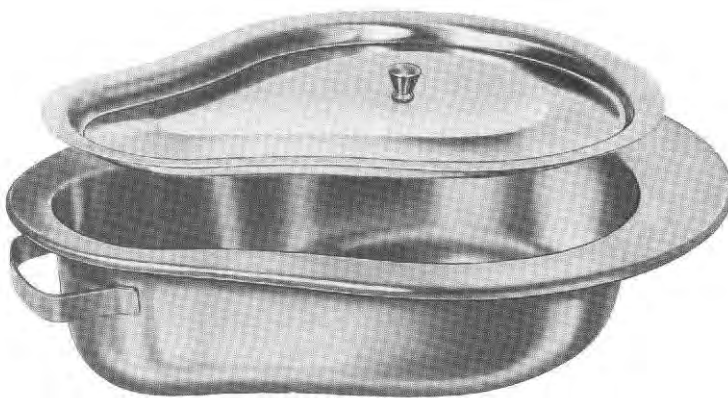

**27-184**

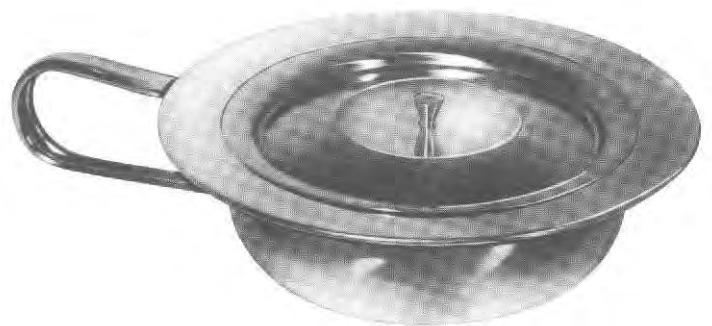

**27-185 - 186**

**27-185** Ø 235 mm  
**27-186** Ø 310 mm



**27-187**  
Sauerbruch  
210 x 125 x 17 mm



**27-188**  
Sauerbruch  
210 x 125 x 17 mm



**27-189**  
150 x 95 x 13 mm



**27-190**  
150 x 95 x 13 mm



**27-191**  
150 x 95 x 13 mm



**27-192**  
150 x 95 x 13 mm



**27-193**  
150 x 95 x 13 mm



**27-194**  
150 x 95 x 13 mm

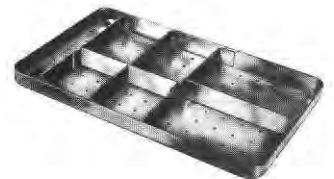

**27-195**  
150 x 95 x 11 mm



**27-196**  
Deponette  
245 x 135 x 35mm



**27-197**  
Deponette  
245 x 135 x 50mm

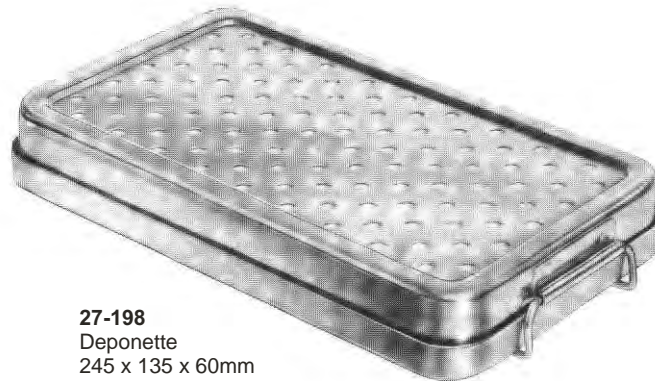

**27-198**  
Deponette  
245 x 135 x 60mm

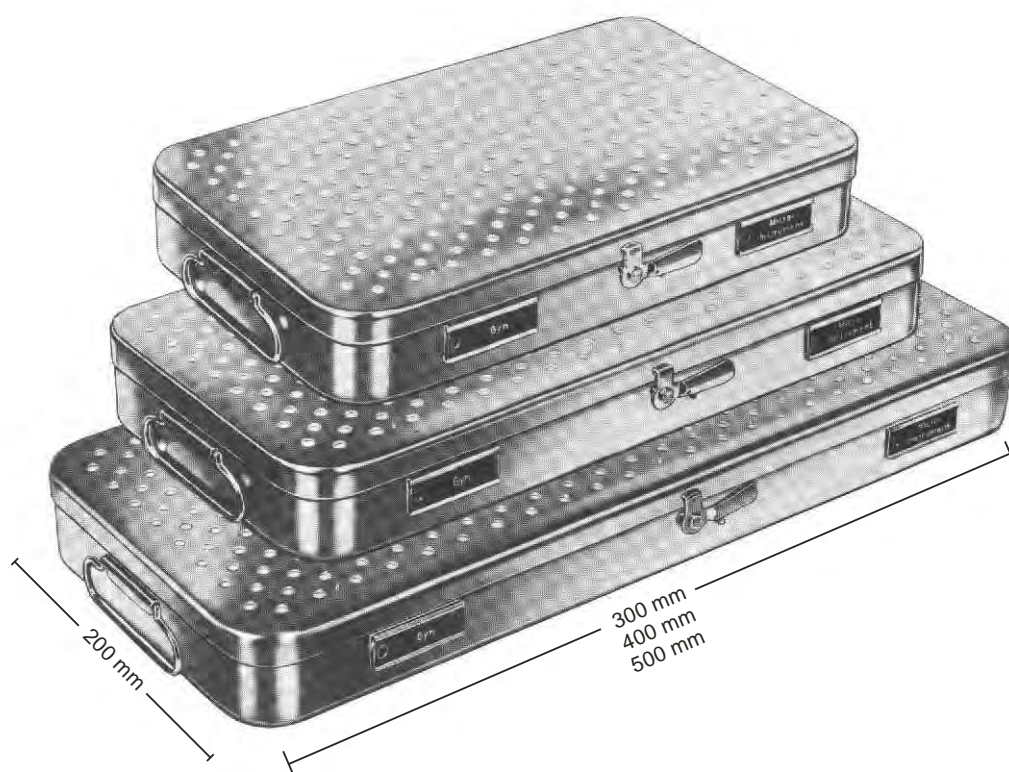

**27-199 - 209**

<b>27-199</b>	230 x 130 x 50	mm
<b>27-200</b>	260 x 150 x 50	mm
<b>27-201</b>	275 x 235 x 50	mm
<b>27-202</b>	300 x 200 x 50	mm
<b>27-203</b>	325 x 275 x 50	mm
<b>27-204</b>	420 x 175 x 50	mm
<b>27-205</b>	230 x 130 x 75	mm
<b>27-206</b>	260 x 150 x 75	mm
<b>27-207</b>	300 x 200 x 75	mm
<b>27-208</b>	325 x 275 x 75	mm
<b>27-209</b>	420 x 175 x 75	mm

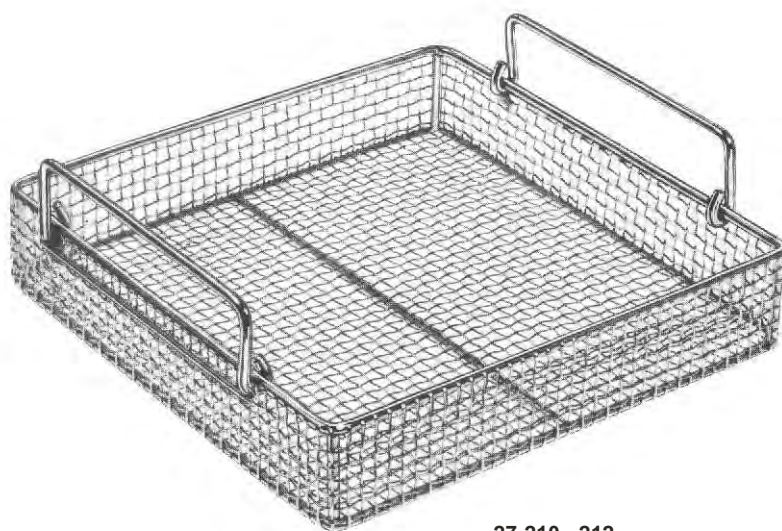

27-210 - 212

<b>27-210</b>	480 x 250 x 50	mm
<b>27-211</b>	520 x 250 x 75	mm
<b>27-212</b>	520 x 250 x 100	mm



27-213 - 218

<b>27-213</b>	240 x 240 x 50	mm
<b>27-214</b>	240 x 240 x 80	mm
<b>27-215</b>	240 x 240 x 100	mm
<b>27-216</b>	480 x 260 x 50	mm
<b>27-217</b>	520 x 260 x 80	mm
<b>27-218</b>	520 x 260 x 100	mm

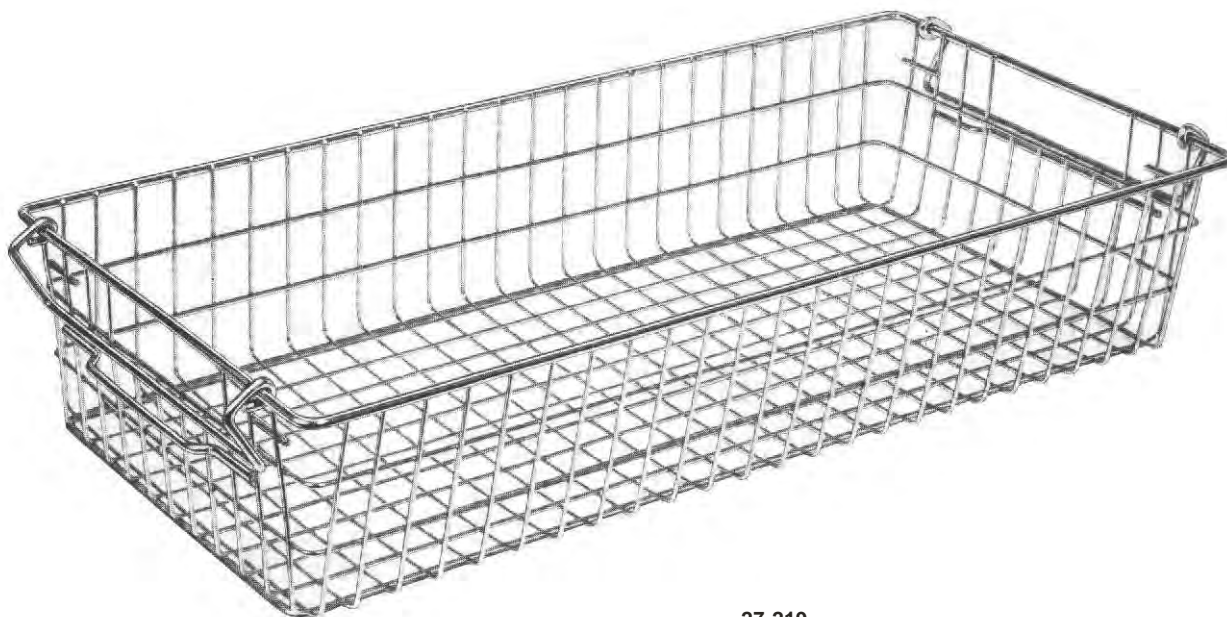

**27-219**  
(60 x 30 x 15 cm)  
Nominal dimensions